

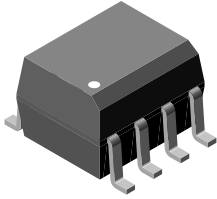

Optocoupler, Phototransistor Output, Dual Channel, SOIC-8 Package

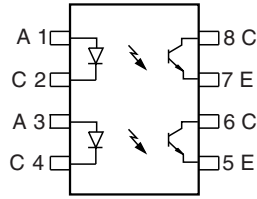

I179018



DESCRIPTION

The VOD205T, VOD206T, VOD207T, VOD211T, VOD213T, VOD217T are optically coupled pairs with a gallium arsenide infrared LED and a silicon NPN phototransistor. Signal information, including a DC level, can be transmitted by the device while maintaining a high degree of electrical isolation between input and output.

FEATURES

- Two channel coupler
- SOIC-8 surface mountable package
- Standard lead spacing of 0.05"
- Available only on tape and reel option (conforms to EIA standard 481-2)
- Isolation test voltage, 4000 V_{RMS}
- Compatible with dual wave, vapor phase and IR reflow soldering
- Lead (Pb)-free component
- Component in accordance to RoHS 2002/95/EC and WEEE 2002/96/EC



RoHS COMPLIANT

AGENCY APPROVALS

- UL1577, file no. E52744 system code Y
- CUL - file no. E52744, equivalent to CSA bulletin 5A
- DIN EN 60747-5-5 (VDE 0884) available with option 1

ORDER INFORMATION	
PART	REMARKS
VOD205T	CTR 40 % to 80 %, SOIC-8
VOD206T	CTR 63 % to 125 %, SOIC-8
VOD207T	CTR 100 % to 200 %, SOIC-8
VOD211T	CTR > 20 %, SOIC-8
VOD213T	CTR > 100 %, SOIC-8
VOD217T	CTR > 100 %, SOIC-8

ABSOLUTE MAXIMUM RATINGS (1)				
PARAMETER	TEST CONDITION	SYMBOL	VALUE	UNIT
INPUT				
Peak reverse voltage		V _R	6	V
Peak pulsed current	1 μs, 300 pps	I _{FM}	1	A
Continuous forward current per channel		I _F	30	mA
Power dissipation		P _{diss}	50	mW
Derate linearly from 25 °C			0.66	mW/°C
OUTPUT				
Collector emitter breakdown voltage		BV _{CEO}	70	V
Emitter collector breakdown voltage		BV _{ECO}	7	V
Continuous output current		I _{Cmax.}	50	mA
Power dissipation per channel		P _{diss}	125	mW
Derate linearly from 25 °C			1.67	mW/°C

VOD205T, VOD206T, VOD207T, VOD211T, VOD213T, VOD217T



Vishay Semiconductors

Optocoupler, Phototransistor
Output, Dual Channel,
SOIC-8 Package

ABSOLUTE MAXIMUM RATINGS (1)				
PARAMETER	TEST CONDITION	SYMBOL	VALUE	UNIT
COUPLER				
Isolation test voltage	t = 1 s	V _{ISO}	4000	V _{RMS}
Total package dissipation ambient (2 LEDs and 2 detectors, 2 channels)		P _{tot}	300	mW
Derate linearly from 25 °C			4	mW/°C
Storage temperature		T _{stg}	- 40 to + 150	°C
Operating temperature		T _{amb}	- 40 to + 100	°C
Soldering time from 260 °C (2)		T _{slid}	10	s

Notes

(1) T_{amb} = 25 °C, unless otherwise specified.

Stresses in excess of the absolute maximum ratings can cause permanent damage to the device. Functional operation of the device is not implied at these or any other conditions in excess of those given in the operational sections of this document. Exposure to absolute maximum ratings for extended periods of the time can adversely affect reliability.

(2) Refer to reflow profile for soldering conditions for surface mounted devices.

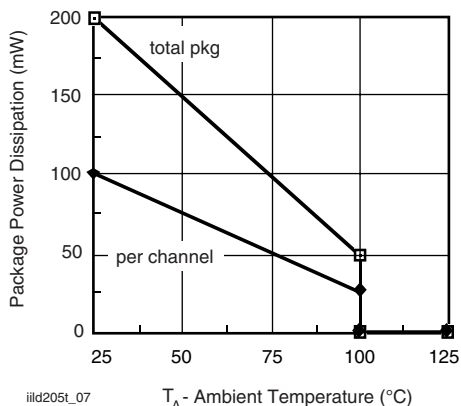

Fig. 1 - Power Dissipation vs. Ambient Temperature

ELECTRICAL CHARACTERISTICS							
PARAMETER	TEST CONDITION	PART	SYMBOL	MIN.	TYP.	MAX.	UNIT
INPUT							
Forward voltage	I _F = 10 mA		V _F		1.2	1.55	V
Reverse current	V _R = 6 V		I _R		0.1	100	μA
Capacitance	V _R = 0 V		C _O		25		pF
OUTPUT							
Collector emitter breakdown voltage	I _C = 100 μA		BV _{CEO}	70			V
Emitter collector breakdown voltage	I _E = 100 μA		BV _{ECO}	7			V
Collector emitter leakage current	V _{CE} = 10 V, I _F = 0 A		I _{CEO}		5	50	nA
Collector emitter capacitance	V _{CE} = 0 V		C _{CE}		10		pF
Collector emitter saturation voltage	I _F = 10 mA, I _C = 2.5 mA		V _{CEsat}			0.4	V
COUPLER							
Capacitance (input to output)			C _{IO}		0.5		pF

Note

T_{amb} = 25 °C, unless otherwise specified.

Minimum and maximum values were tested requirements. Typical values are characteristics of the device and are the result of engineering evaluations. Typical values are for information only and are not part of the testing requirements.



VOD205T, VOD206T, VOD207T, VOD211T, VOD213T, VOD217T

Optocoupler, Phototransistor Output, Dual Channel, SOIC-8 Package

Vishay Semiconductors

CURRENT TRANSFER RATIO							
PARAMETER	TEST CONDITION	PART	SYMBOL	MIN.	TYP.	MAX.	UNIT
DC current transfer ratio	$V_{CE} = 5\text{ V}, I_F = 10\text{ mA}$	VOD205T	CTR_{DC}	40		80	%
		VOD206T	CTR_{DC}	63		125	%
		VOD207T	CTR_{DC}	100		200	%
		VOD211T	CTR_{DC}	20			%
		VOD213T	CTR_{DC}	100			%
	$V_{CE} = 5\text{ V}, I_F = 1.0\text{ mA}$	VOD205T	CTR_{DC}	13	30		%
		VOD206T	CTR_{DC}	22	45		%
		VOD207T	CTR_{DC}	34	70		%
		VOD217T	CTR_{DC}	100	120		%

SWITCHING CHARACTERISTICS							
PARAMETER	TEST CONDITION	SYMBOL	MIN.	TYP.	MAX.	UNIT	
Turn-on time	$I_C = 2\text{ mA}, R_L = 100\ \Omega, V_{CC} = 5\text{ V}$	t_{on}		5		μs	
Turn-off time	$I_C = 2\text{ mA}, R_L = 100\ \Omega, V_{CC} = 5\text{ V}$	t_{off}		4		μs	
Rise time	$I_C = 2\text{ mA}, R_L = 100\ \Omega, V_{CC} = 5\text{ V}$	t_r		5		μs	
Fall time	$I_C = 2\text{ mA}, R_L = 100\ \Omega, V_{CC} = 5\text{ V}$	t_f		4		μs	

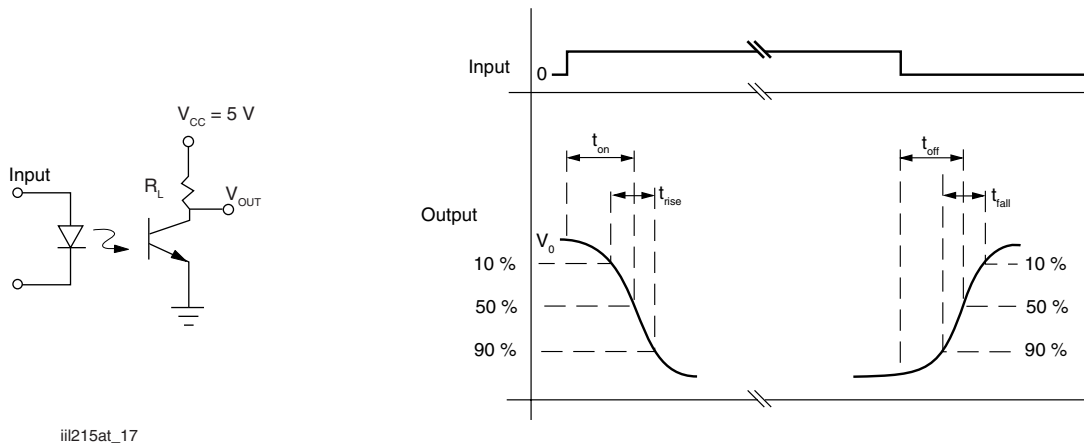

Fig. 2 - Switching Test Circuit

COMMON MODE TRANSIENT IMMUNITY						
PARAMETER	TEST CONDITION	SYMBOL	MIN.	TYP.	MAX.	UNIT
Common mode transient immunity at logic high	$V_{CM} = 1000 V_{P-P}$, $R_L = 1 k\Omega$, $I_F = 0 mA$	$ C_{MH} $		10 000		V/ μs
Common mode transient immunity at logic low	$V_{CM} = 1000 V_{P-P}$, $R_L = 1 k\Omega$, $I_F = 10 mA$	$ C_{ML} $		10 000		V/ μs

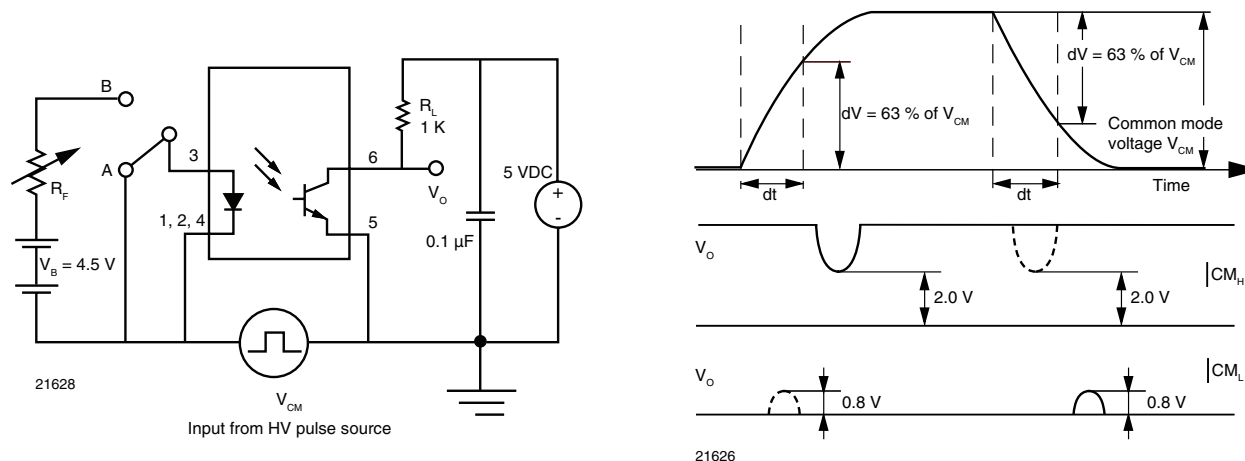

Fig. 3 - Test Circuit for Common Mode Transient Immunity

SAFETY AND INSULATION RATINGS						
PARAMETER	TEST CONDITION	SYMBOL	MIN.	TYP.	MAX.	UNIT
Climatic classification (according to IEC 68 part 1)				40/100/21		
Polulation degree				2		
Comparative tracking index		CTI	175		399	
Peak transient overvoltage		V_{IOTM}	6000			V
Peak insulation voltage		V_{IORM}	560			V
Resistance (input to output)		R_{IO}		100		G Ω
Apparent charge method a		q_{pd}				C
Apparent charge method b		q_{pd}				C
Safety rating - power output		P_{SO}			350	mW
Safety rating - input current		I_{SI}			150	mA
Safety rating - temperature		T_{SI}			165	$^{\circ}C$
External creepage distance			4			mm
Internal creepage distance			4			mm
External clearance distance			4			mm
Insulation thickness			0.2			mm

Note

As per IEC 60747-5-2, §7.4.3.8.1, this optocoupler is suitable for “safe electrical insulation” only within the safety ratings. Compliance with the safety ratings shall be ensured by means of protective circuits.



VOD205T, VOD206T, VOD207T, VOD211T, VOD213T, VOD217T

Optocoupler, Phototransistor Output, Dual Channel, SOIC-8 Package
Vishay Semiconductors

TYPICAL CHARACTERISTICS

T_{amb} = 25 °C, unless otherwise specified

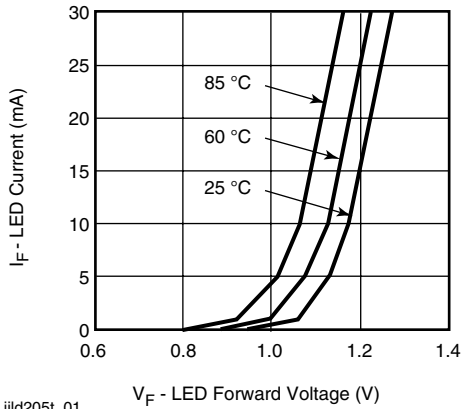

iiid205t_01

Fig. 4 - Forward Current vs. Forward Voltage

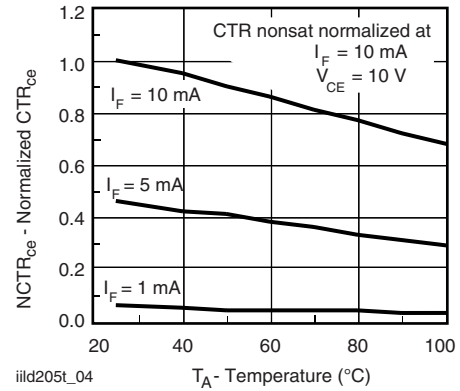

iiid205t_04

Fig. 7 - Current Transfer Ratio (normalized) vs. Ambient Temperature

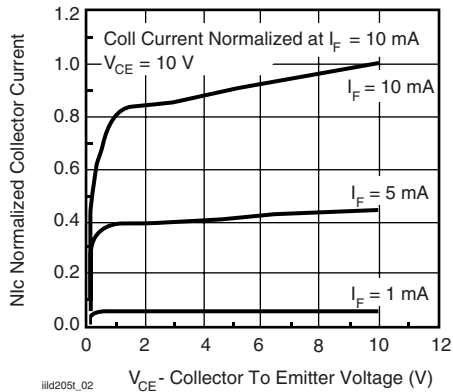

iiid205t_02

Fig. 5 - Collector Emitter Current vs. V_{CE}

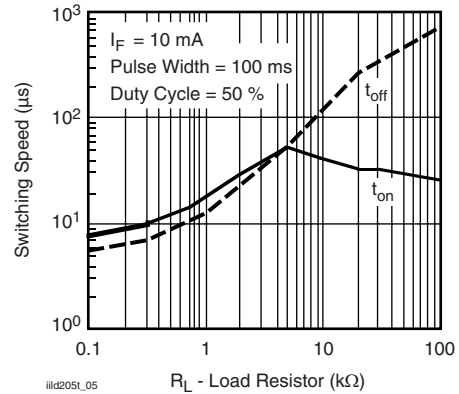

iiid205t_05

Fig. 8 - Switching Speed vs. Load Resistor

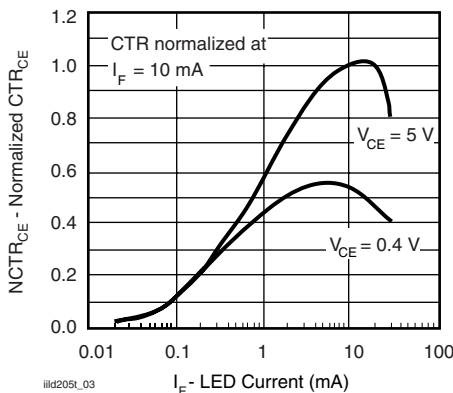

iiid205t_03

Fig. 6 - Normalized CTR_{CE} vs. Forward Current

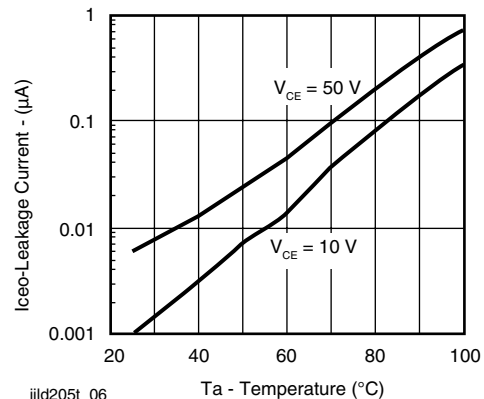

iiid205t_06

Fig. 9 - Collector Current vs. Ambient Temperature

VOD205T, VOD206T, VOD207T, VOD211T, VOD213T, VOD217T



Vishay Semiconductors

Optocoupler, Phototransistor
Output, Dual Channel,
SOIC-8 Package

PACKAGE DIMENSIONS in inches (millimeters)

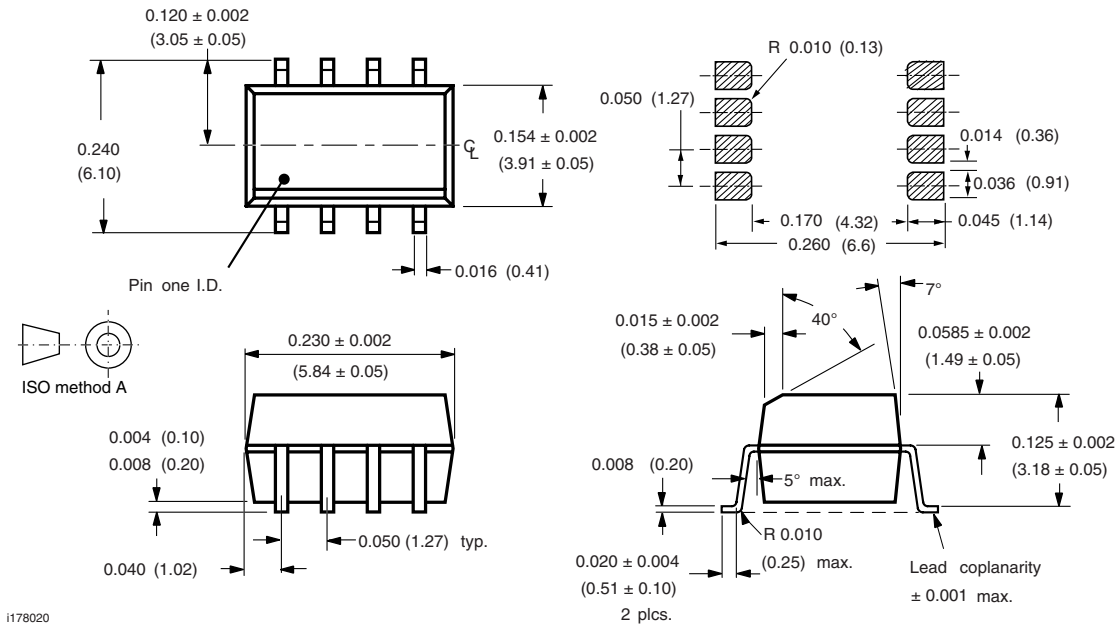

1178020



OZONE DEPLETING SUBSTANCES POLICY STATEMENT

It is the policy of Vishay Semiconductor GmbH to

1. Meet all present and future national and international statutory requirements.
2. Regularly and continuously improve the performance of our products, processes, distribution and operating systems with respect to their impact on the health and safety of our employees and the public, as well as their impact on the environment.

It is particular concern to control or eliminate releases of those substances into the atmosphere which are known as ozone depleting substances (ODSs).

The Montreal Protocol (1987) and its London Amendments (1990) intend to severely restrict the use of ODSs and forbid their use within the next ten years. Various national and international initiatives are pressing for an earlier ban on these substances.

Vishay Semiconductor GmbH has been able to use its policy of continuous improvements to eliminate the use of ODSs listed in the following documents.

1. Annex A, B and list of transitional substances of the Montreal Protocol and the London Amendments respectively.
2. Class I and II ozone depleting substances in the Clean Air Act Amendments of 1990 by the Environmental Protection Agency (EPA) in the USA
3. Council Decision 88/540/EEC and 91/690/EEC Annex A, B and C (transitional substances) respectively.

Vishay Semiconductor GmbH can certify that our semiconductors are not manufactured with ozone depleting substances and do not contain such substances.

We reserve the right to make changes to improve technical design and may do so without further notice.

Parameters can vary in different applications. All operating parameters must be validated for each customer application by the customer. Should the buyer use Vishay Semiconductors products for any unintended or unauthorized application, the buyer shall indemnify Vishay Semiconductors against all claims, costs, damages, and expenses, arising out of, directly or indirectly, any claim of personal damage, injury or death associated with such unintended or unauthorized use.

Vishay Semiconductor GmbH, P.O.B. 3535, D-74025 Heilbronn, Germany



Disclaimer

All product specifications and data are subject to change without notice.

Vishay Intertechnology, Inc., its affiliates, agents, and employees, and all persons acting on its or their behalf (collectively, "Vishay"), disclaim any and all liability for any errors, inaccuracies or incompleteness contained herein or in any other disclosure relating to any product.

Vishay disclaims any and all liability arising out of the use or application of any product described herein or of any information provided herein to the maximum extent permitted by law. The product specifications do not expand or otherwise modify Vishay's terms and conditions of purchase, including but not limited to the warranty expressed therein, which apply to these products.

No license, express or implied, by estoppel or otherwise, to any intellectual property rights is granted by this document or by any conduct of Vishay.

The products shown herein are not designed for use in medical, life-saving, or life-sustaining applications unless otherwise expressly indicated. Customers using or selling Vishay products not expressly indicated for use in such applications do so entirely at their own risk and agree to fully indemnify Vishay for any damages arising or resulting from such use or sale. Please contact authorized Vishay personnel to obtain written terms and conditions regarding products designed for such applications.

Product names and markings noted herein may be trademarks of their respective owners.