

Optocoupler, Photodarlington Output, High Gain, 300 V BV_{CEO}

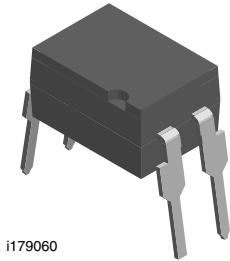

i179060

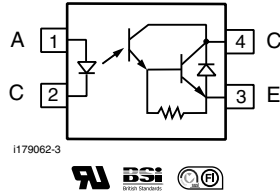

i179062-3

FEATURES

- High collector emitter voltage, $V_{CEO} = 300\text{ V}$
- High isolation test voltage: 5300 V_{RMS}
- Standard plastic DIP-4 package
- Compatible with Toshiba TLP627
- Compliant to RoHS Directive to 2002/95/EC and in accordance WEEE 2002/96/EC

**RoHS
COMPLIANT**
DESCRIPTION

The SFH619A is optically coupled isolators with a gallium arsenide infrared LED and a silicon photodarlington sensor. Switching can be achieved while maintaining a high degree of isolation between driving and load circuits. These optocouplers can be used to replace reed and mercury relays with advantages of long life, high speed switching and elimination of magnetic fields.

AGENCY APPROVALS

- UL - file no. E52744 system code H
- BSI IEC 60950; IEC 60065
- FIMKO

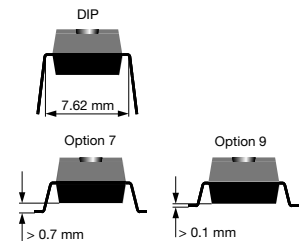
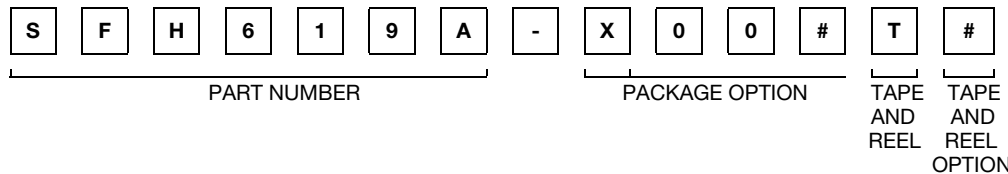
ORDERING INFORMATION

AGENCY CERTIFIED/PACKAGE	CTR (%)
UL, BSI, FIMKO	≥ 1000
DIP-4	SFH619A
SMD-4, option 7	SFH619A-X007T ⁽¹⁾
SMD-4, option 9	SFH619A-X009T ⁽¹⁾
	SFH619A-X009T0 ⁽²⁾

Note

- Additional options may be possible, please contact sales office.
- ⁽¹⁾ Also available in tubes; do not put T on the end.
- ⁽²⁾ Option with 90° rotation.

ABSOLUTE MAXIMUM RATINGS ($T_{amb} = 25\text{ °C}$, unless otherwise specified)

PARAMETER	TEST CONDITION	SYMBOL	VALUE	UNIT
INPUT				
Peak reverse voltage		V_{RM}	6	V
Forward continuous current		I_F	60	mA
Derate linearly from 25 °C			1.33	mW/°C
Power dissipation		P_{diss}	100	mW
OUTPUT				
Collector emitter breakdown voltage		BV_{CEO}	300	V
Emitter collector breakdown voltage		BV_{ECO}	0.3	V
Collector (load) current		I_C	125	mA
Derate linearly from 25 °C			2	mW/°C
Power dissipation		P_{diss}	150	mW

ABSOLUTE MAXIMUM RATINGS ($T_{amb} = 25\text{ }^{\circ}\text{C}$, unless otherwise specified)				
PARAMETER	TEST CONDITION	SYMBOL	VALUE	UNIT
COUPLER				
Derate linearly from 25 °C			3.33	mW/°C
Total power dissipation		P_{tot}	250	mW
Isolation test voltage between emitter and detector	$t = 1\text{ s}$	V_{ISO}	5300	V_{RMS}
Isolation resistance	$V_{IO} = 500\text{ V}, T_{amb} = 25\text{ }^{\circ}\text{C}$	R_{IO}	$\geq 10^{12}$	Ω
	$V_{IO} = 500\text{ V}, T_{amb} = 100\text{ }^{\circ}\text{C}$	R_{IO}	$\geq 10^{11}$	Ω
Storage temperature		T_{stg}	- 55 to + 150	°C
Operating temperature		T_{amb}	- 55 to + 100	°C
Soldering temperature (1)	max. 10 s, dip soldering: distance to seating plane $\geq 1.5\text{ mm}$	T_{sld}	260	°C

Notes

- Stresses in excess of the absolute maximum ratings can cause permanent damage to the device. Functional operation of the device is not implied at these or any other conditions in excess of those given in the operational sections of this document. Exposure to absolute maximum ratings for extended periods of the time can adversely affect reliability.

(1) Refer to reflow profile for soldering conditions for surface mounted devices (SMD). Refer to wave profile for soldering conditions for through hole devices (DIP).

ELECTRICAL CHARACTERISTICS ($T_{amb} = 25\text{ }^{\circ}\text{C}$, unless otherwise specified)						
PARAMETER	TEST CONDITION	SYMBOL	MIN.	TYP.	MAX.	UNIT
INPUT						
Forward voltage	$I_F = 10\text{ mA}$	V_F		1.2	1.5	V
Reverse current	$V_R = 6\text{ V}$	I_R		0.02	10	μA
Capacitance	$V_R = 0\text{ V}$	C_O		14		pF
OUTPUT						
Collector emitter breakdown voltage	$I_{CE} = 100\text{ }\mu\text{A}$	BV_{CEO}	300			V
Emitter collector breakdown voltage	$I_{EC} = 100\text{ }\mu\text{A}$	BV_{ECO}	0.3			V
Collector emitter dark current	$V_{CE} = 200\text{ V}, T_A = 25\text{ }^{\circ}\text{C}$	I_{CEO}		10	200	nA
	$V_{CE} = 200\text{ V}, T_A = 100\text{ }^{\circ}\text{C}$	I_{CEO}			20	nA
Collector emitter capacitance	$V_{CE} = 0\text{ V}, f = 1\text{ MHz}$	C_{CE}		39		pF
COUPLER						
Collector emitter saturation voltage	$I_F = 1\text{ mA}, I_C = 10\text{ mA}$	V_{CEsat}			1	V
	$I_F = 10\text{ mA}, I_C = 100\text{ mA}$	V_{CEsat}	0.3		1.2	V
Coupling capacitance	$V_{I-O} = 0\text{ V}, f = 1\text{ MHz}$	C_C		0.6		pF

Note

- Minimum and maximum values are testing requirements. Typical values are characteristics of the device and are the result of engineering evaluation. Typical values are for information only and are not part of the testing requirements.

CURRENT TRANSFER RATIO						
PARAMETER	TEST CONDITION	SYMBOL	MIN.	TYP.	MAX.	UNIT
Coupling transfer ratio	$I_F = 1\text{ mA}, V_{CE} = 1\text{ V}$	CTR	1000			%

SWITCHING CHARACTERISTICS						
PARAMETER	TEST CONDITION	SYMBOL	MIN.	TYP.	MAX.	UNIT
Rise time	$V_{CC} = 10\text{ V}, I_C = 10\text{ mA}, R_L = 100\text{ }\Omega$	t_r		3.5		μs
	$V_{CC} = 10\text{ V}, I_F = 16\text{ mA}, R_L = 180\text{ }\Omega$	t_r		1		μs
Fall time	$V_{CC} = 10\text{ V}, I_C = 10\text{ mA}, R_L = 100\text{ }\Omega$	t_f		14.5		μs
	$V_{CC} = 10\text{ V}, I_F = 16\text{ mA}, R_L = 180\text{ }\Omega$	t_f		20.5		μs
Turn-on time	$V_{CC} = 10\text{ V}, I_C = 10\text{ mA}, R_L = 100\text{ }\Omega$	t_{on}		4.5		μs
	$V_{CC} = 10\text{ V}, I_F = 16\text{ mA}, R_L = 180\text{ }\Omega$	t_{on}		1.5		μs
Turn-off time	$V_{CC} = 10\text{ V}, I_C = 10\text{ mA}, R_L = 100\text{ }\Omega$	t_{off}		29		μs
	$V_{CC} = 10\text{ V}, I_F = 16\text{ mA}, R_L = 180\text{ }\Omega$	t_{off}		53.5		μs

SAFETY AND INSULATION RATINGS						
PARAMETER	TEST CONDITION	SYMBOL	MIN.	TYP.	MAX.	UNIT
Climatic classification (according to IEC 68 part 1)				55/100/21		
Comparative tracking index		CTI	175		399	
V_{IOTM}			10000			V
V_{IORM}			890			V
P_{SO}					400	mW
I_{SI}					275	mA
T_{SI}					175	°C
Creepage distance	standard DIP-4		7			mm
Clearance distance	standard DIP-4		7			mm
Creepage distance	400 mil DIP-4		8			mm
Clearance distance	400 mil DIP-4		8			mm
Insulation thickness, reinforced rated	per IEC 60950 2.10.5.1		0.4			mm

Note

- As per IEC 60747-5-2, § 7.4.3.8.1, this optocoupler is suitable for "safe electrical insulation" only within the safety ratings. Compliance with the safety ratings shall be ensured by means of protective circuits.

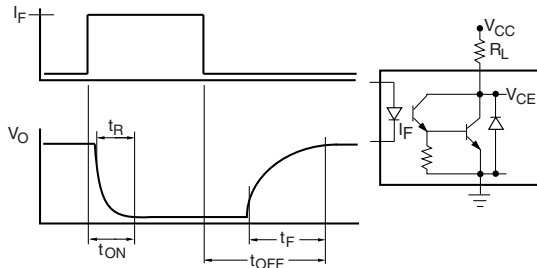
TYPICAL CHARACTERISTICS ($T_{amb} = 25\text{ °C}$, unless otherwise specified)

isfh619a_01

Fig. 1 - Switching Waveform and Switching Schematic

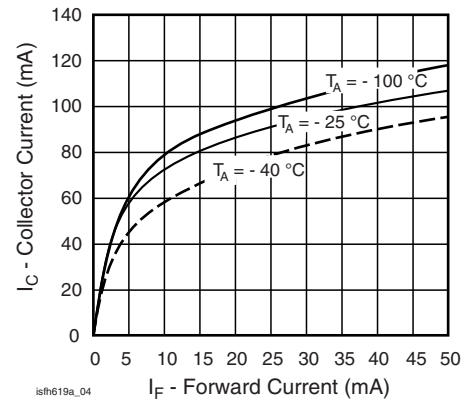

isfh619a_04

Fig. 3 - Collector Current vs. Forward Current

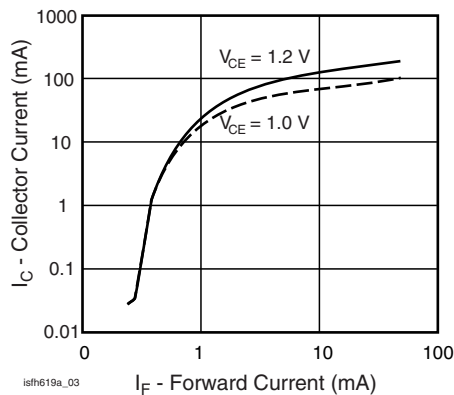

isfh619a_03

Fig. 2 - Collector Current (mA) vs. Forward Current (mA)

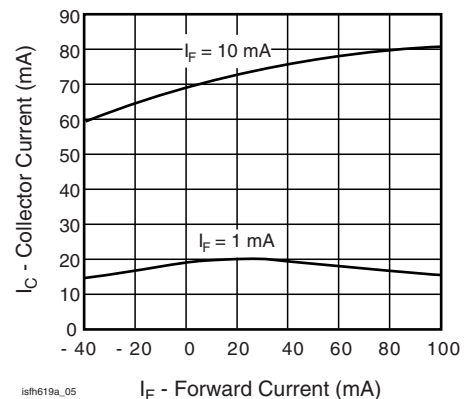

isfh619a_05

Fig. 4 - Collector Current vs. Ambient Temperature

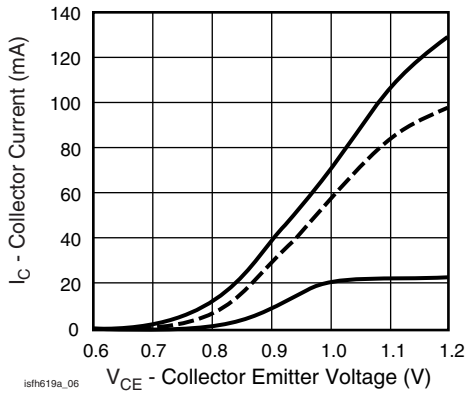

Fig. 5 - Collector Current vs. Collector Emitter Voltage

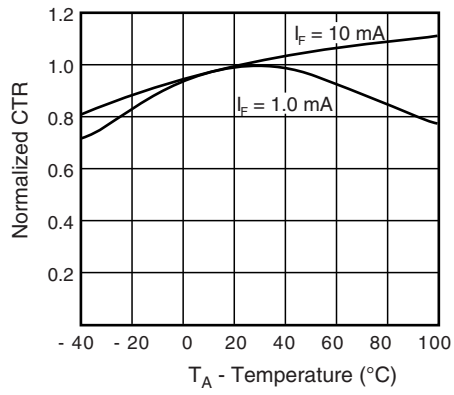

Fig. 8 - Normalized CTR vs. Temperature

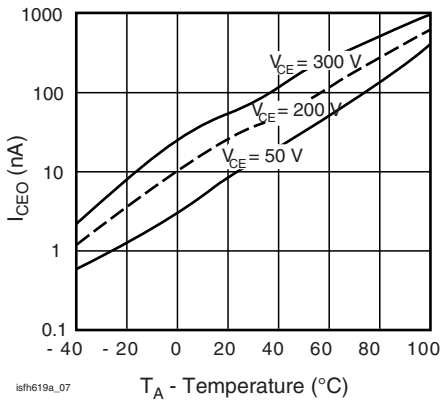

Fig. 6 - Collector Emitter Dark Current vs. Collector Emitter Voltage over Temperature

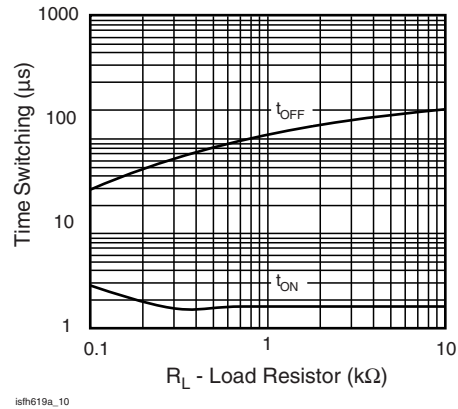

Fig. 9 - Switching Time vs. Load Resistor

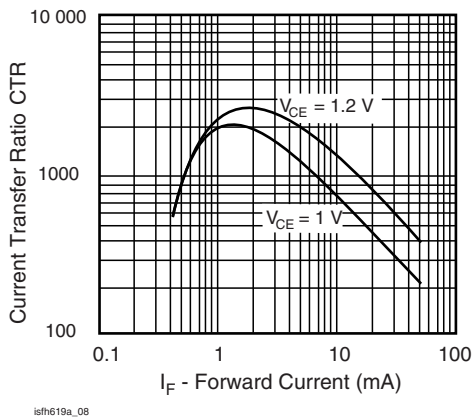
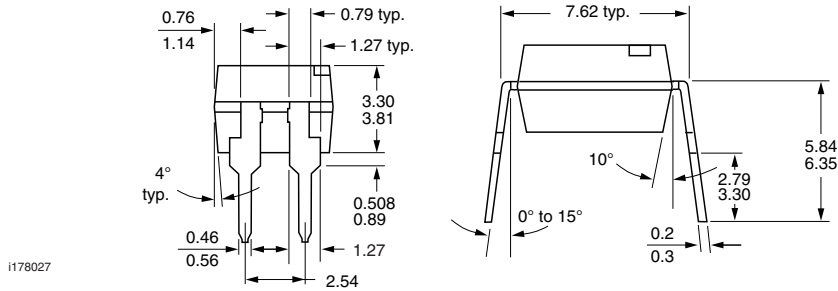
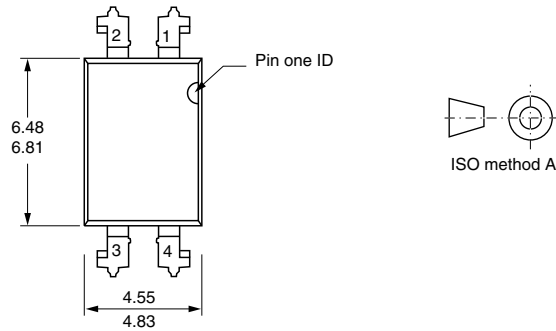
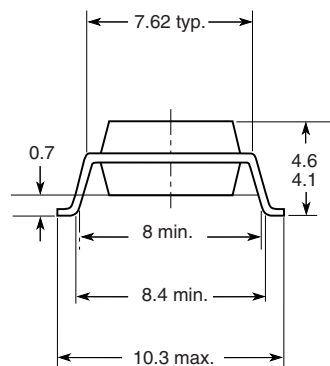
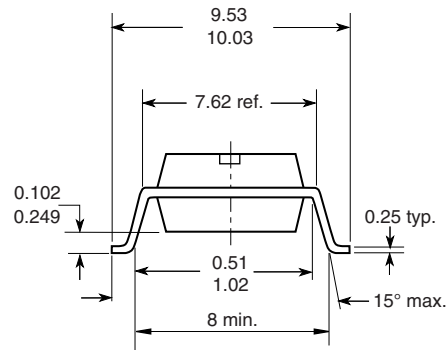

Fig. 7 - Current Transfer Ratio vs. Forward Current

PACKAGE DIMENSIONS in millimeters

i178027

Option 7

Option 9

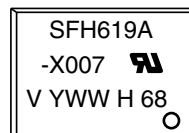
18494

PACKAGE MARKING (example)

21764-136

Notes

- Only option 7 reflected in the package marking.
- Tape and reel suffix (T) is not part of the package marking.



Disclaimer

ALL PRODUCT, PRODUCT SPECIFICATIONS AND DATA ARE SUBJECT TO CHANGE WITHOUT NOTICE TO IMPROVE RELIABILITY, FUNCTION OR DESIGN OR OTHERWISE.

Vishay Intertechnology, Inc., its affiliates, agents, and employees, and all persons acting on its or their behalf (collectively, "Vishay"), disclaim any and all liability for any errors, inaccuracies or incompleteness contained in any datasheet or in any other disclosure relating to any product.

Vishay makes no warranty, representation or guarantee regarding the suitability of the products for any particular purpose or the continuing production of any product. To the maximum extent permitted by applicable law, Vishay disclaims (i) any and all liability arising out of the application or use of any product, (ii) any and all liability, including without limitation special, consequential or incidental damages, and (iii) any and all implied warranties, including warranties of fitness for particular purpose, non-infringement and merchantability.

Statements regarding the suitability of products for certain types of applications are based on Vishay's knowledge of typical requirements that are often placed on Vishay products in generic applications. Such statements are not binding statements about the suitability of products for a particular application. It is the customer's responsibility to validate that a particular product with the properties described in the product specification is suitable for use in a particular application. Parameters provided in datasheets and/or specifications may vary in different applications and performance may vary over time. All operating parameters, including typical parameters, must be validated for each customer application by the customer's technical experts. Product specifications do not expand or otherwise modify Vishay's terms and conditions of purchase, including but not limited to the warranty expressed therein.

Except as expressly indicated in writing, Vishay products are not designed for use in medical, life-saving, or life-sustaining applications or for any other application in which the failure of the Vishay product could result in personal injury or death. Customers using or selling Vishay products not expressly indicated for use in such applications do so at their own risk and agree to fully indemnify and hold Vishay and its distributors harmless from and against any and all claims, liabilities, expenses and damages arising or resulting in connection with such use or sale, including attorneys fees, even if such claim alleges that Vishay or its distributor was negligent regarding the design or manufacture of the part. Please contact authorized Vishay personnel to obtain written terms and conditions regarding products designed for such applications.

No license, express or implied, by estoppel or otherwise, to any intellectual property rights is granted by this document or by any conduct of Vishay. Product names and markings noted herein may be trademarks of their respective owners.