

Optocoupler, Phototransistor Output, 300 V V_{CEO}

Features

- High Isolation Test Voltage, 5300 V_{RMS}
- High Collector-Emitter Voltage, $V_{CEO} = 300$ V
- Standard Plastic DIP-4 Package

Agency Approvals

- UL File #E52744 System Code H or J
- CSA 93751

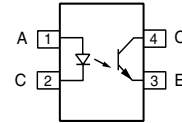
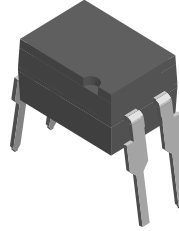

1179060

Description

The SFH614A features a high collector-emitter voltage and high isolation voltage. These couplers have a GaAs infrared emitting diode emitter, which is optically coupled to a silicon planar phototransistor detector, and is incorporated in a plastic DIP-4 package.

The coupling devices are designed for signal transmission between two electrically separated circuits.

Order Information

Part	Remarks
SFH614A	CTR > 50 %, DIP-4
SFH614A-X009	CTR > 50 %, SMD-4 (option 9)

For additional information on the available options refer to Option Information.

Absolute Maximum Ratings

$T_{amb} = 25$ °C, unless otherwise specified

Stresses in excess of the absolute Maximum Ratings can cause permanent damage to the device. Functional operation of the device is not implied at these or any other conditions in excess of those given in the operational sections of this document. Exposure to absolute Maximum Rating for extended periods of the time can adversely affect reliability.

Input

Parameter	Test condition	Symbol	Value	Unit
Reverse voltage		V_R	6.0	V
DC Forward current		I_F	60	mA
Surge forward current	$t \leq 10$ μ s	I_{FSM}	2.5	A
Derate linearly from 25 °C			1.33	mW/°C
Total power dissipation		P_{diss}	100	mW

Output

Parameter	Test condition	Symbol	Value	Unit
Collector-emitter voltage		V_{CEO}	300	V
Emitter-collector voltage		V_{ECO}	7.0	V
Collector current		I_C	50	mA
	$t \leq 1.0$ ms	I_C	100	mA
Derate linearly from 25 °C			2.00	mW/°C
Total power dissipation		P_{diss}	150	mW

Coupler

Parameter	Test condition	Symbol	Value	Unit
Derate linearly from 25 °C			3.33	mW/°C
Total power dissipation		P_{tot}	250	mW
Isolation test voltage between input and output, climate acc. to IEC 60068-1 : 1988 (T = 1.0 s)		V_{ISO}	5300	V_{RMS}
Creepage distance			≥ 7.0	mm
Clearance			≥ 7.0	mm
Insulation thickness between emitter and detector			≥ 0.4	mm
Comparative tracking index acc. to DIN IEC 112/VDE 0303, part 1 : 06-84			≥ 175	
Isolation resistance	$V_{IO} = 500\text{ V}, T_{amb} = 25\text{ °C}$	R_{IO}	≥ 10^{12}	Ω
	$V_{IO} = 500\text{ V}, T_{amb} = 100\text{ °C}$	R_{IO}	≥ 10^{11}	Ω
Storage temperature range		T_{stg}	- 55 to +150	°C
Ambient temperature range		T_{amb}	- 55 to +100	°C
Junction temperature		T_j	100	°C
Soldering temperature	max. 10 s, dip soldering: distance to seating plane ≥ 1.5 mm	T_{sld}	260	°C

Electrical Characteristics

$T_{amb} = 25\text{ °C}$, unless otherwise specified

Minimum and maximum values are testing requirements. Typical values are characteristics of the device and are the result of engineering evaluation. Typical values are for information only and are not part of the testing requirements.

Input

Parameter	Test condition	Symbol	Min	Typ.	Max	Unit
Forward voltage	$I_F = 10\text{ mA}$	V_F		1.15	1.5	V
Reverse current	$V_R = 6.0\text{ V}$	I_R		0.02	10	μA
Capacitance	$V_R = 0\text{ V}, f = 1.0\text{ MHz}$	C_O		14		pF

Output

Parameter	Test condition	Symbol	Min	Typ.	Max	Unit
Collector-emitter breakdown voltage	$I_{CE} = 100\text{ μA}$	BV_{CEO}	300			V
Emitter-collector breakdown voltage	$I_{EC} = 10\text{ μA}$	BV_{ECO}	7.0			V
Collector-emitter dark current	$V_{CE} = 10\text{ V}$	I_{CEO}		15	1.0	μA
Collector-emitter capacitance	$V_{CE} = 10\text{ V}, f = 1.0\text{ MHz}$	C_{CE}		8.0		pF

Coupler

Parameter	Test condition	Symbol	Min	Typ.	Max	Unit
Collector-emitter saturation voltage	$I_F = 20\text{ mA}, I_C = 1.0\text{ mA}$	V_{CEsat}			0.3	V
Coupling capacitance	$V_{I-O} = 0\text{ V}, f = 1.0\text{ MHz}$	C_C			0.5	V

Current Transfer Ratio

Parameter	Test condition	Symbol	Min	Typ.	Max	Unit
Current Transfer Ratio	$I_F = 10 \text{ mA}$, $V_{CE} = 10 \text{ V}$	CTR	50			%

Switching Characteristics

Parameter	Test condition	Symbol	Min	Typ.	Max	Unit
Turn on time	$V_{CE} = 2.0 \text{ V}$, $I_C = 2.0 \text{ mA}$, $R_L = 100 \Omega$	t_{on}		6.0		μs
Turn off time	$V_{CE} = 2.0 \text{ V}$, $I_C = 2.0 \text{ mA}$, $R_L = 100 \Omega$	t_{off}		6		μs
Rise time	$V_{CE} = 2.0 \text{ V}$, $I_C = 2.0 \text{ mA}$, $R_L = 100 \Omega$	t_r		3.0	10	μs
Fall time	$V_{CE} = 2.0 \text{ V}$, $I_C = 2.0 \text{ mA}$, $R_L = 100 \Omega$	t_f		5.0	12	μs

Typical Characteristics ($T_{amb} = 25^\circ\text{C}$ unless otherwise specified)

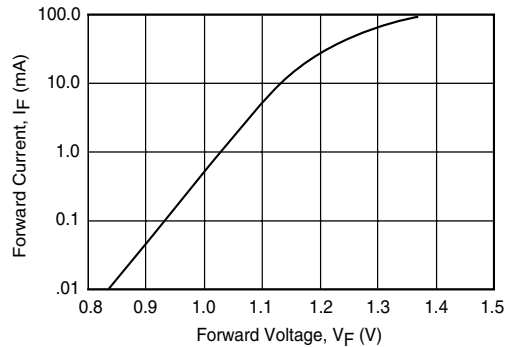

isfh614a_01

Fig. 1 Forward Current vs. Forward Voltage

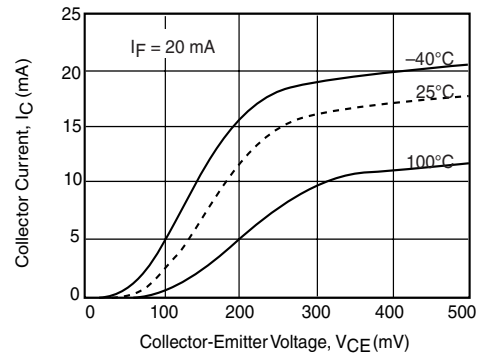

isfh614a_03

Fig. 3 Collector Current vs. Collector Emitter Voltage

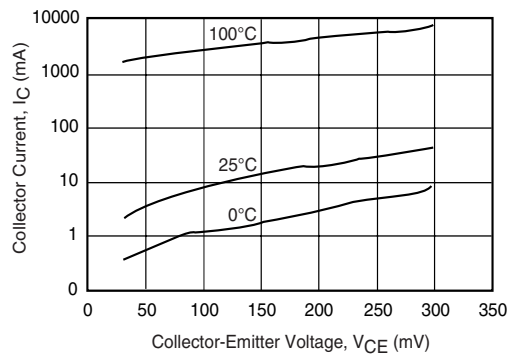

isfh614a_02

Fig. 2 Collector-Emitter Dark Current vs. Collector-Emitter Voltage

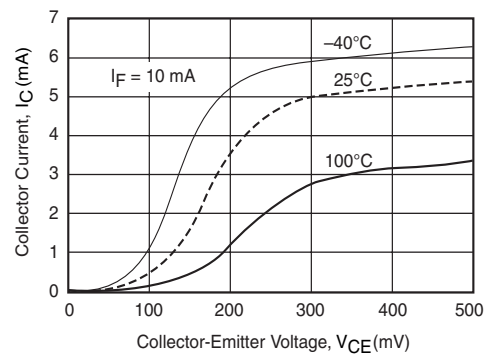

isfh614a_04

Fig. 4 Collector Current vs. Collector Emitter Voltage

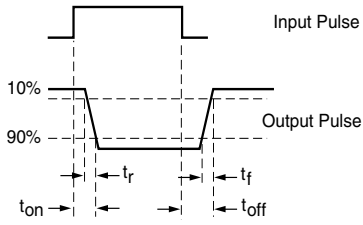

isf614a_06

Fig. 5 Switching Waveform

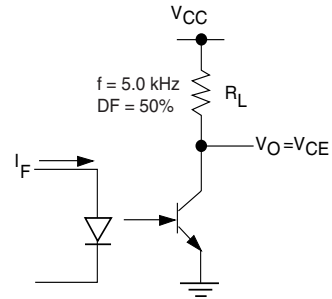

isf614a_07

Fig. 6 Switching Schematic

Package Dimensions in Inches (mm)

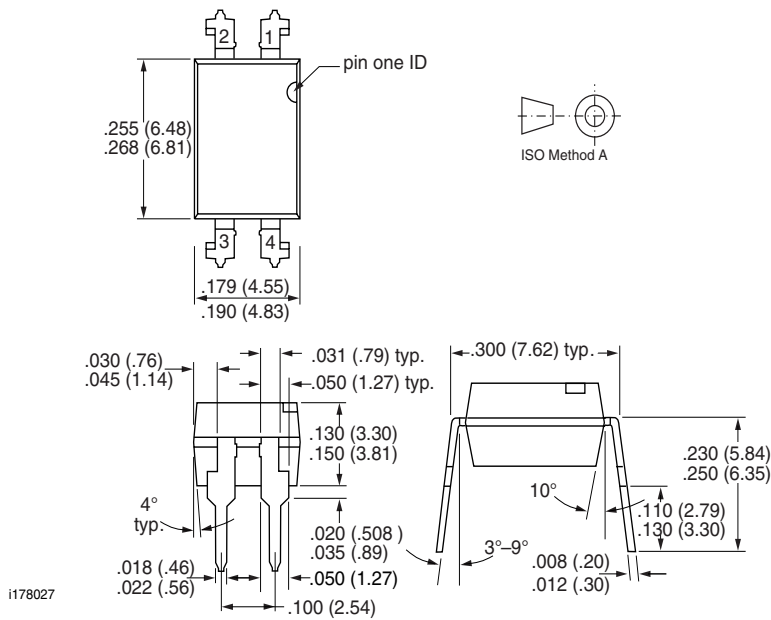

i178027

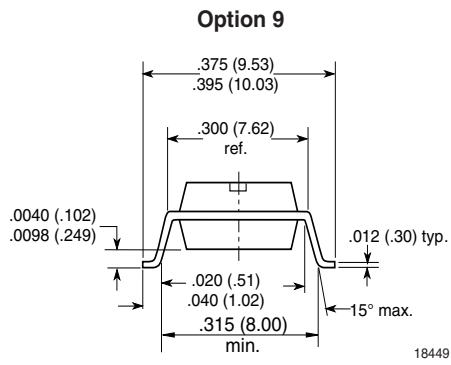

Ozone Depleting Substances Policy Statement

It is the policy of **Vishay Semiconductor GmbH** to

1. Meet all present and future national and international statutory requirements.
2. Regularly and continuously improve the performance of our products, processes, distribution and operating systems with respect to their impact on the health and safety of our employees and the public, as well as their impact on the environment.

It is particular concern to control or eliminate releases of those substances into the atmosphere which are known as ozone depleting substances (ODSs).

The Montreal Protocol (1987) and its London Amendments (1990) intend to severely restrict the use of ODSs and forbid their use within the next ten years. Various national and international initiatives are pressing for an earlier ban on these substances.

Vishay Semiconductor GmbH has been able to use its policy of continuous improvements to eliminate the use of ODSs listed in the following documents.

1. Annex A, B and list of transitional substances of the Montreal Protocol and the London Amendments respectively
2. Class I and II ozone depleting substances in the Clean Air Act Amendments of 1990 by the Environmental Protection Agency (EPA) in the USA
3. Council Decision 88/540/EEC and 91/690/EEC Annex A, B and C (transitional substances) respectively.

Vishay Semiconductor GmbH can certify that our semiconductors are not manufactured with ozone depleting substances and do not contain such substances.

**We reserve the right to make changes to improve technical design
and may do so without further notice.**

Parameters can vary in different applications. All operating parameters must be validated for each customer application by the customer. Should the buyer use Vishay Semiconductors products for any unintended or unauthorized application, the buyer shall indemnify Vishay Semiconductors against all claims, costs, damages, and expenses, arising out of, directly or indirectly, any claim of personal damage, injury or death associated with such unintended or unauthorized use.

Vishay Semiconductor GmbH, P.O.B. 3535, D-74025 Heilbronn, Germany
Telephone: 49 (0)7131 67 2831, Fax number: 49 (0)7131 67 2423

This datasheet has been download from:

www.datasheetcatalog.com

Datasheets for electronics components.