

High Efficiency LED in \varnothing 5 mm Tinted Diffused Package

Description

The TLH.54.. series was developed for standard applications like general indicating and lighting purposes.

It is housed in a 5 mm tinted diffused plastic package. The wide viewing angle of these devices provides a high on-off contrast.

Several selection types with different luminous intensities are offered. All LEDs are categorized in luminous intensity groups. The green and yellow LEDs are categorized additionally in wavelength groups.

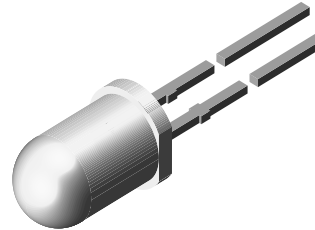

19223



That allows users to assemble LEDs with uniform appearance.

Features

- Choice of three bright colors
- Standard T-1 $\frac{3}{4}$ package
- Small mechanical tolerances
- Suitable for DC and high peak current
- Wide viewing angle
- Luminous intensity categorized
- Yellow and green color categorized
- TLH.54.. with stand-offs
- Lead-free device

Applications

- Status lights
- OFF / ON indicator
- Background illumination
- Readout lights
- Maintenance lights
- Legend light

Parts Table

| Part | Color, Luminous Intensity | Angle of Half Intensity ($\pm\phi$) | Technology |
|----------|--------------------------------|---------------------------------------|--------------|
| TLHR5400 | Red, $I_V = 3.5$ mcd (typ.) | 30 ° | GaAsP on GaP |
| TLHR5401 | Red, $I_V = 7$ mcd (typ.) | 30 ° | GaAsP on GaP |
| TLHR5405 | Red, $I_V = 10$ mcd (typ.) | 30 ° | GaAsP on GaP |
| TLHY5400 | Yellow, $I_V = 3.5$ mcd (typ.) | 30 ° | GaAsP on GaP |
| TLHY5401 | Yellow, $I_V = 7$ mcd (typ.) | 30 ° | GaAsP on GaP |
| TLHY5405 | Yellow, $I_V = 10$ mcd (typ.) | 30 ° | GaAsP on GaP |
| TLHG5400 | Green, $I_V = 4$ mcd (typ.) | 30 ° | GaP on GaP |
| TLHG5401 | Green, $I_V = 7$ mcd (typ.) | 30 ° | GaP on GaP |
| TLHG5405 | Green, $I_V = 15$ mcd (typ.) | 30 ° | GaP on GaP |

Absolute Maximum Ratings

$T_{amb} = 25\text{ }^{\circ}\text{C}$, unless otherwise specified
 TLHR54.., TLHY54.., TLHG54.., TLHG54..,

| Parameter | Test condition | Symbol | Value | Unit |
|-----------------------------------------|-------------------------------------------|------------|---------------|--------------------|
| Reverse voltage | | V_R | 6 | V |
| DC Forward current | $T_{amb} \leq 65\text{ }^{\circ}\text{C}$ | I_F | 30 | mA |
| Surge forward current | $t_p \leq 10\text{ }\mu\text{s}$ | I_{FSM} | 1 | A |
| Power dissipation | $T_{amb} \leq 65\text{ }^{\circ}\text{C}$ | P_V | 100 | mW |
| Junction temperature | | T_j | 100 | $^{\circ}\text{C}$ |
| Operating temperature range | | T_{amb} | - 20 to + 100 | $^{\circ}\text{C}$ |
| Storage temperature range | | T_{stg} | - 55 to + 100 | $^{\circ}\text{C}$ |
| Soldering temperature | $t \leq 5\text{ s}$, 2 mm from body | T_{sd} | 260 | $^{\circ}\text{C}$ |
| Thermal resistance junction/ ambient | | R_{thJA} | 350 | K/W |

Optical and Electrical Characteristics

$T_{amb} = 25\text{ }^{\circ}\text{C}$, unless otherwise specified

Red

TLHR54..

| Parameter | Test condition | Part | Symbol | Min | Typ. | Max | Unit |
|----------------------------------|--------------------------------|----------|-------------|-----|----------|-----|------|
| Luminous intensity ¹⁾ | $I_F = 10\text{ mA}$ | TLHR5400 | I_V | 1.6 | 3.5 | | mcd |
| | | TLHR5401 | I_V | 4 | 7 | | mcd |
| | | TLHR5405 | I_V | 6.3 | 10 | | mcd |
| Dominant wavelength | $I_F = 10\text{ mA}$ | | λ_d | 612 | | 625 | nm |
| Peak wavelength | $I_F = 10\text{ mA}$ | | λ_p | | 635 | | nm |
| Angle of half intensity | $I_F = 10\text{ mA}$ | | ϕ | | ± 30 | | deg |
| Forward voltage | $I_F = 20\text{ mA}$ | | V_F | | 2 | 3 | V |
| Reverse voltage | $I_R = 10\text{ }\mu\text{A}$ | | V_R | 6 | 15 | | V |
| Junction capacitance | $V_R = 0$, $f = 1\text{ MHz}$ | | C_j | | 50 | | pF |

¹⁾ in one Packing Unit $I_{Vmin}/I_{Vmax} \leq 0.5$

Yellow

TLHY54..

| Parameter | Test condition | Part | Symbol | Min | Typ. | Max | Unit |
|----------------------------------|--------------------------------|----------|-------------|-----|----------|-----|------|
| Luminous intensity ¹⁾ | $I_F = 10\text{ mA}$ | TLHY5400 | I_V | 1.6 | 3.5 | | mcd |
| | | TLHY5401 | I_V | 4 | 7 | | mcd |
| | | TLHY5401 | I_V | 6.3 | 10 | | mcd |
| Dominant wavelength | $I_F = 10\text{ mA}$ | | λ_d | 581 | | 594 | nm |
| Peak wavelength | $I_F = 10\text{ mA}$ | | λ_p | | 585 | | nm |
| Angle of half intensity | $I_F = 10\text{ mA}$ | | ϕ | | ± 30 | | deg |
| Forward voltage | $I_F = 20\text{ mA}$ | | V_F | | 2.4 | 3 | V |
| Reverse voltage | $I_R = 10\text{ }\mu\text{A}$ | | V_R | 6 | 15 | | V |
| Junction capacitance | $V_R = 0$, $f = 1\text{ MHz}$ | | C_j | | 50 | | pF |

¹⁾ in one Packing Unit $I_{Vmin}/I_{Vmax} \leq 0.5$

Green

TLHG54..

| Parameter | Test condition | Part | Symbol | Min | Typ. | Max | Unit |
|----------------------------------|------------------------------|----------|-------------|-----|----------|-----|------|
| Luminous intensity ¹⁾ | $I_F = 10 \text{ mA}$ | TLHG5400 | I_V | 1.6 | 4 | | mcd |
| | | TLHG5401 | I_V | 4 | 7 | | mcd |
| | | TLHG5405 | I_V | 6.3 | 15 | | mcd |
| Dominant wavelength | $I_F = 10 \text{ mA}$ | | λ_d | 562 | | 575 | nm |
| Peak wavelength | $I_F = 10 \text{ mA}$ | | λ_p | | 565 | | nm |
| Angle of half intensity | $I_F = 10 \text{ mA}$ | | φ | | ± 30 | | deg |
| Forward voltage | $I_F = 20 \text{ mA}$ | | V_F | | 2.4 | 3 | V |
| Reverse voltage | $I_R = 10 \mu\text{A}$ | | V_R | 6 | 15 | | V |
| Junction capacitance | $V_R = 0, f = 1 \text{ MHz}$ | | C_j | | 50 | | pF |

¹⁾ in one Packing Unit $I_{Vmin}/I_{Vmax} \leq 0.5$

Typical Characteristics ($T_{amb} = 25^\circ\text{C}$ unless otherwise specified)

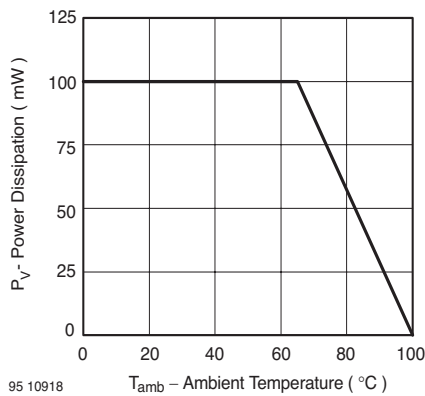

Figure 1. Power Dissipation vs. Ambient Temperature

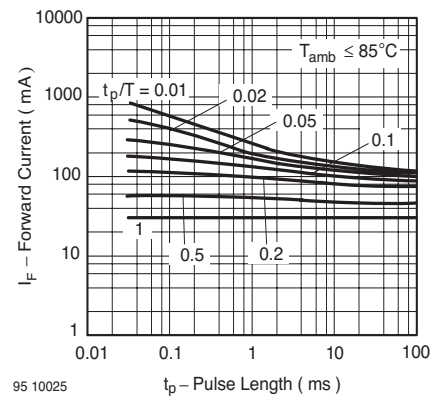

Figure 3. Forward Current vs. Pulse Length

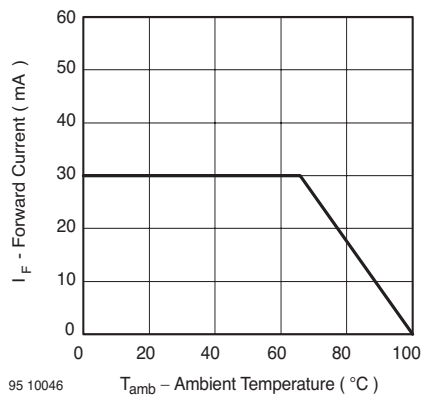

Figure 2. Forward Current vs. Ambient Temperature

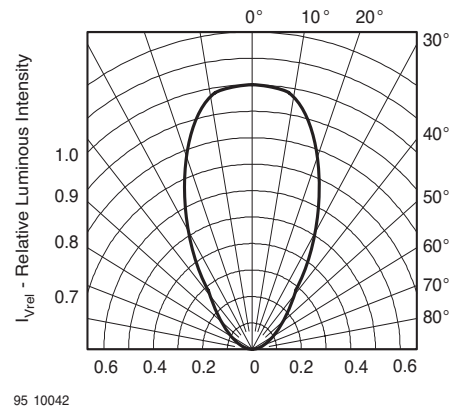

Figure 4. Rel. Luminous Intensity vs. Angular Displacement

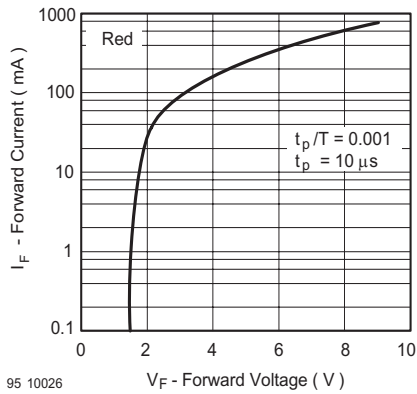

Figure 5. Forward Current vs. Forward Voltage

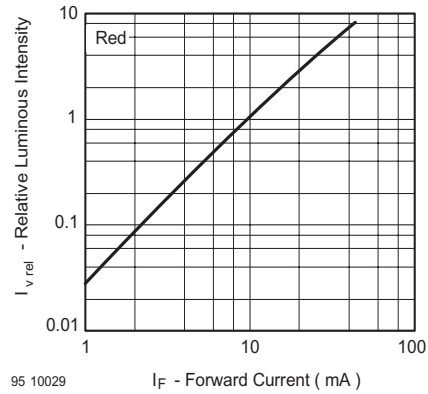

Figure 8. Relative Luminous Intensity vs. Forward Current

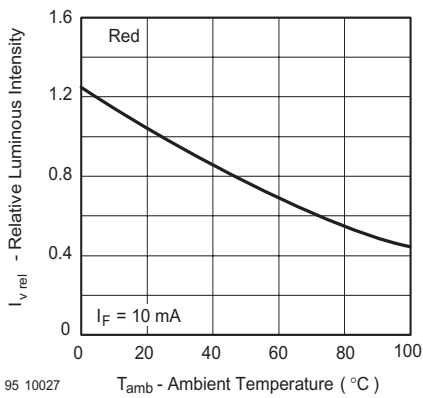

Figure 6. Rel. Luminous Intensity vs. Ambient Temperature

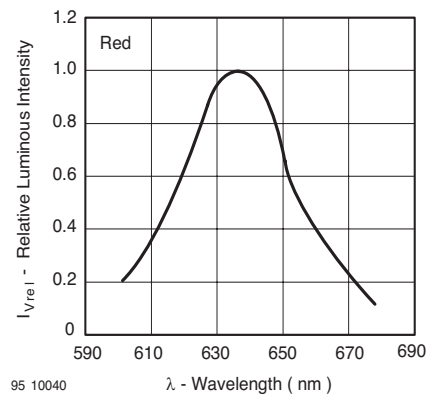

Figure 9. Relative Intensity vs. Wavelength

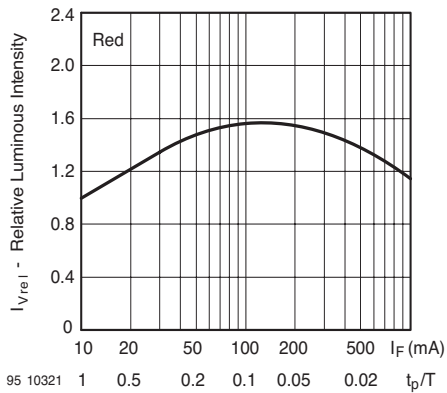

Figure 7. Rel. Lumin. Intensity vs. Forw. Current/Duty Cycle

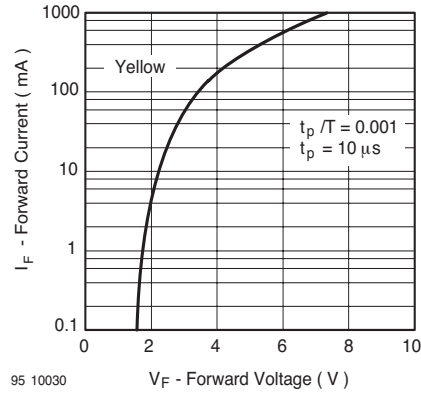

Figure 10. Forward Current vs. Forward Voltage

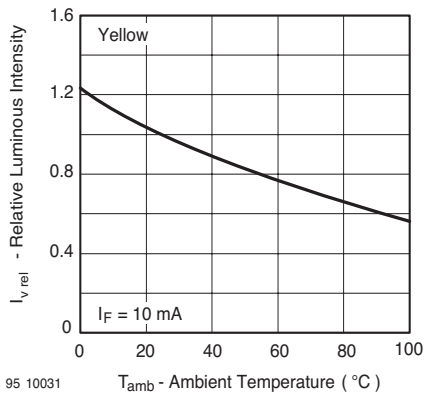

Figure 11. Rel. Luminous Intensity vs. Ambient Temperature

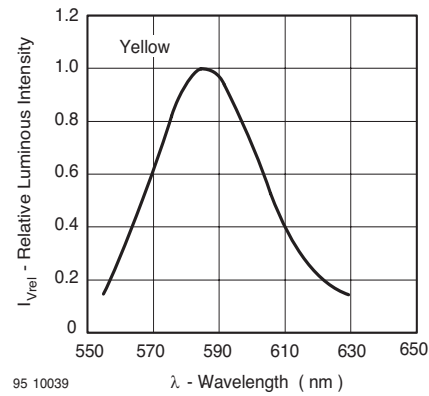

Figure 14. Relative Intensity vs. Wavelength

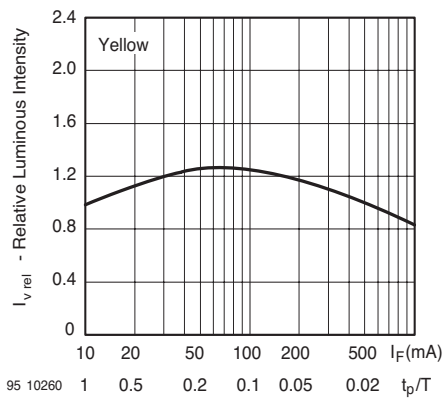

Figure 12. Rel. Lumin. Intensity vs. Forw. Current/Duty Cycle

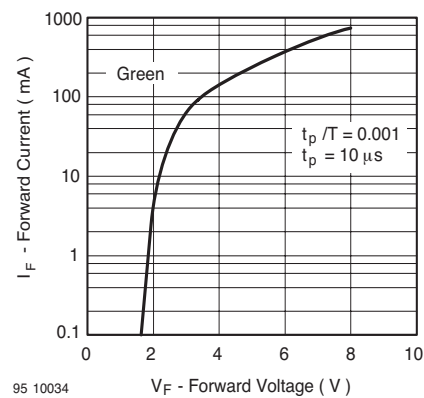

Figure 15. Forward Current vs. Forward Voltage

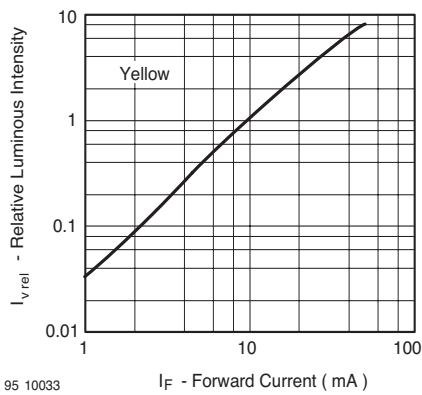

Figure 13. Relative Luminous Intensity vs. Forward Current

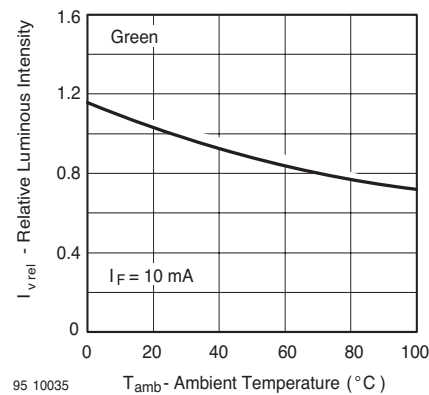

Figure 16. Rel. Luminous Intensity vs. Ambient Temperature

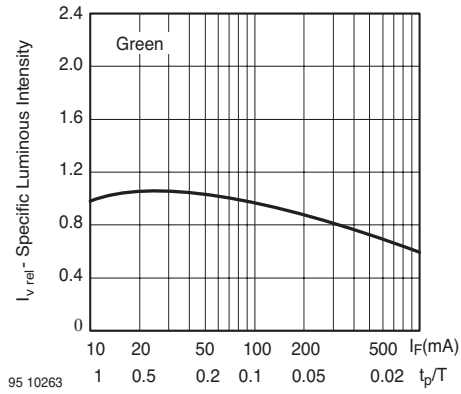

Figure 17. Specific Luminous Intensity vs. Forward Current

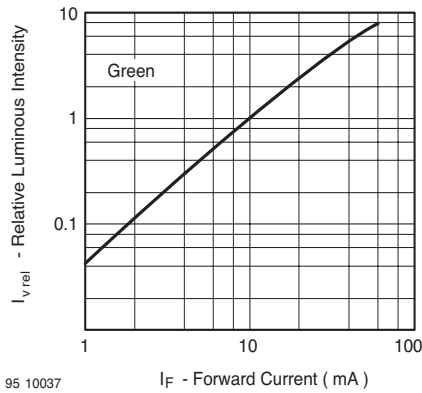

Figure 18. Relative Luminous Intensity vs. Forward Current

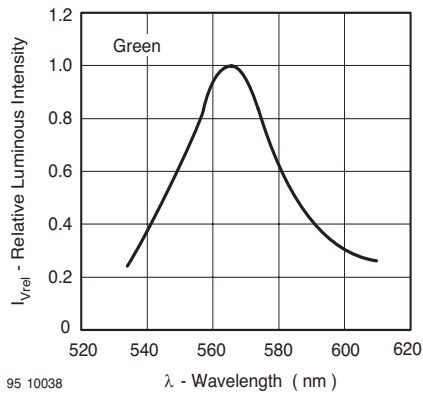
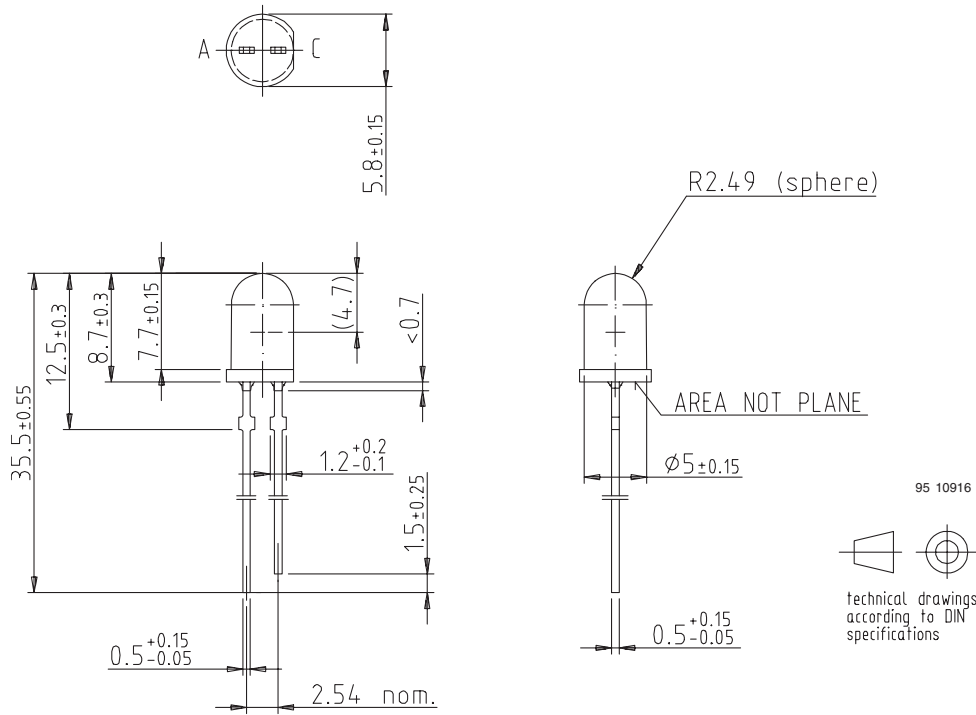

Figure 19. Relative Intensity vs. Wavelength

Package Dimensions in mm



Ozone Depleting Substances Policy Statement

It is the policy of **Vishay Semiconductor GmbH** to

1. Meet all present and future national and international statutory requirements.
2. Regularly and continuously improve the performance of our products, processes, distribution and operating systems with respect to their impact on the health and safety of our employees and the public, as well as their impact on the environment.

It is particular concern to control or eliminate releases of those substances into the atmosphere which are known as ozone depleting substances (ODSs).

The Montreal Protocol (1987) and its London Amendments (1990) intend to severely restrict the use of ODSs and forbid their use within the next ten years. Various national and international initiatives are pressing for an earlier ban on these substances.

Vishay Semiconductor GmbH has been able to use its policy of continuous improvements to eliminate the use of ODSs listed in the following documents.

1. Annex A, B and list of transitional substances of the Montreal Protocol and the London Amendments respectively
2. Class I and II ozone depleting substances in the Clean Air Act Amendments of 1990 by the Environmental Protection Agency (EPA) in the USA
3. Council Decision 88/540/EEC and 91/690/EEC Annex A, B and C (transitional substances) respectively.

Vishay Semiconductor GmbH can certify that our semiconductors are not manufactured with ozone depleting substances and do not contain such substances.

**We reserve the right to make changes to improve technical design
and may do so without further notice.**

Parameters can vary in different applications. All operating parameters must be validated for each customer application by the customer. Should the buyer use Vishay Semiconductors products for any unintended or unauthorized application, the buyer shall indemnify Vishay Semiconductors against all claims, costs, damages, and expenses, arising out of, directly or indirectly, any claim of personal damage, injury or death associated with such unintended or unauthorized use.

Vishay Semiconductor GmbH, P.O.B. 3535, D-74025 Heilbronn, Germany
Telephone: 49 (0)7131 67 2831, Fax number: 49 (0)7131 67 2423



Notice

Specifications of the products displayed herein are subject to change without notice. Vishay Intertechnology, Inc., or anyone on its behalf, assumes no responsibility or liability for any errors or inaccuracies.

Information contained herein is intended to provide a product description only. No license, express or implied, by estoppel or otherwise, to any intellectual property rights is granted by this document. Except as provided in Vishay's terms and conditions of sale for such products, Vishay assumes no liability whatsoever, and disclaims any express or implied warranty, relating to sale and/or use of Vishay products including liability or warranties relating to fitness for a particular purpose, merchantability, or infringement of any patent, copyright, or other intellectual property right.

The products shown herein are not designed for use in medical, life-saving, or life-sustaining applications. Customers using or selling these products for use in such applications do so at their own risk and agree to fully indemnify Vishay for any damages resulting from such improper use or sale.