

Red PLCC4 Surface Mount LED

OVSASBC2R8

- High intensity with low power consumption
- White PLCC4 packaged in 8 mm tape on 7" diameter reel
- Compatible with automatic placement equipment
- Dimensions: 3.5 x 2.8 x 1.95 mm
- 120° viewing angle



The **OVSASBC2R8** is designed for wide angle, uniform light output. Its internal reflector and colorless clear lens optimize luminous intensity and make it ideal for backlighting applications and for coupling with light guides.

Applications

- Traffic lights
- Signal and symbol luminaire
- Mono-color indicators
- Backlighting (LCD, switches, displays and illuminated advertising)
- Interior automotive lighting (instrumentation clusters)
- Safety marker lights (steps, exit ways)

Part Number	Material	Emitted Color	Intensity Typ. mcd	Lens Color
OVSASBC2R8	AlInGaP	Red	900	Water Clear

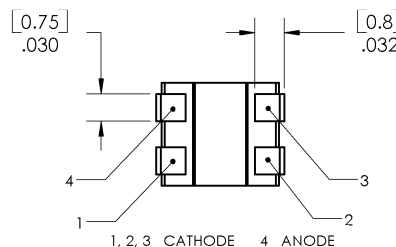
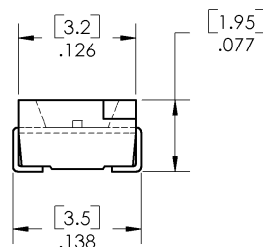
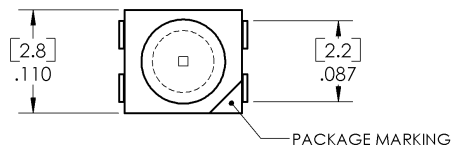

DIMENSIONS ARE IN INCHES AND [MILLIMETERS].

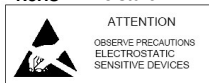

DO NOT LOOK DIRECTLY AT RED WITH UNSHIELDED EYES OR DAMAGE TO RETINA MAY OCCUR.

OPTEK reserves the right to make changes at any time in order to improve design and to supply the best product possible.

Red PLCC4 Surface Mount LED

OVSASBC2R8

Absolute Maximum Ratings

$T_A = 25^\circ\text{C}$ unless otherwise noted

Storage Temperature Range	-40 ~ +100°C
Operating Temperature Range	-40 ~ +100°C
Junction Temperature	110°C
Reverse Voltage	5 V
Continuous Forward Current	70 mA
Peak Forward Current (10% Duty Cycle, PW ≤ 100 μsec)	200 mA
Power Dissipation	225 mW

Electrical Characteristics

$T_A = 25^\circ\text{C}$ unless otherwise noted

SYMBOL	PARAMETER	MIN	TYP	MAX	UNITS	CONDITIONS
I_V	Luminous Intensity	560	900	----	mcd	$I_F = 50\text{ mA}$
V_F	Forward Voltage	----	2.5	3.2	V	$I_F = 50\text{ mA}$
I_R	Reverse Current	----	----	10	μA	$V_R = 5\text{ V}$
λ_D	Dominant Wavelength	620	628	635	nm	$I_F = 50\text{ mA}$
$2\theta_{1/2}$	50% Power Angle	----	120	----	deg	$I_F = 50\text{ mA}$

Standard Bins ($I_F = 50\text{ mA}$)

Lamps are sorted to luminous intensity (I_V) and dominant wavelength (λ_D) bins shown. Orders for OVSASBC2R8 may be filled with any or all bins contained as below.

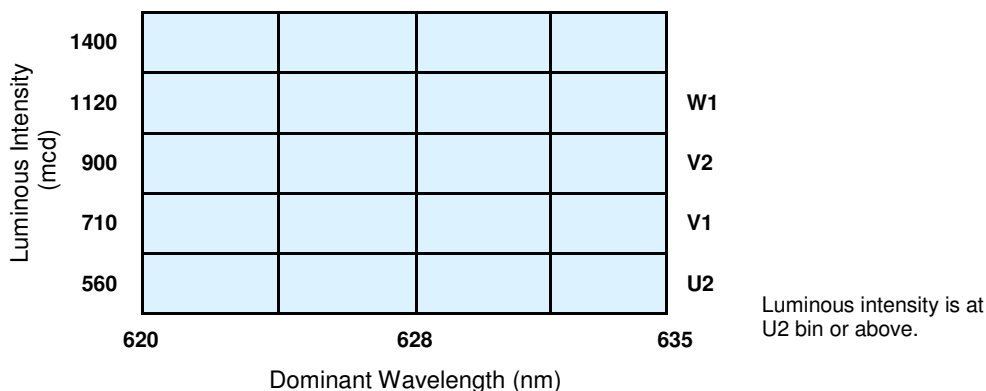

Notes:

1. All ranks will be included per delivery, rank ratio will be based on the chip distribution.
2. To designate luminous intensity ranks, please contact OPTEK.

OPTEK reserves the right to make changes at any time in order to improve design and to supply the best product possible.

Typical Electro-Optical Characteristics Curves

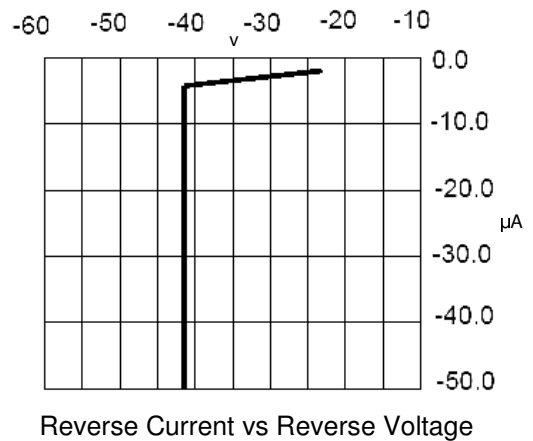
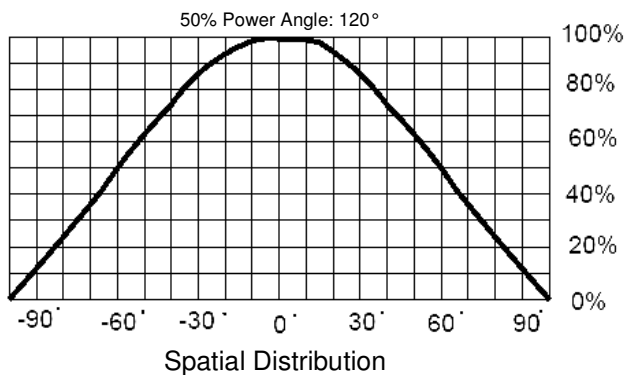
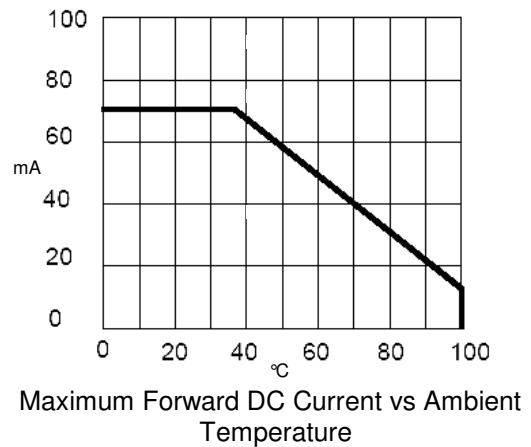
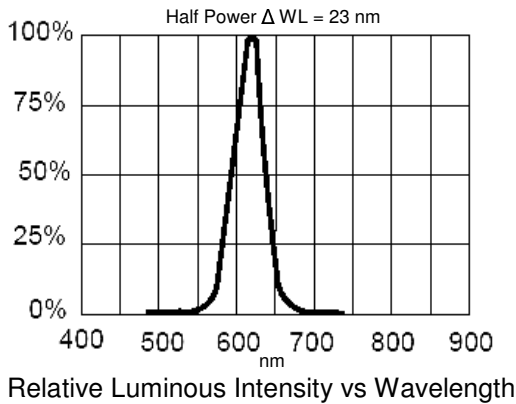
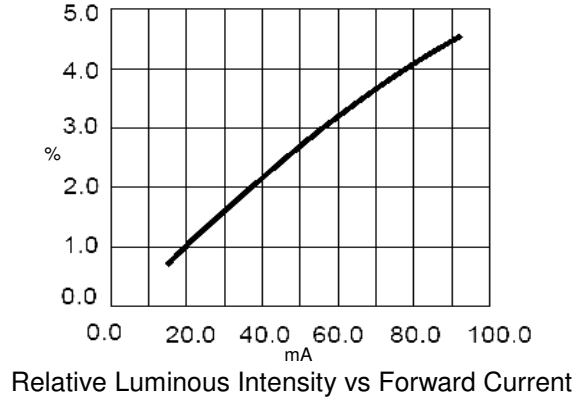
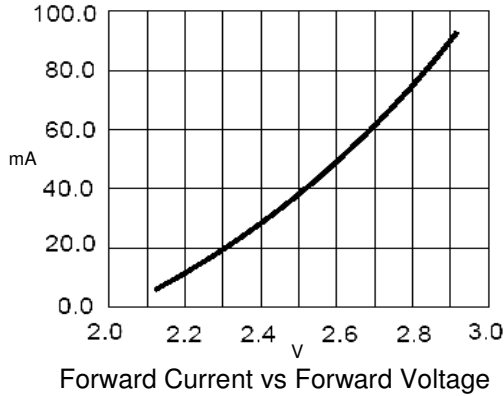

OPTEK reserves the right to make changes at any time in order to improve design and to supply the best product possible.

Red PLCC4 Surface Mount LED

OVSASBC2R8

Reel Dimensions: 7-inch reel

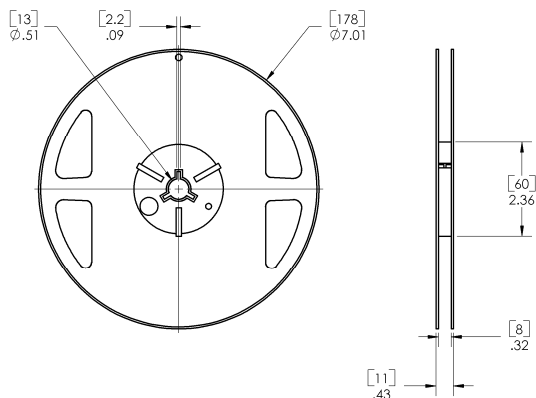

Carrier Tape Dimensions: Loaded quantity 2000 pieces per reel

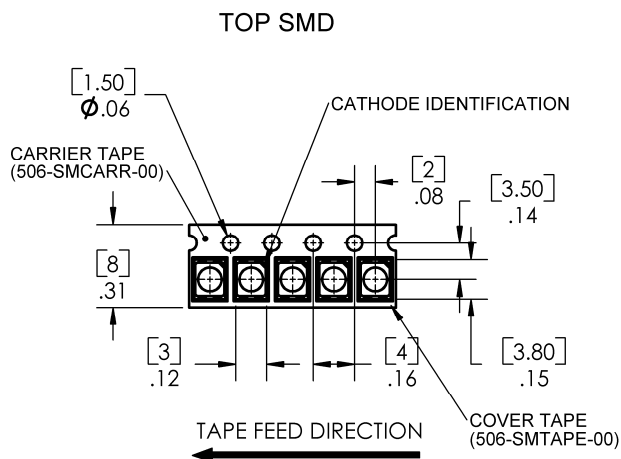

Moisture Resistant Packaging

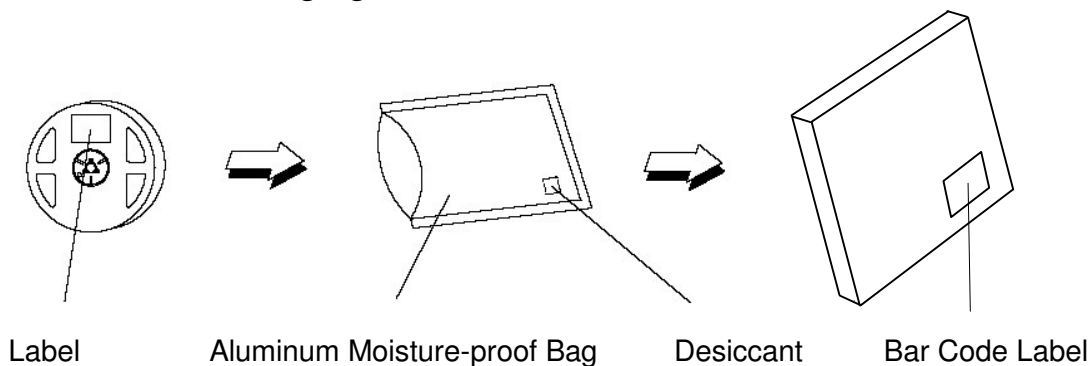

OPTEK reserves the right to make changes at any time in order to improve design and to supply the best product possible.