

Series 400 - Ceramics

thin film technology



preliminary

Features

- size 3,0(L) x 2,0(W) x 1,0(H) mm
- circuit substrate: Al₂O₃ Ceramics
- devices are ROHS conform
- lead free solderable, soldering pads: gold plated
- taped in 8 mm blister tape, cathode to transporting perforation
- all devices sorted into luminous intensity classes
- taping: face-up (T)
- high luminous intensity types
- sorted in color-temperatur (CCT) classes

Absolute Maximum Ratings

$I_{F, max}$ [mA]	$I_{F, P}$ [mA] $t_p \leq 100 \mu s$ $\tau=1: 10$	V_R [V]	I_R, max [μA]	Thermal resistance R_{thJA} [K / W]	T_{Op} [$^{\circ}C$]	T_{St} [$^{\circ}C$]
30	100	5	100	60	-40...85	-40...100

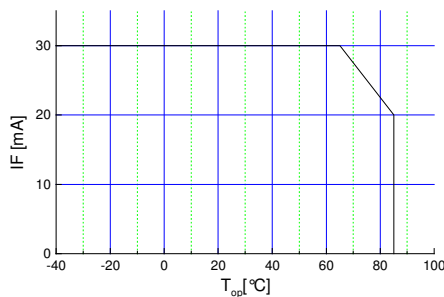

Maximal forward current (DC) characteristic

electrostatic discharge classification (MIL-STD-883E)

class 1

Electro-Optical Characteristics

Type	Emitting color	Marking at	Measurement I_F [mA]	V_F [V]		color coordinates	I_V [mcd]	
				typ	max		min	typ
OCL-400 EW	white	anode	20	3,2	3,8	0,32/0,33	300	500
OCL-400 EWW	warm white	anode	20	3,2	3,8	0,45/0,41	300	500

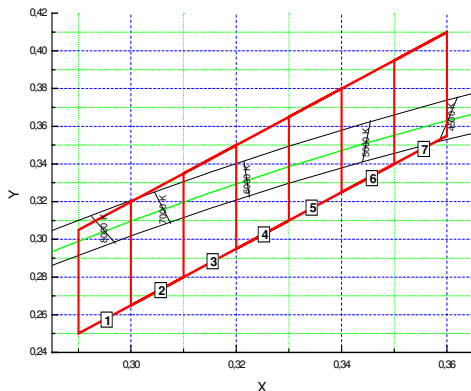

white

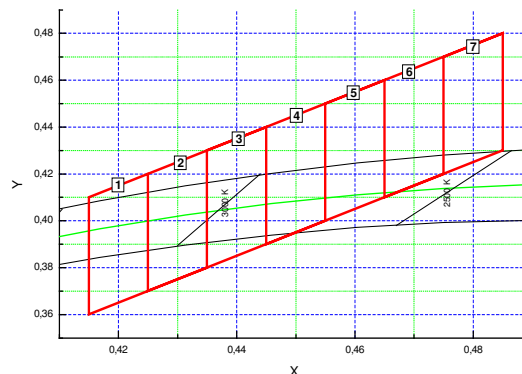

warm white

color coordinates classes

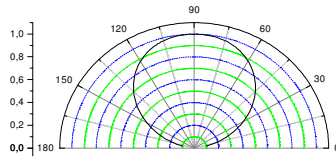

view angle

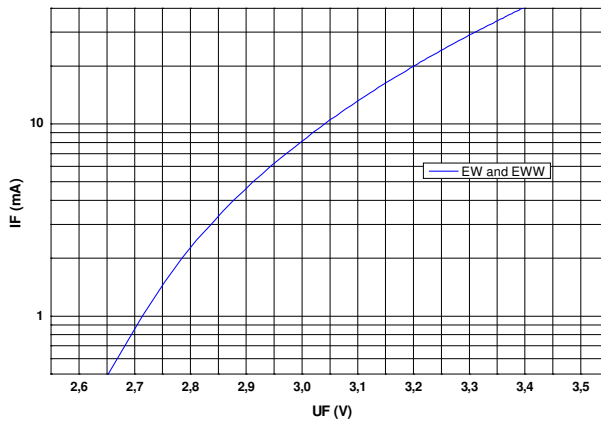

$I_F - U_F$
characteristic

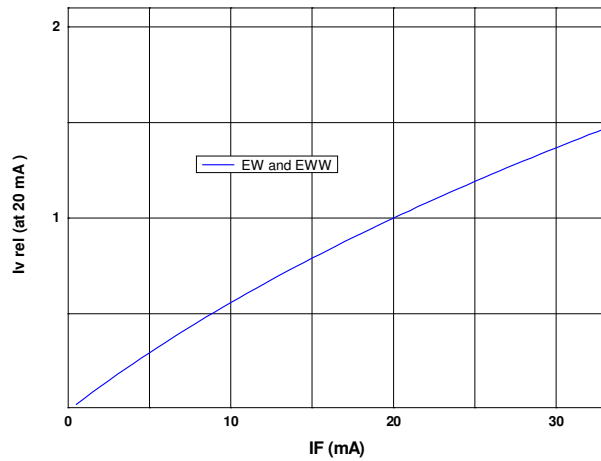

$I_F - I_{v,rel}$
characteristic

Outline Drawing

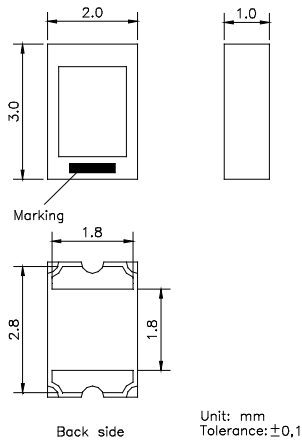

Recommended Soldering Patterns

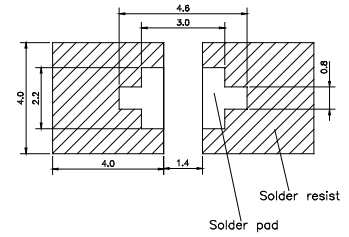

Soldering Conditions

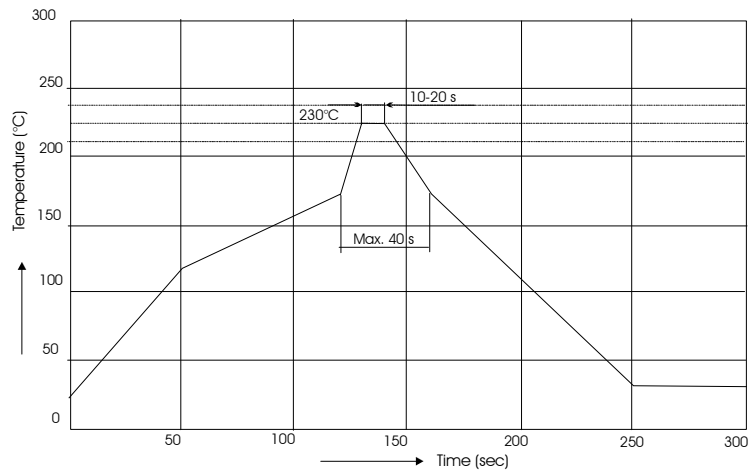

IR reflow soldering profile

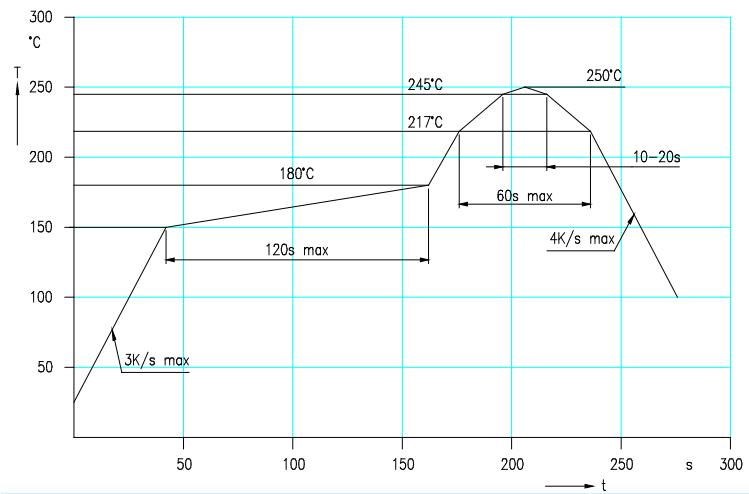

IR reflow soldering profile for lead free soldering

Manual soldering: max power of iron 25W/ 3s/ 300°C

Ordering Code For Parts

Series	Color	Encapsulation	Packaging
OCL-400	???????	XD	T
			T - taped
		XD - uncolored diffused	

Type definition, e.g. OCL-400 EW-XD-T

LED Luminous Intensity Groups And Subgroups [mcd]

(general information – not this device specific)

C:	0.28 - 0.45	C1:	0.28 - 0.36	Q1:	71 - 90
D:	0.45 - 0.71	C2:	0.36 - 0.45	Q2:	90 - 112
E:	0.71 - 1.12	D1:	0.45 - 0.56	R1:	112 - 140
F:	1.12 - 1.80	D2:	0.56 - 0.71	R2:	140 - 180
G:	1.80 - 2.80	E1:	0.71 - 0.90	S1:	180 - 224
H:	2.80 - 4.50	E2:	0.90 - 1.12	S2:	224 - 280
J:	4.50 - 7.10	F1:	1.12 - 1.40	T1:	280 - 355
K:	7.10 - 11.20	F2:	1.40 - 1.80	T2:	355 - 450
L:	11.20 - 18.00	G1:	1.80 - 2.24	U1:	450 - 560
		G2:	2.24 - 2.80	U2:	560 - 710
M:	18 - 28	H1:	2.80 - 3.55	V1:	710 - 900
N:	28 - 45	H2:	3.55 - 4.50	V2:	900 - 1120
P:	45 - 71	J1:	4.50 - 5.60	W1:	1120 - 1420
Q:	71 - 112	J2:	5.60 - 7.10	W2:	1420 - 1800
R:	112 - 180	K1:	7.10 - 9.00	X1:	1800 - 2250
S:	180 - 280	K2:	9.00 - 11.20	X2:	2250 - 2800
T:	280 - 450	L1:	11.20 - 14.00	Y1:	2800 - 3550
U:	450 - 710	L2:	14.00 - 18.00	Y2:	3550 - 4500
V:	710 - 1120	M1:	18.00 - 22.40	Z1:	4500 - 5750
W:	1120 - 1800	M2:	22.40 - 28.00	Z2:	5750 - 7100
X:	1800 - 2800	N1:	28.00 - 35.50		
Y:	2800 - 4500	N2:	35.50 - 45.00		
Z:	4500 - 7100	P1:	45.00 - 56.00		
		P2:	56.00 - 71.00		

Measured according to CIE 127. All SMD-LEDs are 100% measured and selected on full automated equipment with an accuracy of ± 11 %.

**Special service: Brightness selection in subselections possible.
Color selection in subselections possible (each subgroup per reel).**

Attention please:

The LED output is strong enough to injure human eyes. Precautions must be taken to prevent locking directly at the LED with unaided eyes for more than a few seconds. Flashing lights have been known to cause discomfort in people, you can prevent this by taking precautions during use. Also, people should be cautious when using equipment where these LED's are incorporated.

Tape And Reel Packing

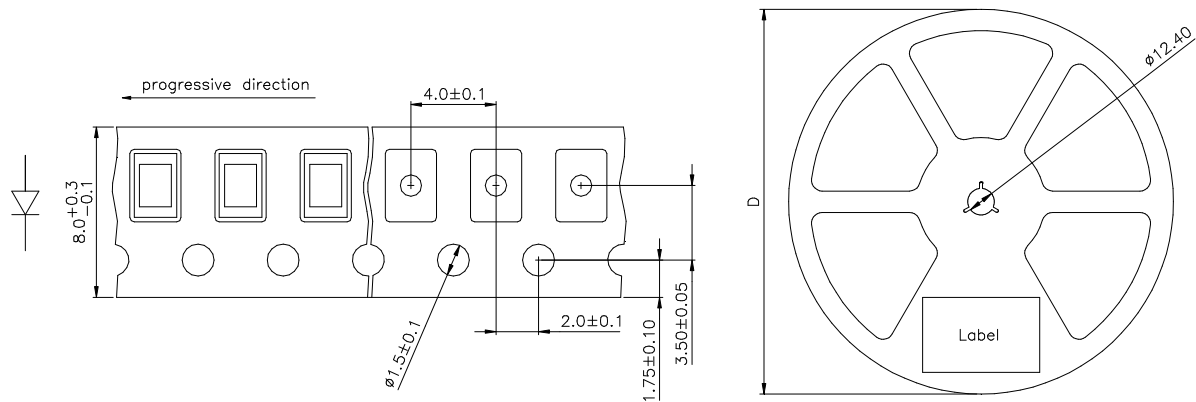

D	Parts/reel
180 mm	2000
330 mm	8000

Packing: The reel is sealed in special plastic bag with integrate ESD protection (MIL - STD 81705) including a silica dry-pack

Label

Order No.	XXXXXXXXXX	Customer order No.
Type	OCL-400 ?????-??-T	
Intensity group	ZZ	Color class: CC
Charge No.	1122-AAAAAA	11 Week – 22 year – A internal identification
Quantity	9999	

Attention please:

The information describes the type of component and shall not considered as assured characteristics. Terms of delivery and rights to change reserved.

Due to technical requirements components may contain dangerous substances.

The data sheet may be changed without prior information; the valid issue will be on our webpage in internet.

Packaging:

Please use the recycling operators known to you.

Components used in life support devices or systems and safety systems must be expressly authorized for such purpose!