

KP-1608SYC SUPERBRIGHTYELLOW

Features

- 1.6mmx0.8mm SMT LED, 1.1mm THICKNESS.
- LOW POWER CONSUMPTION.
- WIDE VIEWING ANGLE.
- IDEAL FOR BACKLIGHT AND INDICATOR.
- VARIOUS COLORS AND LENS TYPES AVAILABLE.
- PACKAGE : 2000PCS / REEL.

Description

The Super Bright Yellow source color devices are made with DH InGaAlP on GaAs substrate Light Emitting Diode.

Package Dimensions

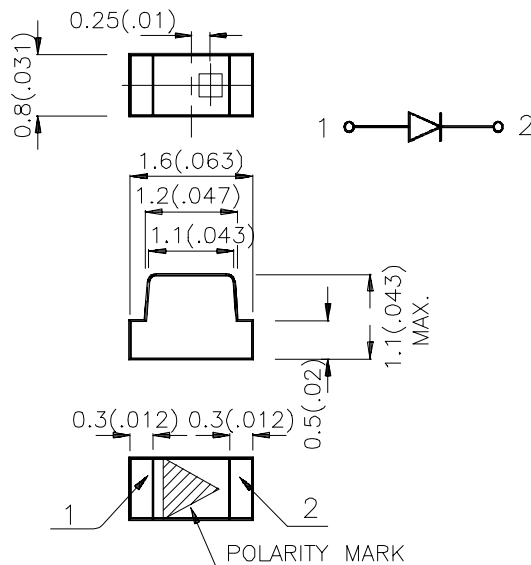

Notes:

1. All dimensions are in millimeters (inches).
2. Tolerance is $\pm 0.1(0.004)$ unless otherwise noted.
3. Lead spacing is measured where the lead emerge package.
4. Specifications are subject to change without notice.

Selection Guide

Part No.	Dice	Lens Type	Iv (mcd) @ 20 mA		Viewing Angle
			Min.	Typ.	2θ1/2
KP-1608SYC	SUPER BRIGHT YELLOW (InGaAlP)	WATER CLEAR	40	80	120°

Note:

1. θ1/2 is the angle from optical centerline where the luminous intensity is 1/2 the optical centerline value.

Electrical / Optical Characteristics at T_A=25°C

Symbol	Parameter	Device	Typ.	Max.	Units	Test Conditions
λ _{peak}	Peak Wavelength	Super Bright Yellow	590		nm	IF=20mA
λ _D	Dominate Wavelength	Super Bright Yellow	588		nm	IF=20mA
Δλ _{1/2}	Spectral Line Halfwidth	Super Bright Yellow	28		nm	IF=20mA
C	Capacitance	Super Bright Yellow	25		pF	VF=0V;f=1MHz
V _F	Forward Voltage	Super Bright Yellow	2.0	2.5	V	IF=20mA
I _R	Reverse Current	Super Bright Yellow		10	μA	VR = 5V

Absolute Maximum Ratings at T_A=25°C

Parameter	Super Bright Yellow	Units
Power dissipation	125	mW
DC Forward Current	30	mA
Peak Forward Current [1]	175	mA
Reverse Voltage	5	V
Operating Temperature	-40°C To +85°C	
Storage Temperature	-40°C To +85°C	

Note:

1. 1/10 Duty Cycle, 0.1ms Pulse Width.

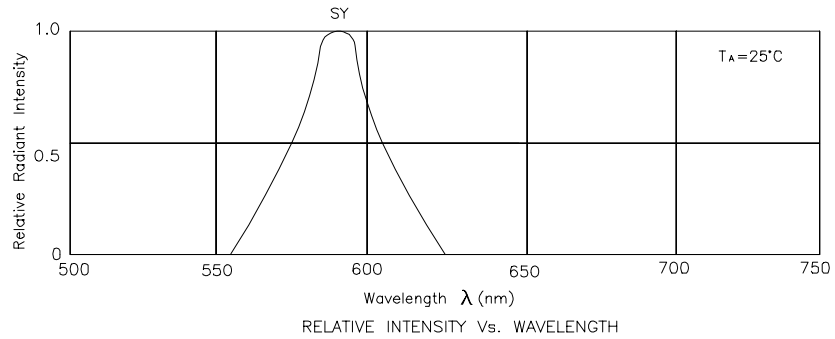

Super Bright Yellow KP-1608SYC

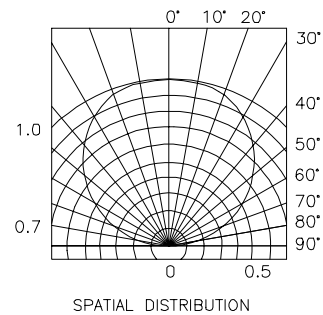
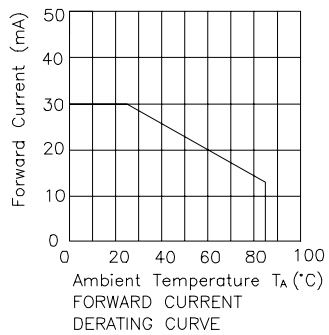
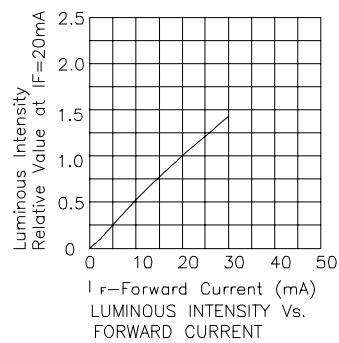
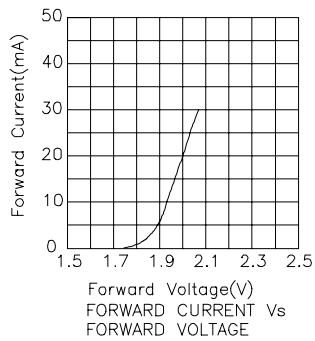

KP-1608SYC SMT Reflow Soldering Instructions

Number of reflow process shall be less than 2 times and cooling process to normal temperature is required between first and second soldering process.

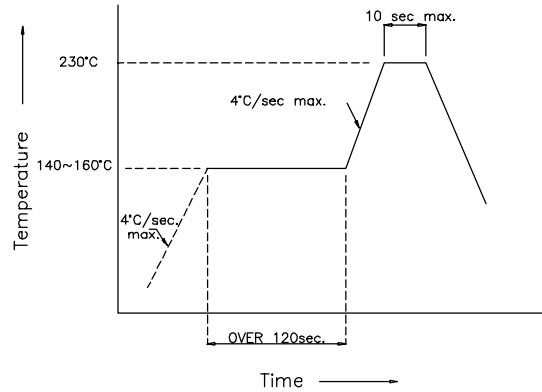

Recommended Soldering Pattern (Units : mm)

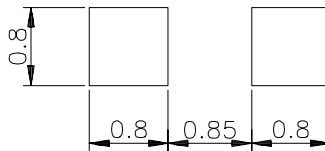

Tape Specifications (Units : mm)

