

PLCC4 Surface Mount LED with Dome Lens

OVSA1xBLCR8 Series

- High intensity with low power consumption
- PLCC4 packaged in 8 mm tape on 7" diameter reel
- Compatible with automatic placement equipment
- Dimensions: 3.5 x 2.8 x 1.95 mm
- 60° viewing angle

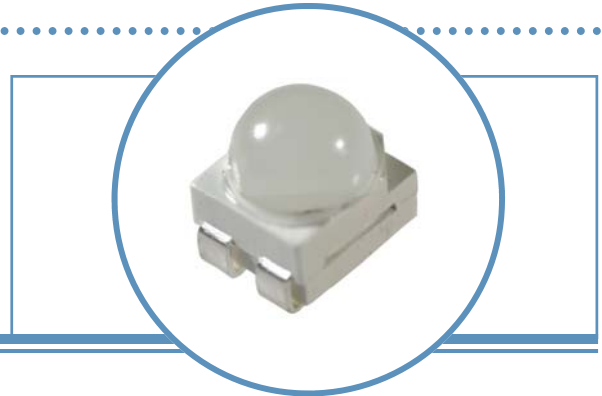

The **OVSA1xBLCR8** series is designed for focused, uniform light output. Its internal reflector and colorless clear lens optimize luminous intensity and make it ideal for backlighting applications and for coupling with light guides.

Applications

- Traffic lights
- Signal and symbol luminaire
- Mono-color indicators
- Backlighting (LCD, switches, displays, illuminated advertising)
- Interior automotive lighting (instrumentation clusters)
- Safety marker lights (steps, exit ways)

Part Number	Material	Emitted Color	Intensity Typ. mcd	Lens Color
OVSA1ABLCR8	AllnGaP	Amber	5000	Water Clear
OVSA1SBLCR8	AllnGaP	Red	3700	Water Clear

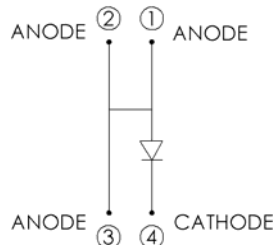
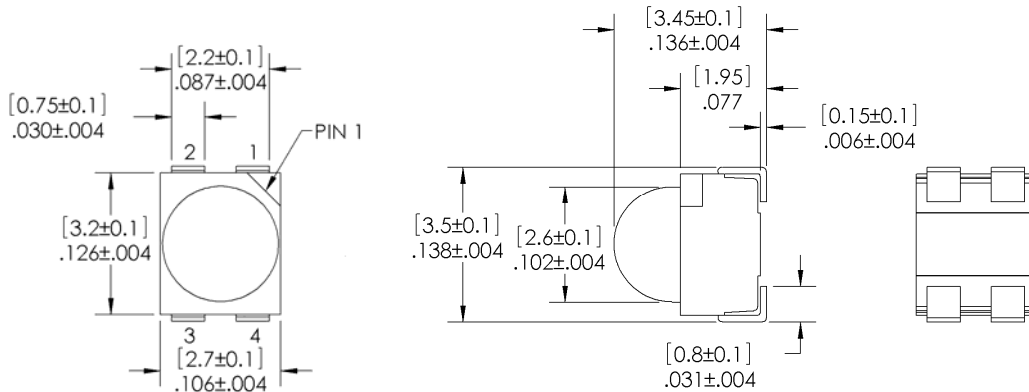

DIMENSIONS ARE IN INCHES AND [MM]

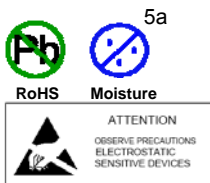

DO NOT LOOK DIRECTLY AT RED WITH UNSHIELDED EYES OR DAMAGE TO RETINA MAY OCCUR.

OPTEK reserves the right to make changes at any time in order to improve design and to supply the best product possible.

PLCC4 Surface Mount Dome LED

OVSA1xBLCR8 Series

Absolute Maximum Ratings (T_A = 25° C unless otherwise noted)

Storage Temperature Range	-40 ~ +100 °C
Operating Temperature Range	-40 ~ +100 °C
Reverse Voltage	5 V
Continuous Forward Current	70 mA
Peak Forward Current (Pulse width ≤10 msec, duty cycle ≤10%)	200 mA
Power Dissipation	210 mW
Thermal Resistance Junction to Solder ¹	150° C/W
Electrostatic Discharge Classification (MIL-STD-883E)	Class 2
LED Junction Temperature	110° C
Lead Soldering Temperature	250° C / 10 seconds

Note:

1. Rth test condition: Mounted on PC board FR 4 (pad size ≥ 16 mm²)

Electrical Characteristics (T_A = 25° C unless otherwise noted)

SYMBOL	PARAMETER	COLOR	MIN	TYP	MAX	UNITS	CONDITIONS
I _V	Luminous Intensity	Red	2240	3700		mcd	I _F = 50 mA
		Amber	3550	5000			
V _F	Forward Voltage		---	2.5	3.0	V	I _F = 50 mA
I _R	Reverse Current		---	---	10	μA	V _R = 5 V
λ _D	Dominant Wavelength	Red	618	624	630	nm	I _F = 50 mA
		Amber	584	591	599		
2Θ _{1/2} H-H	50% Power Angle			60		deg	I _F = 50 mA

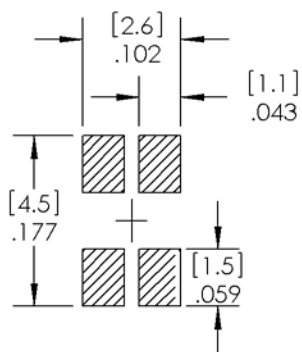

RECOMMENDED SOLDER PASTE PATTERN

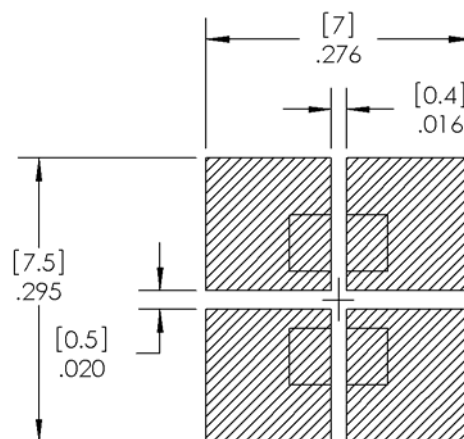

RECOMMENDED COPPER PATTERN

OPTeK reserves the right to make changes at any time in order to improve design and to supply the best product possible.

PLCC4 Surface Mount Dome LED

OVSA1xBLCR8 Series



Standard Bins

LEDs are sorted to luminous intensity (I_v) and dominant wavelength (nm) bins listed below. Each reel consists of a single intensity bin and a single color bin. Orders are filled using all intensity and color bins listed in the following tables. Optek will not accept orders for single intensity bins or single color bins.

Luminous Intensity (I_v) @ 50mA

RED: OVSA1SBLCR8		
IV Code	Min (mcd)	Max (mcd)
Xb	2240	2800
Ya	2800	3550
Yb	3550	4500
Z0	4500	5600

Dominant Wavelength (nm)

RED: OVSA1SBLCR8		
nm Code	Min	Max
RA	618	630

AMBER: OVSA1ABLCR8		
IV Code	Min (mcd)	Max (mcd)
Yb	3550	4500
Z0	4500	5600
A0	5600	7100
B0	7100	9000

AMBER: OVSA1ABLCR8		
nm Code	Min	Max
A2	584	587
A3	587	590
A4	590	593
A5	593	596
A6	596	599

Reflow Solder Profile

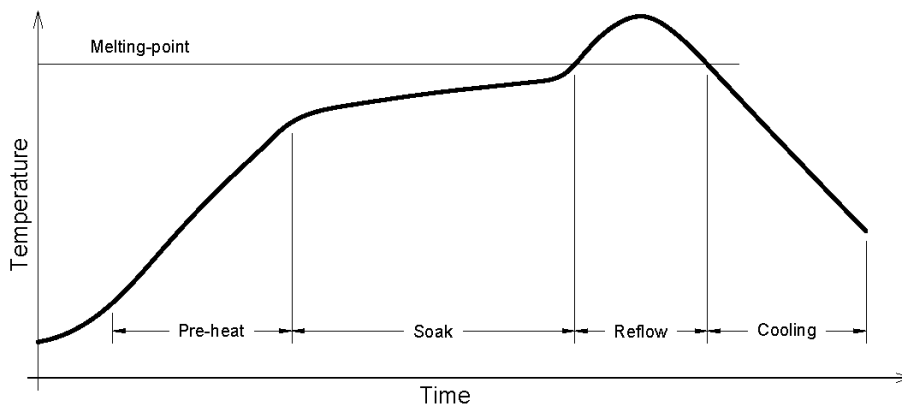

Solder = Lead-Free	
Average ramp-up rate = 4°C / sec. max	Peak temperature = 250°C max.
Preheat temperature: 150 - 220°C	Time within 5°C of actual peak temperature = 10 sec. max
Preheat time: 120 sec. max.	
Ramp-down rate = 6°C / sec. max.	Duration above 217°C is 60 sec. max

OPTEK reserves the right to make changes at any time in order to improve design and to supply the best product possible.

PLCC4 Surface Mount Dome LED

OVSA1xBLCR8 Series



Typical Electro-Optical Characteristics Curves for OVSA1SBLCR8 (Red) & OVSA1ABLCR8 (Amber)

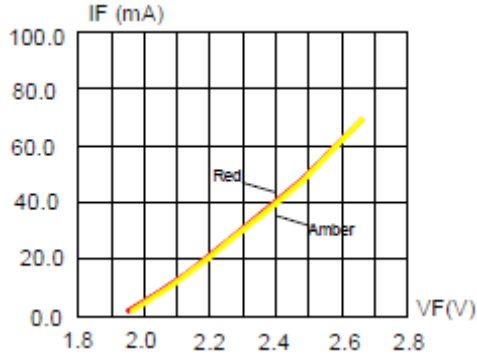

Forward Current vs. Forward Voltage

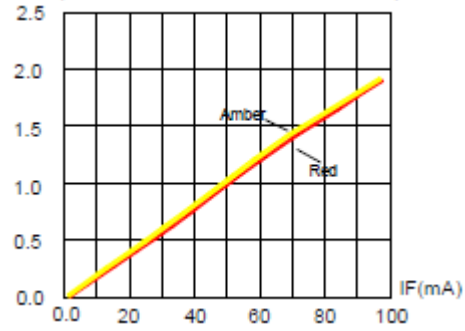

Relative Luminous Intensity vs. Forward Current

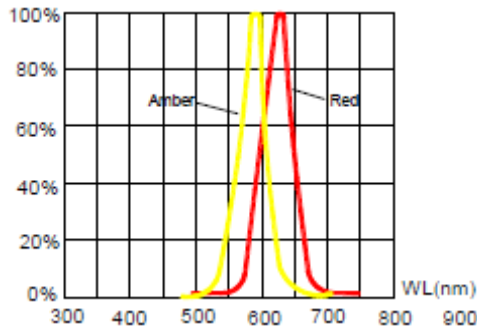

Relative Luminous Intensity vs. Wavelength

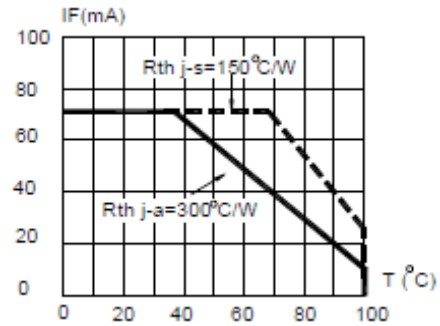

Red & Amber Maximum Forward DC Current vs. Ambient

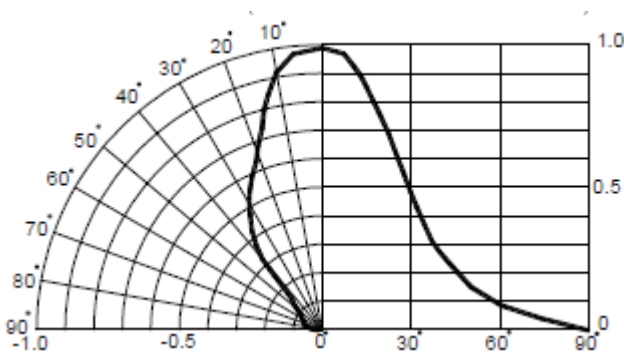

Angular Distribution

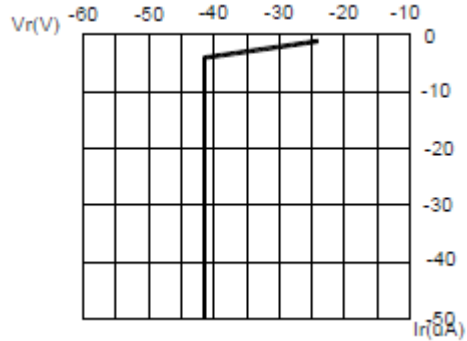

Red & Amber Reverse Current vs. Reverse Voltage

OPTEK reserves the right to make changes at any time in order to improve design and to supply the best product possible.

