

White PLCC2 Surface Mount LED

OVS9WBCR4

- High luminous intensity
- High efficiency
- Emission color: $x = 0.315, y = 0.335$
- Pb-free

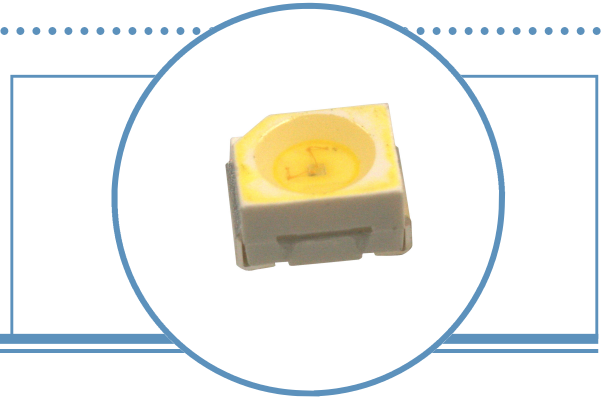

The **OVS9WBCR4** provides high intensity light from a surface mount package. Light output is optimized by an interior reflector and the wide viewing angle adds flexibility for applications ranging from hand-held appliances to automotive interiors.

Applications

- Backlighting of full color LCD
- Automotive interior lighting
- General lighting
- Coupling into light guides
- Entertainment equipment

Part Number	Material	Emitted Color	Intensity Typ. mcd	Lens Color
OVS9WBCR4	InGaN	White	750	Water Clear

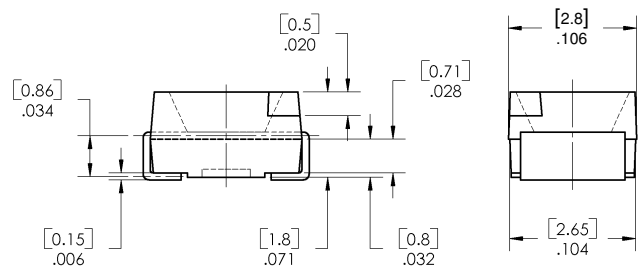
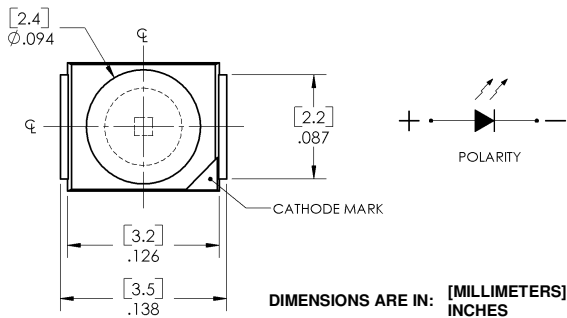

RECOMMENDED SOLDER PADS

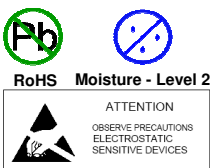
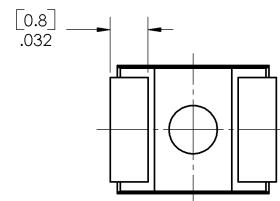
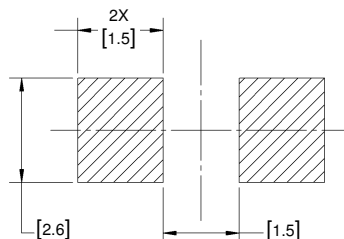

DO NOT LOOK DIRECTLY AT LED WITH UNSHIELDED EYES OR DAMAGE TO RETINA MAY OCCUR.

OPTEK reserves the right to make changes at any time in order to improve design and to supply the best product possible.

White PLCC2 Surface Mount LED

OVS9WBCR4



Absolute Maximum Ratings

$T_A = 25^\circ\text{C}$ unless otherwise noted

Storage Temperature Range	-40 ~ +100° C
Operating Temperature Range	-40 ~ +100° C
Soldering Temperature (10 - 30 seconds maximum)	260° C
Reverse Voltage	5 V
Continuous Forward Current	20 mA
Peak Forward Current ($T_P \leq 10 \mu\text{s}$, Duty Cycle = 0.005)	200 mA
Electrostatic Discharge (ESD Threshold [HBM])	2000 V
Power Dissipation (at room temperature)	85 mW
LED Junction Temperature	125° C

Electrical Characteristics

$T_A = 25^\circ\text{C}$ unless otherwise noted

SYMBOL	PARAMETER	MIN	TYP	MAX	UNITS	CONDITIONS
I_V	Luminous Intensity	560	750	1125	mcd	$I_F = 20 \text{ mA}$
V_F	Forward Voltage	2.9	3.2	3.8	V	$I_F = 20 \text{ mA}$
I_R	Reverse Current	----	----	10	μA	$V_R = 5 \text{ V}$
$2 \Theta_{1/2}$	50% Power Angle	----	120	----	deg	$I_F = 20 \text{ mA}$
Chromaticity Coordinates	x	----	0.3150	----	----	$I_F = 20 \text{ mA}$
	y	----	0.3354	----	----	$I_F = 20 \text{ mA}$

Standard Bins ($I_F = 20 \text{ mA}$)

Lamps are sorted to luminous intensity (I_V) and chromaticity coordinates (x, y) bins shown. Orders for OVS9WBCR4 may be filled with any or all bins contained as below.

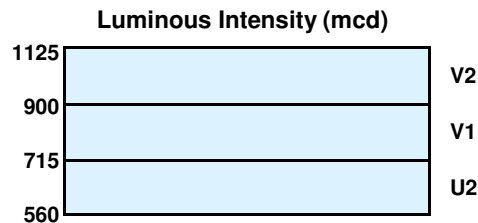

Notes:

1. All ranks will be included per delivery, rank ratio will be based on the chip distribution.
2. Pb content <1000 PPM.
3. To designate luminous intensity ranks or chromaticity bins, please contact OPTEK.
4. Part is sensitive to static electricity and precautions must be used when handling products.

OPTEK reserves the right to make changes at any time in order to improve design and to supply the best product possible.

White PLCC2 Surface Mount LED

OVS9WBCR4



White Color Grouping

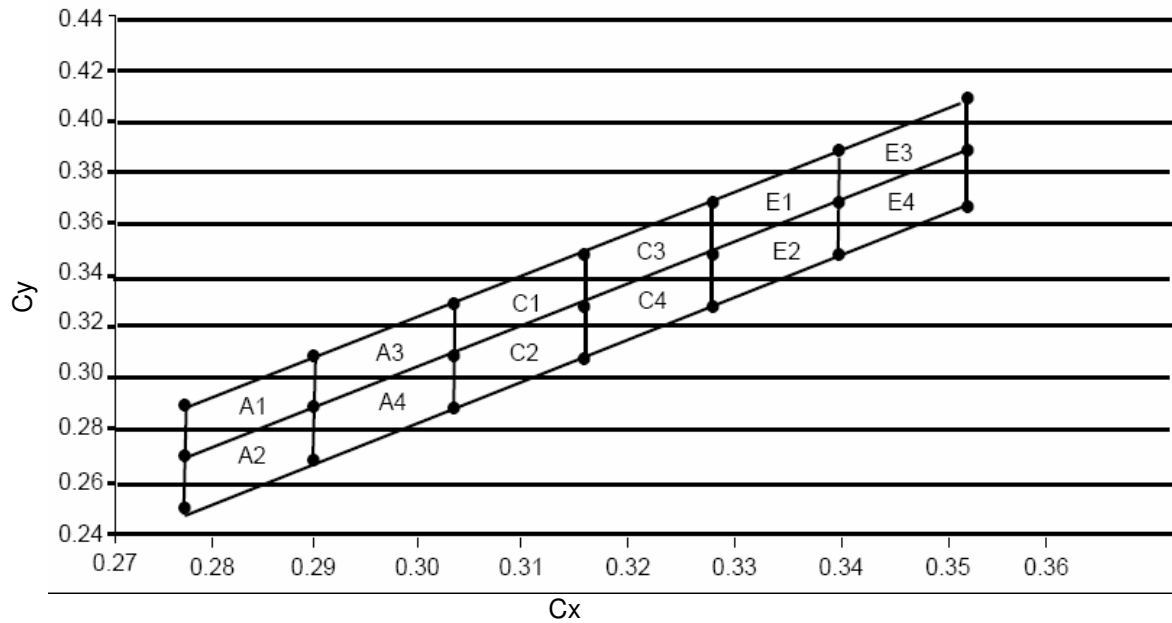

Bin					
A1	Cx	0.2775	0.2900	0.2900	0.2775
	Cy	0.2732	0.2939	0.3114	0.2907
A2	Cx	0.2775	0.2900	0.2900	0.2775
	Cy	0.2557	0.2764	0.2939	0.2732
A3	Cx	0.2900	0.3025	0.3025	0.2900
	Cy	0.2939	0.3146	0.3321	0.3114
A4	Cx	0.2900	0.3025	0.3025	0.2900
	Cy	0.2764	0.2971	0.3146	0.2939
C1	Cx	0.3025	0.3150	0.3150	0.3025
	Cy	0.3146	0.3354	0.3529	0.3321
C2	Cx	0.3025	0.3150	0.3150	0.3025
	Cy	0.2971	0.3179	0.3354	0.3146
C3	Cx	0.3150	0.3275	0.3275	0.3150
	Cy	0.3354	0.3561	0.3736	0.3529
C4	Cx	0.3150	0.3275	0.3275	0.3150
	Cy	0.3179	0.3386	0.3561	0.3354

Bin					
E1	Cx	0.3275	0.3400	0.3400	0.3275
	Cy	0.3561	0.3768	0.3943	0.3736
E2	Cx	0.3275	0.3400	0.3400	0.3275
	Cy	0.3386	0.3593	0.3768	0.3561
E3	Cx	0.3400	0.3525	0.3525	0.3400
	Cy	0.3768	0.3975	0.4150	0.3943
E4	Cx	0.3400	0.3525	0.3525	0.3400
	Cy	0.3593	0.3800	0.3975	0.3768

OPTEK reserves the right to make changes at any time in order to improve design and to supply the best product possible.

White PLCC2 Surface Mount LED

OVS9WBCR4

Forward Current Vs Forward Voltage

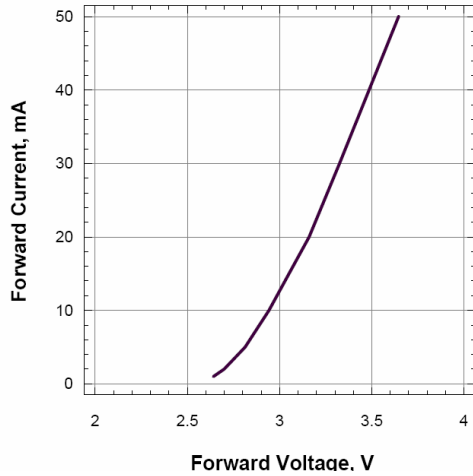

Relative Luminous Intensity Vs Forward Current

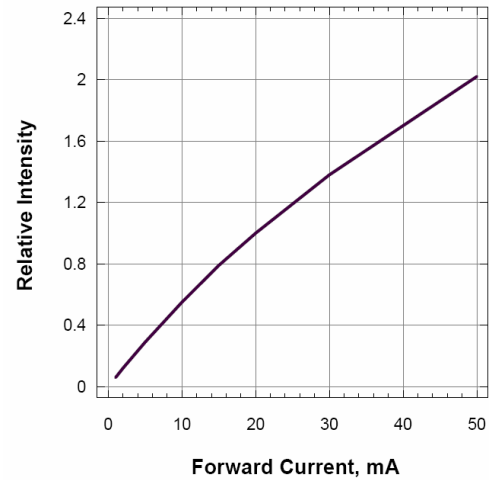

Relative Intensity Vs. Wavelength

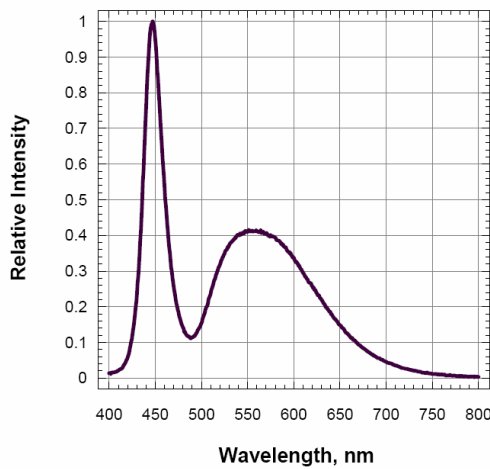

Maximum Current Vs Ambient Temperature

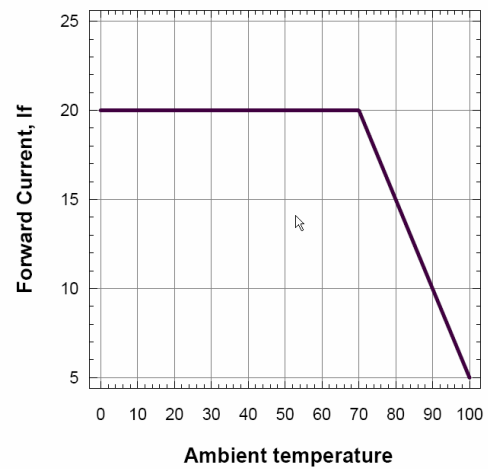

Radiation Pattern

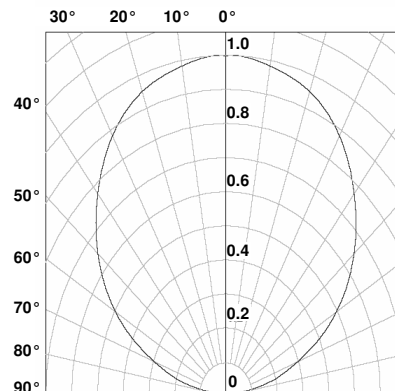

OPTEK reserves the right to make changes at any time in order to improve design and to supply the best product possible.

White PLCC2 Surface Mount LED OVS9WBCR4

Reel Dimensions: 7-inch reel

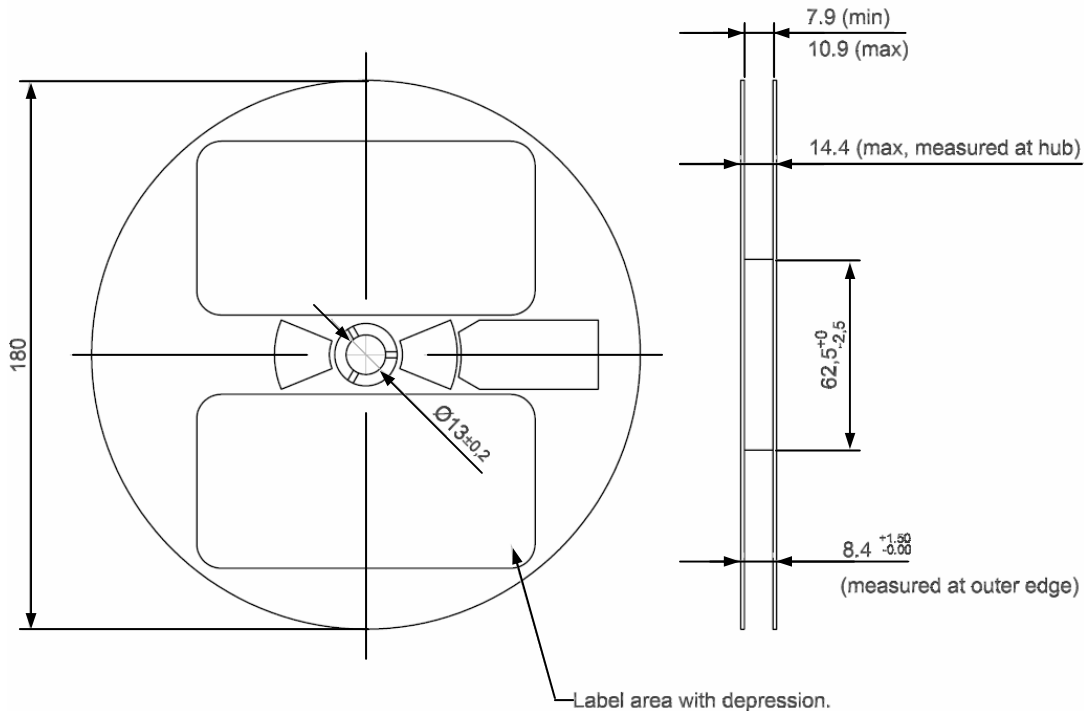

Carrier Tape Dimensions: Loaded quantity 2000 pieces per reel

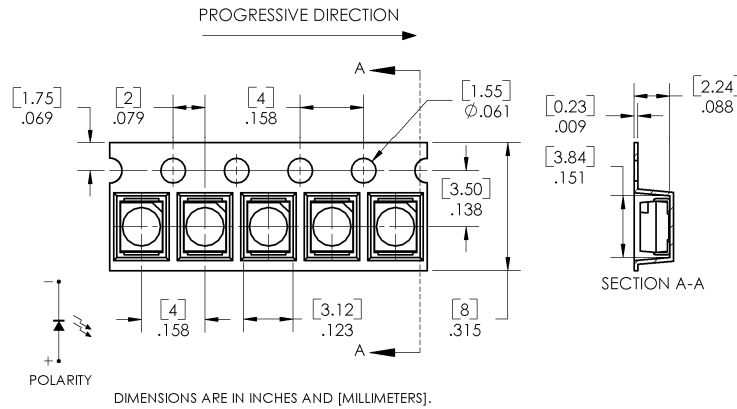

Moisture Resistant Packaging

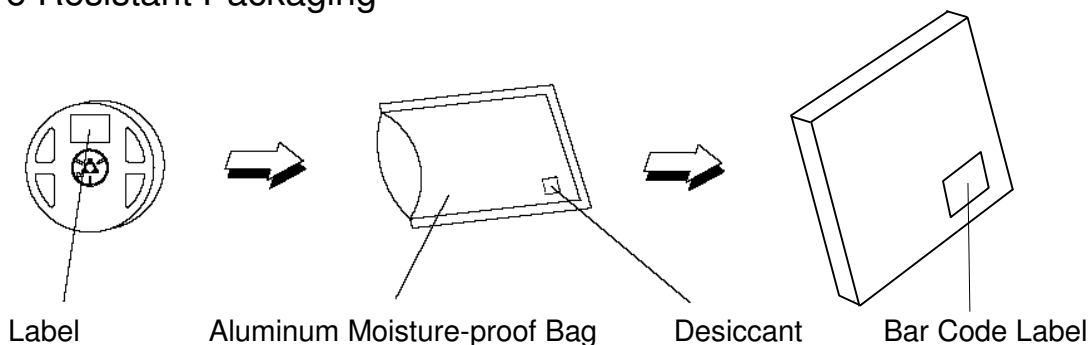

OPTEK reserves the right to make changes at any time in order to improve design and to supply the best product possible.

Recommended Sn-Pb IR-Reflow Soldering Profile

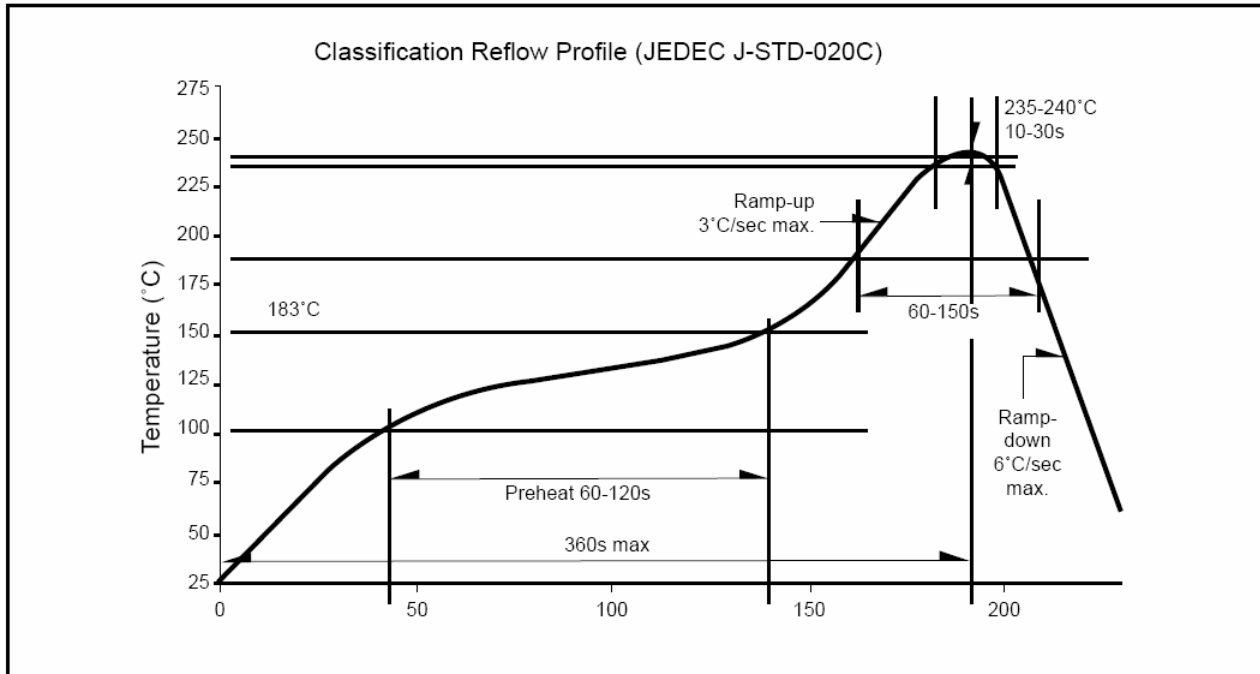

Recommended Pb-free Soldering Profile

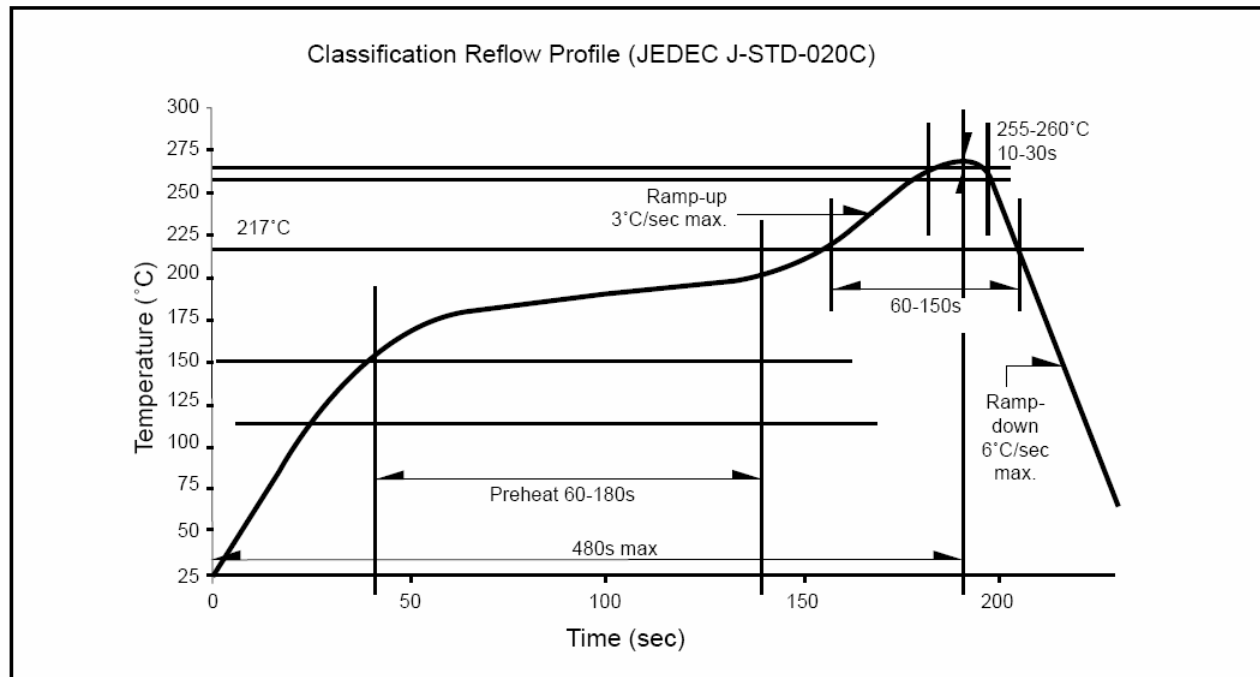

OPTEK reserves the right to make changes at any time in order to improve design and to supply the best product possible.