

Resistor LED for 12 V Supply Voltage

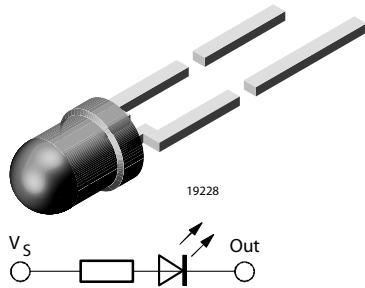

DESCRIPTION

These devices are developed for the automotive industry with special requirements as for EMC (electro magnetic compatibility) in motor vehicles with 12 V supply voltage.

They are resistant against transient conduction (high voltage spikes) and interferences by conduction and coupling.

The TLR.4420CU series contains an integrated resistor for current limiting in series with the LED chip. This allows the lamp to be driven from a 12 V source without an external current limiter.

Available colors are red, soft orange, yellow and green. These tinted diffused lamps provide a wide off-axis viewing angle.

These LEDs are intended for space critical applications such as automobile instrument panels, switches and others which are driven from a 12 V source.

FEATURES

- With current limiting resistor for 12 V
- EMC specified (DIN 40 839)
- Resistant against transient high voltage spikes
- Cost effective: save space and resistor cost
- Standard \varnothing 3 mm (T-1) package
- Wide viewing angle
- Choice of four bright colors
- Luminous intensity categorized
- Yellow and green color categorized
- Compliant to RoHS directive 2002/95/EC and in accordance to WEEE 2002/96/EC



RoHS
COMPLIANT

APPLICATIONS

- Status light in cars
- Off/on indicator in cars
- Background illumination for switches
- Off/on indicator in switches

PRODUCT GROUP AND PACKAGE DATA

- Product group: LED
- Package: 3 mm
- Product series: resistor
- Angle of half intensity: $\pm 30^\circ$

PARTS TABLE		
PART	COLOR, LUMINOUS INTENSITY	TECHNOLOGY
TLRH4420CU	Red, $I_V > 1.6$ mcd	GaAsP on GaP
TLRO4420CU	Soft orange, $I_V > 4$ mcd	GaAsP on GaP
TLRY4420CU	Yellow, $I_V > 1.6$ mcd	GaAsP on GaP
TLRG4420CU	Green, $I_V > 1.6$ mcd	GaP on GaP

ABSOLUTE MAXIMUM RATINGS ¹⁾, TLRH4420CU , TLRO4420CU , TLR4420CU , TLRG4420CU				
PARAMETER	TEST CONDITION	SYMBOL	VALUE	UNIT
Reverse voltage		V_R	6	V
Forward voltage	$T_{amb} \leq 65\text{ }^\circ\text{C}$	V_F	16	V
Power dissipation	$T_{amb} \leq 65\text{ }^\circ\text{C}$	P_V	240	mW
Junction temperature		T_j	100	$^\circ\text{C}$
Operating temperature range		T_{amb}	- 40 to + 100	$^\circ\text{C}$
Storage temperature range		T_{stg}	- 55 to + 100	$^\circ\text{C}$
Soldering temperature	$t \leq 5\text{ s}$, 2 mm from body	T_{sd}	260	$^\circ\text{C}$
Thermal resistance junction/ambient		R_{thJA}	150	K/W

Note:

¹⁾ $T_{amb} = 25\text{ }^\circ\text{C}$ unless otherwise specified

OPTICAL AND ELECTRICAL CHARACTERISTICS ¹⁾, TLRH4420CU, RED						
PARAMETER	TEST CONDITION	SYMBOL	MIN.	TYP.	MAX.	UNIT
Luminous intensity ²⁾	$V_S = 12\text{ V}$	I_V	1.6	10		mcd
Dominant wavelength	$V_S = 12\text{ V}$	λ_d	612		625	nm
Peak wavelength	$V_S = 12\text{ V}$	λ_p		635		nm
Angle of half intensity	$V_S = 12\text{ V}$	φ		± 30		deg
Forward current	$V_S = 12\text{ V}$	I_F		10	12	mA
Breakdown voltage	$I_R = 10\text{ }\mu\text{A}$	V_{BR}	6	70		V
Junction capacitance	$V_R = 0$, $f = 1\text{ MHz}$	C_j		50		pF

Note:

¹⁾ $T_{amb} = 25\text{ }^\circ\text{C}$ unless otherwise specified

²⁾ In one packing unit $I_{Vmin}/I_{Vmax} \leq 0.5$

OPTICAL AND ELECTRICAL CHARACTERISTICS ¹⁾, TLRO4420CU, SOFT ORANGE						
PARAMETER	TEST CONDITION	SYMBOL	MIN.	TYP.	MAX.	UNIT
Luminous intensity ²⁾	$V_S = 12\text{ V}$	I_V	4	10		mcd
Dominant wavelength	$V_S = 12\text{ V}$	λ_d	598		611	nm
Peak wavelength	$V_S = 12\text{ V}$	λ_p		605		nm
Angle of half intensity	$V_S = 12\text{ V}$	φ		± 30		deg
Forward current	$V_S = 12\text{ V}$	I_F		10	12	mA
Breakdown voltage	$I_R = 10\text{ }\mu\text{A}$	V_{BR}	6	70		V
Junction capacitance	$V_R = 0$, $f = 1\text{ MHz}$	C_j		50		pF

Note:

¹⁾ $T_{amb} = 25\text{ }^\circ\text{C}$ unless otherwise specified

²⁾ In one packing unit $I_{Vmin}/I_{Vmax} \leq 0.5$



OPTICAL AND ELECTRICAL CHARACTERISTICS ¹⁾ , TLR4420CU, YELLOW						
PARAMETER	TEST CONDITION	SYMBOL	MIN.	TYP.	MAX.	UNIT
Luminous intensity ²⁾	$V_S = 12\text{ V}$	I_V	1.6	10		mcd
Dominant wavelength	$V_S = 12\text{ V}$	λ_d	581		594	nm
Peak wavelength	$V_S = 12\text{ V}$	λ_p		585		nm
Angle of half intensity	$V_S = 12\text{ V}$	ϕ		± 30		deg
Forward current	$V_S = 12\text{ V}$	I_F		10	12	mA
Breakdown voltage	$I_R = 10\ \mu\text{A}$	V_{BR}	6	70		V
Junction capacitance	$V_R = 0, f = 1\text{ MHz}$	C_j		50		pF

Note:

¹⁾ $T_{amb} = 25\text{ }^\circ\text{C}$ unless otherwise specified

²⁾ In one packing unit $I_{Vmin.}/I_{Vmax.} \leq 0.5$

OPTICAL AND ELECTRICAL CHARACTERISTICS ¹⁾ , TLRG4420CU, GREEN						
PARAMETER	TEST CONDITION	SYMBOL	MIN.	TYP.	MAX.	UNIT
Luminous intensity ²⁾	$V_S = 12\text{ V}$	I_V	1.6	10		mcd
Dominant wavelength	$V_S = 12\text{ V}$	λ_d	562		575	nm
Peak wavelength	$V_S = 12\text{ V}$	λ_p		565		nm
Angle of half intensity	$V_S = 12\text{ V}$	ϕ		± 30		deg
Forward current	$V_S = 12\text{ V}$	I_F		10	12	mA
Breakdown voltage	$I_R = 10\ \mu\text{A}$	V_{BR}	6	70		V
Junction capacitance	$V_R = 0, f = 1\text{ MHz}$	C_j		50		pF

Note:

¹⁾ $T_{amb} = 25\text{ }^\circ\text{C}$ unless otherwise specified

²⁾ In one packing unit $I_{Vmin.}/I_{Vmax.} \leq 0.5$

TYPICAL CHARACTERISTICS

$T_{amb} = 25\text{ }^\circ\text{C}$ unless otherwise specified

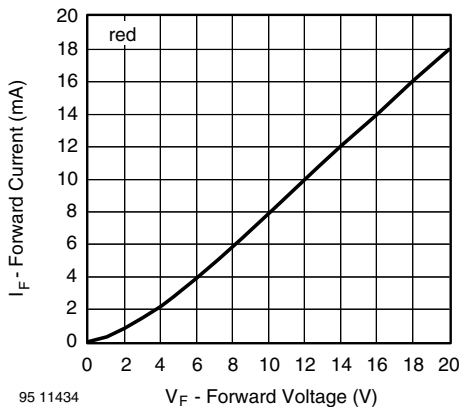

Figure 1. Forward Current vs. Forward Voltage

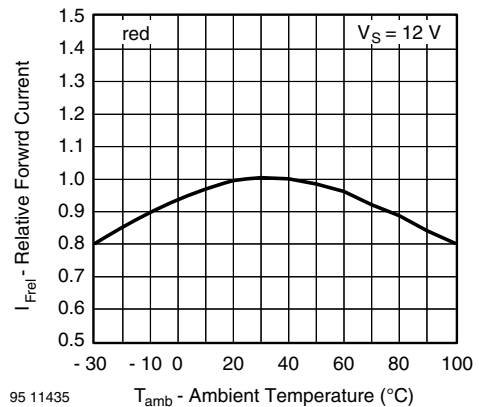

Figure 2. Relative Forward Current vs. Ambient Temperature

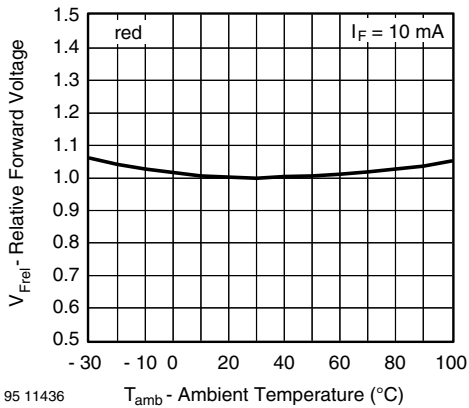

Figure 3. Relative Forward Voltage vs. Ambient Temperature

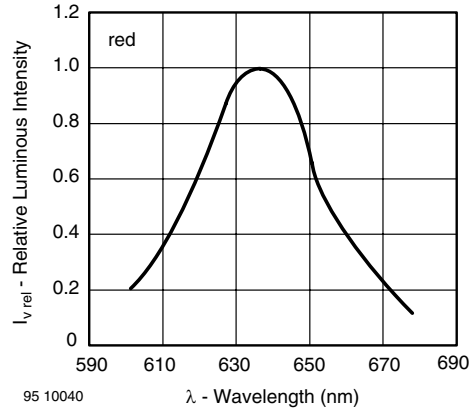

Figure 6. Relative Intensity vs. Wavelength

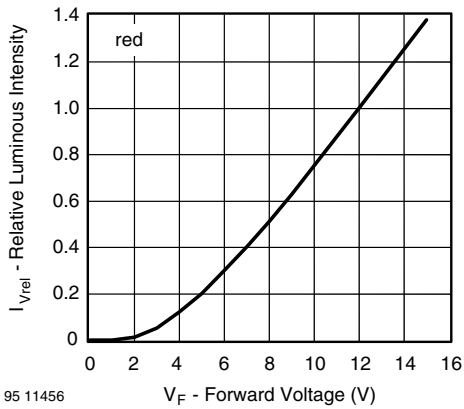

Figure 4. Relative Luminous Intensity vs. Forward Voltage

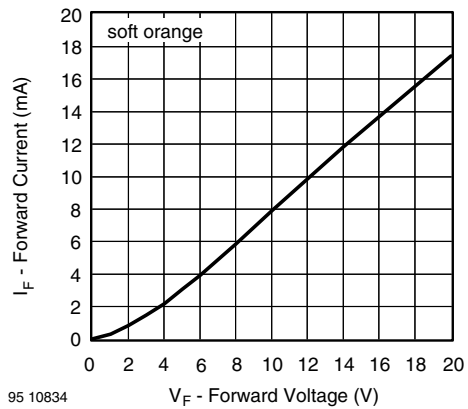

Figure 7. Forward Current vs. Forward Voltage

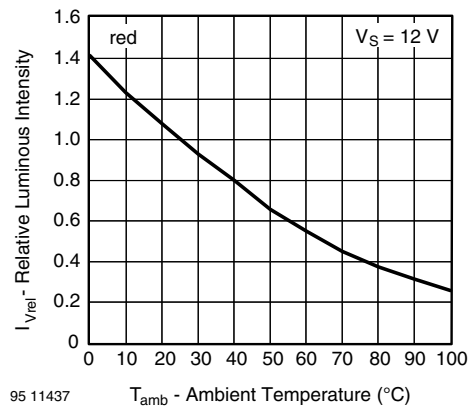

Figure 5. Rel. Luminous Intensity vs. Ambient Temperature

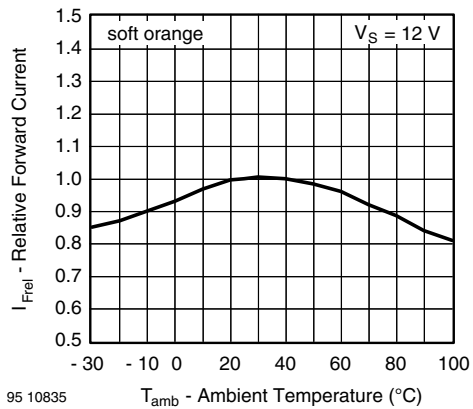

Figure 8. Relative Forward Current vs. Ambient Temperature

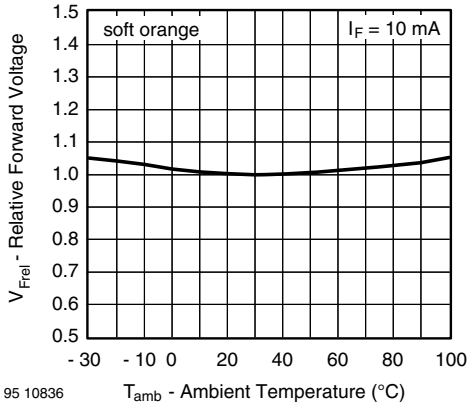

Figure 9. Relative Forward Voltage vs. Ambient Temperature

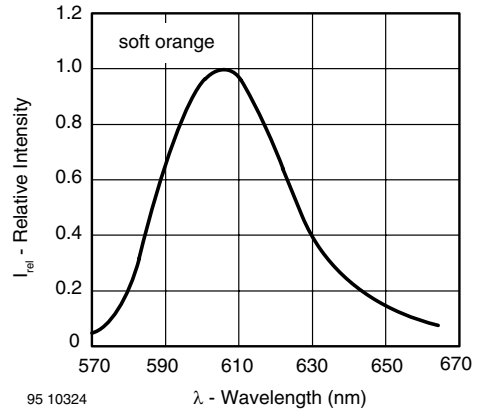

Figure 12. Relative Intensity vs. Wavelength

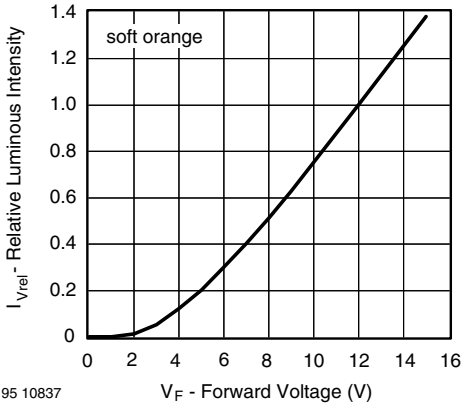

Figure 10. Relative Luminous Intensity vs. Forward Voltage

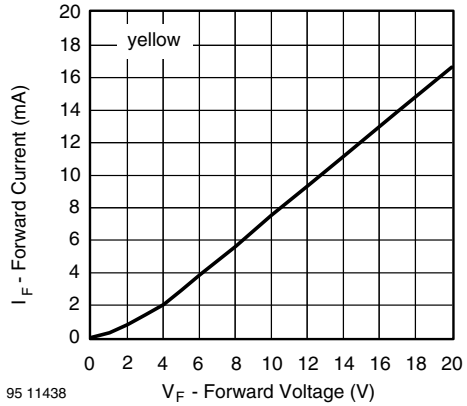

Figure 13. Forward Current vs. Forward Voltage

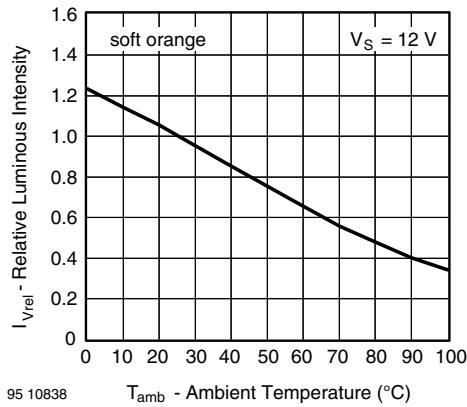

Figure 11. Rel. Luminous Intensity vs. Ambient Temperature

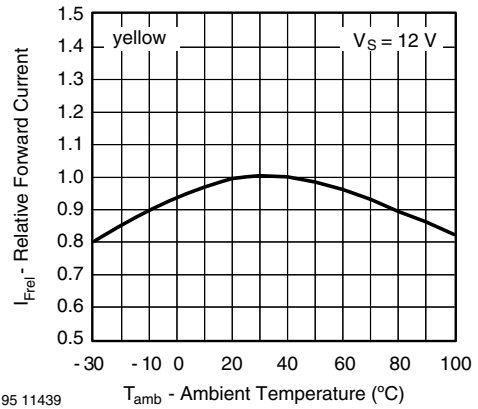

Figure 14. Relative Forward Current vs. Ambient Temperature

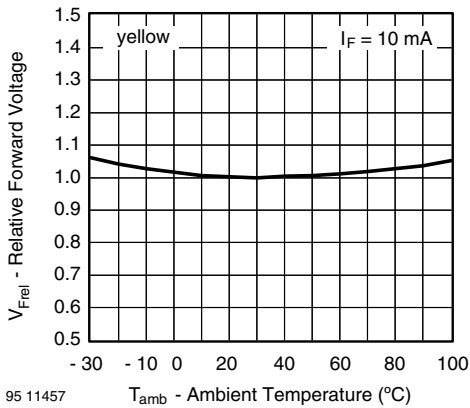

Figure 15. Relative Forward Voltage vs. Ambient Temperature

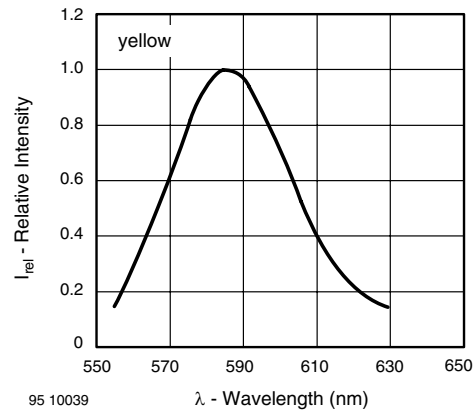

Figure 18. Relative Intensity vs. Wavelength

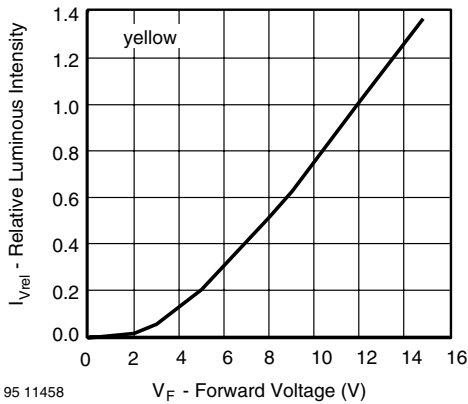

Figure 16. Relative Luminous Intensity vs. Forward Voltage

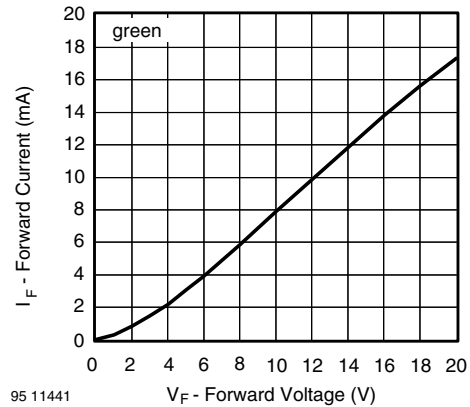

Figure 19. Forward Current vs. Forward Voltage

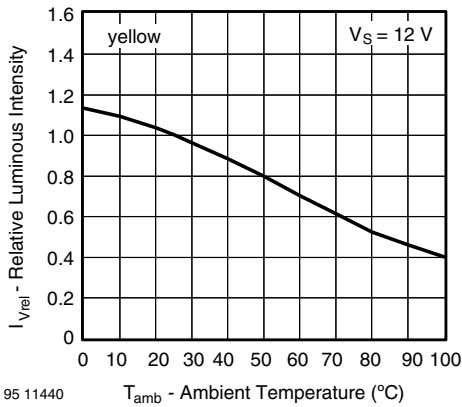

Figure 17. Rel. Luminous Intensity vs. Ambient Temperature

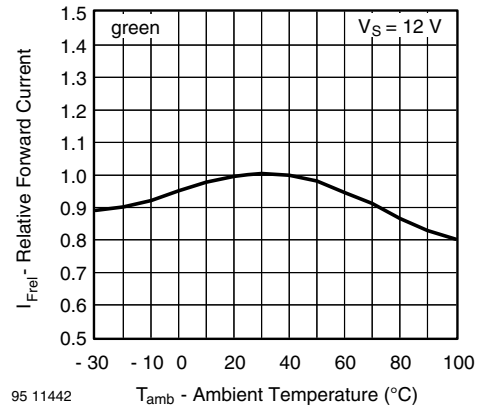

Figure 20. Relative Forward Current vs. Ambient Temperature

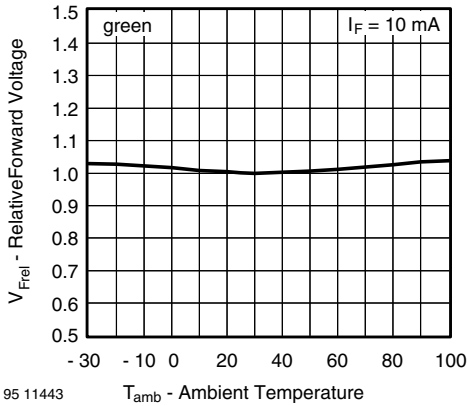

Figure 21. Relative Forward Voltage vs. Ambient Temperature

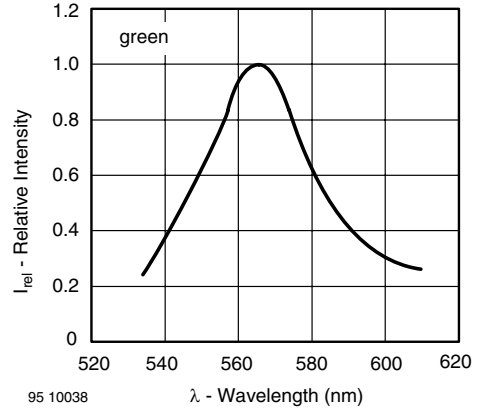

Figure 24. Relative Intensity vs. Wavelength

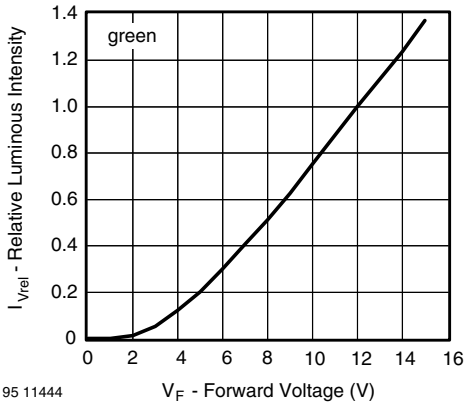

Figure 22. Relative Luminous Intensity vs. Forward Voltage

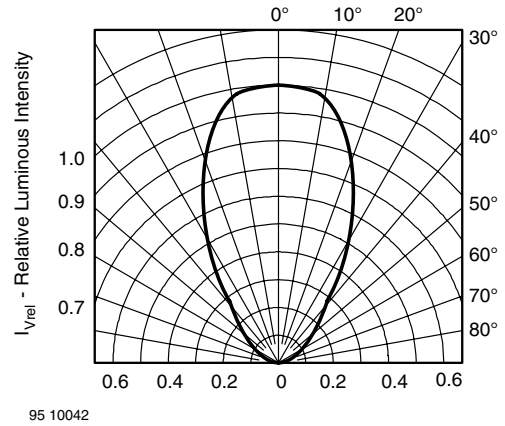

Figure 25. Rel. Luminous Intensity vs. Angular Displacement

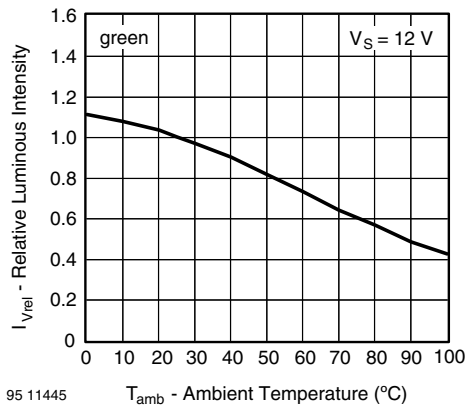

Figure 23. Rel. Luminous Intensity vs. Ambient Temperature

TLRG4420CU, TLRH4420CU, TLRO4420CU, TLR4420CU

Vishay Semiconductors



PACKAGE DIMENSIONS in millimeters

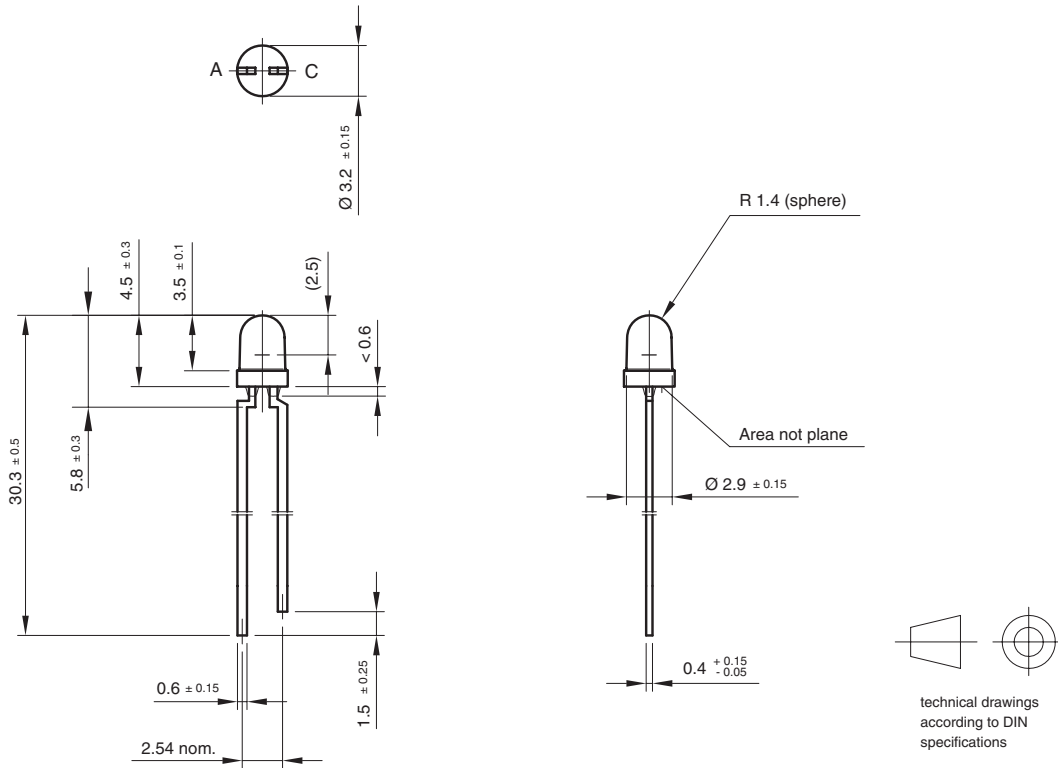

Drawing-No.: 6.544-5255.01-4
Issue: 7; 25.09.08
95 10913



Disclaimer

ALL PRODUCT, PRODUCT SPECIFICATIONS AND DATA ARE SUBJECT TO CHANGE WITHOUT NOTICE TO IMPROVE RELIABILITY, FUNCTION OR DESIGN OR OTHERWISE.

Vishay Intertechnology, Inc., its affiliates, agents, and employees, and all persons acting on its or their behalf (collectively, "Vishay"), disclaim any and all liability for any errors, inaccuracies or incompleteness contained in any datasheet or in any other disclosure relating to any product.

Vishay makes no warranty, representation or guarantee regarding the suitability of the products for any particular purpose or the continuing production of any product. To the maximum extent permitted by applicable law, Vishay disclaims (i) any and all liability arising out of the application or use of any product, (ii) any and all liability, including without limitation special, consequential or incidental damages, and (iii) any and all implied warranties, including warranties of fitness for particular purpose, non-infringement and merchantability.

Statements regarding the suitability of products for certain types of applications are based on Vishay's knowledge of typical requirements that are often placed on Vishay products in generic applications. Such statements are not binding statements about the suitability of products for a particular application. It is the customer's responsibility to validate that a particular product with the properties described in the product specification is suitable for use in a particular application. Parameters provided in datasheets and/or specifications may vary in different applications and performance may vary over time. All operating parameters, including typical parameters, must be validated for each customer application by the customer's technical experts. Product specifications do not expand or otherwise modify Vishay's terms and conditions of purchase, including but not limited to the warranty expressed therein.

Except as expressly indicated in writing, Vishay products are not designed for use in medical, life-saving, or life-sustaining applications or for any other application in which the failure of the Vishay product could result in personal injury or death. Customers using or selling Vishay products not expressly indicated for use in such applications do so at their own risk and agree to fully indemnify and hold Vishay and its distributors harmless from and against any and all claims, liabilities, expenses and damages arising or resulting in connection with such use or sale, including attorneys fees, even if such claim alleges that Vishay or its distributor was negligent regarding the design or manufacture of the part. Please contact authorized Vishay personnel to obtain written terms and conditions regarding products designed for such applications.

No license, express or implied, by estoppel or otherwise, to any intellectual property rights is granted by this document or by any conduct of Vishay. Product names and markings noted herein may be trademarks of their respective owners.