

High Intensity LED, \varnothing 5 mm Tinted Diffused Package

Description

This device has been designed to meet the increasing demand for extremely bright yellow LEDs. It is housed in a 5 mm untinted non-diffused plastic package. Despite of the wide viewing angle this device provides a very high luminous intensity.

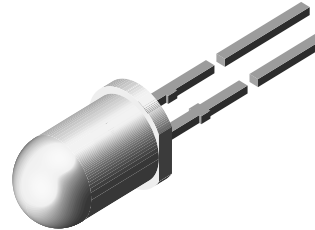

19223



Features

- AllnGaP technology
- Standard T-1 $\frac{3}{4}$ package
- Small mechanical tolerances
- Suitable for DC and high peak current
- Wide viewing angle
- Very high intensity
- Luminous intensity categorized
- Lead-free device

OFF / ON indicator
 Lightpipe
 Outdoor display
 Medical instruments
 Maintenance lights
 Legend lights

Applications

Status lights

Parts Table

Part	Color, Luminous Intensity	Angle of Half Intensity ($\pm\phi$)	Technology
TLHE5400	Yellow, $I_V > 16$ mcd	30 °	AllnGaP on GaAs

Absolute Maximum Ratings

$T_{amb} = 25$ °C, unless otherwise specified

TLHE5400

Parameter	Test condition	Symbol	Value	Unit
Reverse voltage		V_R	5	V
DC Forward current	$T_{amb} \leq 65$ °C	I_F	30	mA
Surge forward current	$t_p \leq 10$ μ s	I_{FSM}	0.1	A
Power dissipation	$T_{amb} \leq 65$ °C	P_V	80	mW
Junction temperature		T_j	100	°C
Operating temperature range		T_{amb}	- 40 to + 100	°C
Storage temperature range		T_{stg}	- 55 to + 100	°C
Soldering temperature	$t \leq 5$ s, 2 mm from body	T_{sd}	260	°C
Thermal resistance junction/ambient		R_{thJA}	350	K/W

Optical and Electrical Characteristics

$T_{amb} = 25\text{ }^{\circ}\text{C}$, unless otherwise specified

Yellow

TLHE5400

Parameter	Test condition	Symbol	Min	Typ.	Max	Unit
Luminous intensity ¹⁾	$I_F = 10\text{ mA}$	I_V	16	60		mcd
Dominant wavelength	$I_F = 10\text{ mA}$	λ_d	581	588	594	nm
Peak wavelength	$I_F = 10\text{ mA}$	λ_p		590		nm
Angle of half intensity	$I_F = 10\text{ mA}$	ϕ		± 30		deg
Forward voltage	$I_F = 20\text{ mA}$	V_F		2	2.6	V
Reverse voltage	$I_R = 10\text{ }\mu\text{A}$	V_R	5			V
Junction capacitance	$V_R = 0, f = 1\text{ MHz}$	C_j		15		pF

¹⁾ in one Packing Unit $I_{Vmin}/I_{Vmax} \leq 0.5$

Typical Characteristics ($T_{amb} = 25\text{ }^{\circ}\text{C}$ unless otherwise specified)

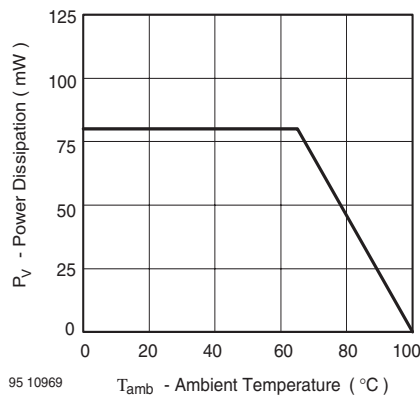

Figure 1. Power Dissipation vs. Ambient Temperature

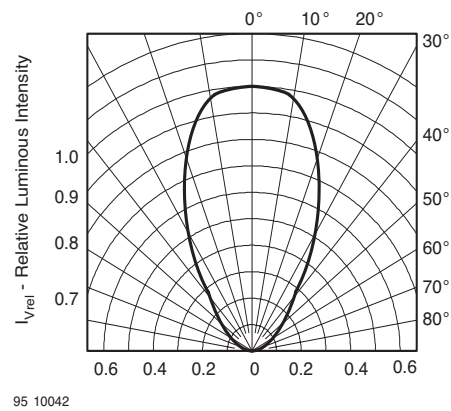

Figure 3. Rel. Luminous Intensity vs. Angular Displacement

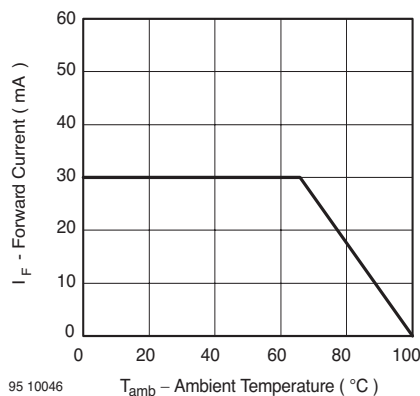

Figure 2. Forward Current vs. Ambient Temperature

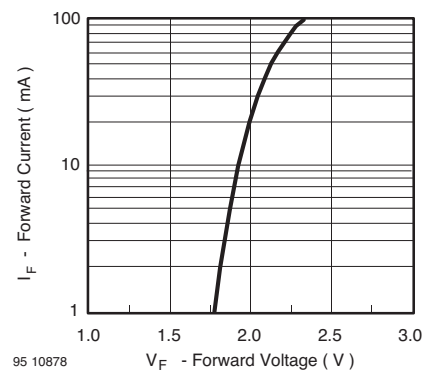

Figure 4. Forward Current vs. Forward Voltage

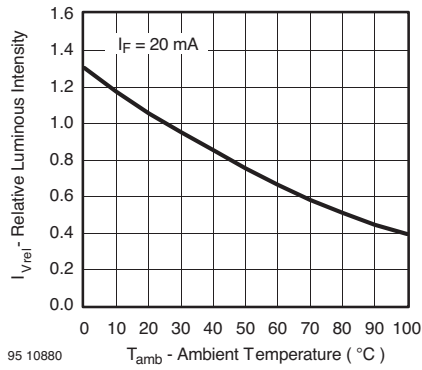

Figure 5. Rel. Luminous Intensity vs. Ambient Temperature

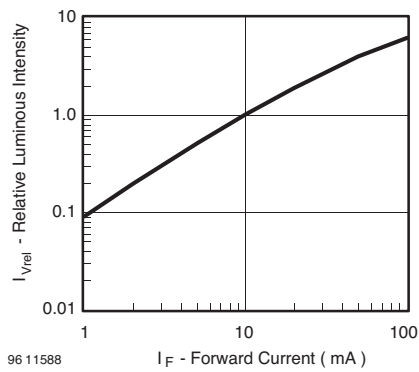

Figure 6. Relative Luminous Intensity vs. Forward Current

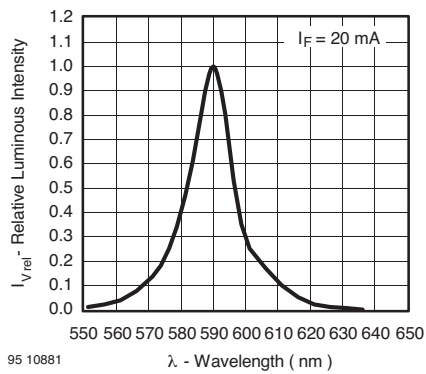
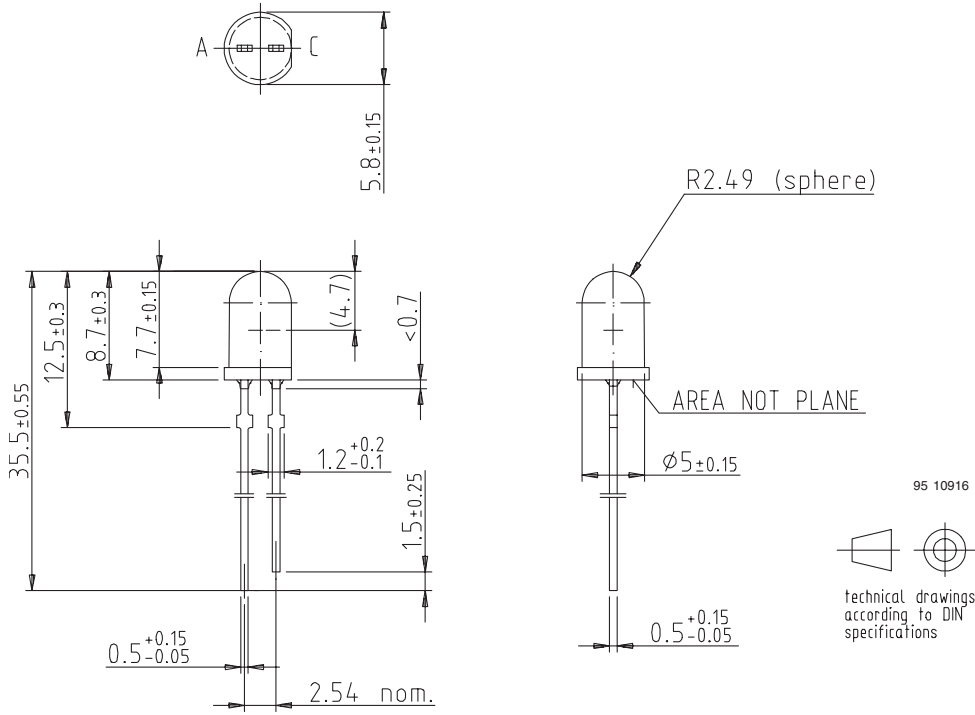

Figure 7. Relative Intensity vs. Wavelength

Package Dimensions in mm



Ozone Depleting Substances Policy Statement

It is the policy of **Vishay Semiconductor GmbH** to

1. Meet all present and future national and international statutory requirements.
2. Regularly and continuously improve the performance of our products, processes, distribution and operating systems with respect to their impact on the health and safety of our employees and the public, as well as their impact on the environment.

It is particular concern to control or eliminate releases of those substances into the atmosphere which are known as ozone depleting substances (ODSs).

The Montreal Protocol (1987) and its London Amendments (1990) intend to severely restrict the use of ODSs and forbid their use within the next ten years. Various national and international initiatives are pressing for an earlier ban on these substances.

Vishay Semiconductor GmbH has been able to use its policy of continuous improvements to eliminate the use of ODSs listed in the following documents.

1. Annex A, B and list of transitional substances of the Montreal Protocol and the London Amendments respectively
2. Class I and II ozone depleting substances in the Clean Air Act Amendments of 1990 by the Environmental Protection Agency (EPA) in the USA
3. Council Decision 88/540/EEC and 91/690/EEC Annex A, B and C (transitional substances) respectively.

Vishay Semiconductor GmbH can certify that our semiconductors are not manufactured with ozone depleting substances and do not contain such substances.

**We reserve the right to make changes to improve technical design
and may do so without further notice.**

Parameters can vary in different applications. All operating parameters must be validated for each customer application by the customer. Should the buyer use Vishay Semiconductors products for any unintended or unauthorized application, the buyer shall indemnify Vishay Semiconductors against all claims, costs, damages, and expenses, arising out of, directly or indirectly, any claim of personal damage, injury or death associated with such unintended or unauthorized use.

Vishay Semiconductor GmbH, P.O.B. 3535, D-74025 Heilbronn, Germany
Telephone: 49 (0)7131 67 2831, Fax number: 49 (0)7131 67 2423



Notice

Specifications of the products displayed herein are subject to change without notice. Vishay Intertechnology, Inc., or anyone on its behalf, assumes no responsibility or liability for any errors or inaccuracies.

Information contained herein is intended to provide a product description only. No license, express or implied, by estoppel or otherwise, to any intellectual property rights is granted by this document. Except as provided in Vishay's terms and conditions of sale for such products, Vishay assumes no liability whatsoever, and disclaims any express or implied warranty, relating to sale and/or use of Vishay products including liability or warranties relating to fitness for a particular purpose, merchantability, or infringement of any patent, copyright, or other intellectual property right.

The products shown herein are not designed for use in medical, life-saving, or life-sustaining applications. Customers using or selling these products for use in such applications do so at their own risk and agree to fully indemnify Vishay for any damages resulting from such improper use or sale.