

# Cylindrical High-Intensity Blue LED (5 mm)

## OVLLB8C7

- Wide viewing angle
- High-brightness indicator
- Industry standard lead spacing
- Unique lens shape for flexible applications

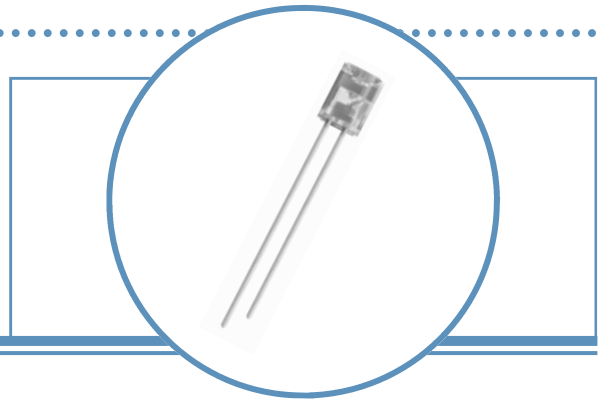

The **OVLLB8C7** is designed for superior performance in signage and lighting applications that require wide-angle, uniform light output. This device combines a high-intensity InGaN LED with a unique flat-topped T-1<sup>3</sup>/<sub>4</sub> package to provide both high brightness and a wide spatial radiation pattern.

### Applications

- Channel letter and other signage backlighting
- Decorative architectural indoor and outdoor lighting accents
- Industrial and consumer indicators

| Part Number | Material | Emitted Color | Intensity Typ. mcd | Lens Color  |
|-------------|----------|---------------|--------------------|-------------|
| OVLLB8C7    | InGaN    | Blue          | 300                | Water Clear |

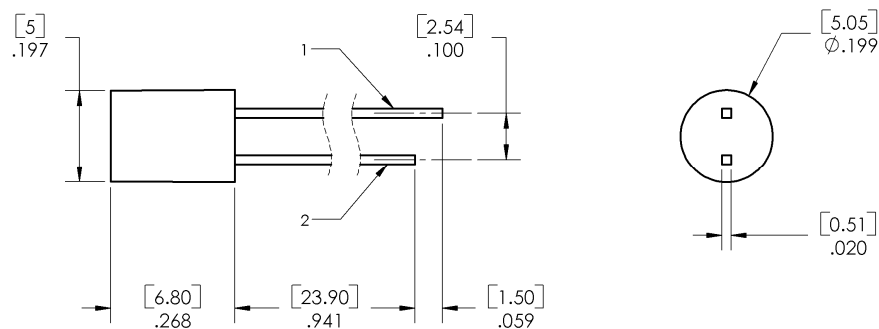

1 ANODE 2 CATHODE DIMENSIONS ARE IN INCHES AND [MILLIMETERS].



**DO NOT LOOK DIRECTLY  
AT LED WITH UNSHIELDED  
EYES OR DAMAGE TO  
RETINA MAY OCCUR.**

OPTEK reserves the right to make changes at any time in order to improve design and to supply the best product possible.

# Cylindrical High-Intensity Blue LED

## OVLLB8C7

### Absolute Maximum Ratings

$T_A = 25^\circ\text{C}$  unless otherwise noted

|  |              |
|--|--------------|
| Storage Temperature Range  | -40 ~ +100°C |
| Operating Temperature Range  | -40 ~ +85°C  |
| Reverse Voltage  | 5 V          |
| Continuous Forward Current   | 20 mA        |
| Peak Forward Current (10% Duty Cycle, 1 KHz)                                   | 50 mA        |
| Power Dissipation  | 80 mW        |
| Lead Soldering Temperature (4 mm from the base of the epoxy bulb) <sup>1</sup> | 260°C        |
| LED Junction Temperature   | 125°C        |
| Current Linearity vs. Ambient Temperature                                      | -0.2 mA/°C   |

Note:

- Solder time less than 5 seconds at temperature extreme.

### Electrical Characteristics

$T_A = 25^\circ\text{C}$  unless otherwise noted

| SYMBOL             | PARAMETER           | MIN  | TYP  | MAX  | UNITS         | CONDITIONS           |
|--------------------|---------------------|------|------|------|---------------|----------------------|
| $I_V$              | Luminous Intensity  | 170  | 300  | ---- | mcd           | $I_F = 20\text{ mA}$ |
| $V_F$              | Forward Voltage     | ---- | 3.4  | 4.0  | V             | $I_F = 20\text{ mA}$ |
| $I_R$              | Reverse Current     | ---- | ---- | 50   | $\mu\text{A}$ | $V_R = 5\text{ V}$   |
| $\lambda_P$        | Peak Wavelength     | ---- | 466  | ---- | nm            | $I_F = 20\text{ mA}$ |
| $\lambda_D$        | Dominant Wavelength | ---- | 470  | ---- | nm            | $I_F = 20\text{ mA}$ |
| $2\Theta_{1/2H-H}$ | 50% Power Angle     | ---- | 85   | ---- | deg           | $I_F = 20\text{ mA}$ |

### Standard Bins ( $I_F = 20\text{ mA}$ )

Lamps are sorted to luminous intensity ( $I_V$ ) and dominant wavelength ( $\lambda_D$ ) bins shown. Orders for OVLLB8C7 may be filled with any or all bins contained as below.

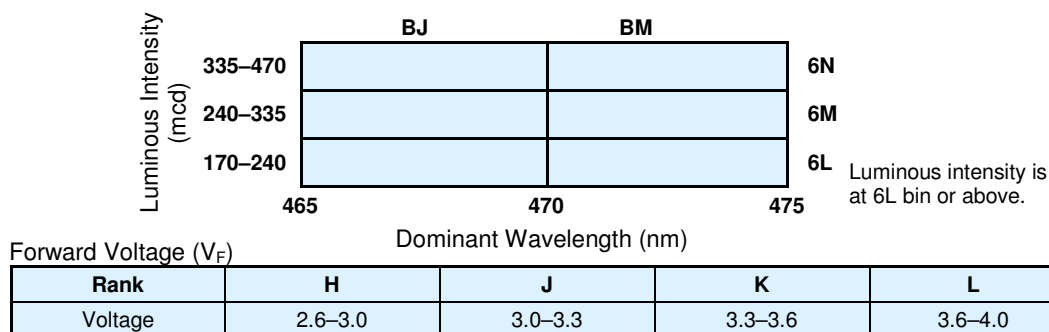

Notes:

- All ranks will be included per delivery, rank ratio will be based on the chip distribution.
- To designate luminous intensity ranks, please contact OPTeK.
- Pb content <1000 PPM.

### Beam Pattern

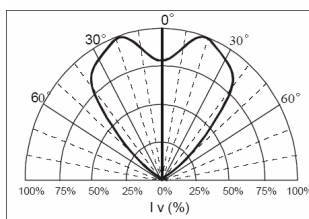

OPTeK reserves the right to make changes at any time in order to improve design and to supply the best product possible.

### Typical Electro-Optical Characteristics Curves

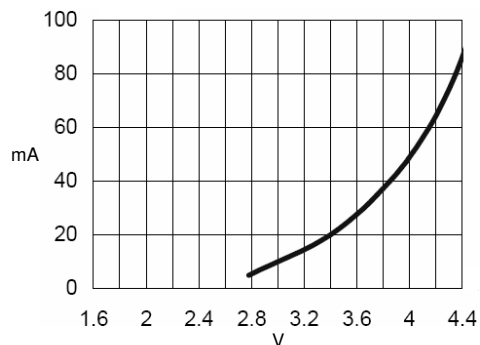

Forward Current vs Forward Voltage

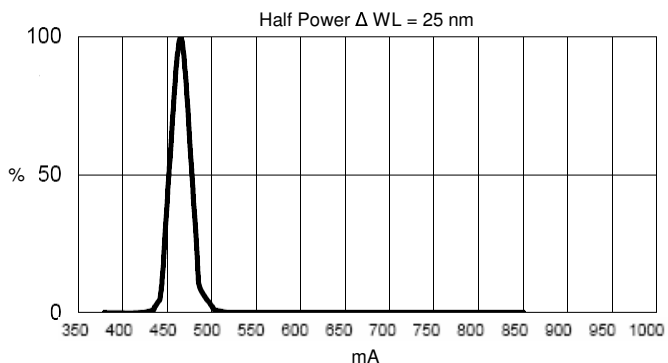

Relative Luminous Intensity vs Wavelength

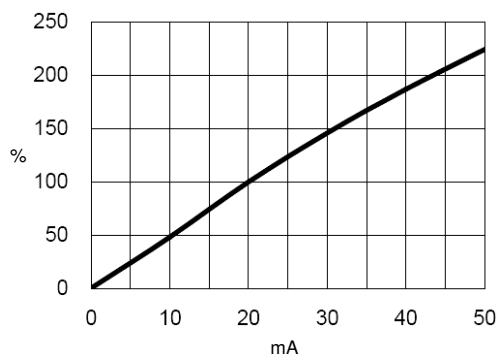

Relative Luminous Intensity vs Forward Current

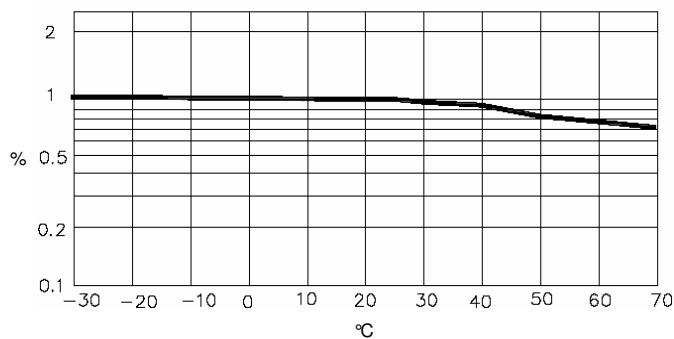

Relative Luminous Intensity vs Ambient Temperature

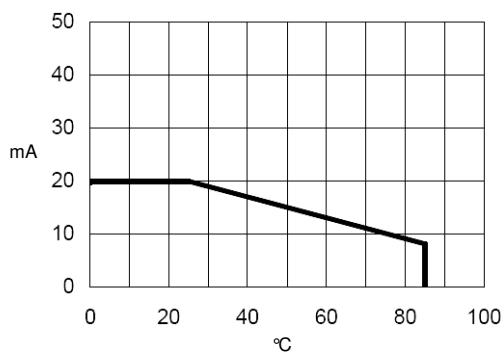

Forward Current vs Ambient Temperature

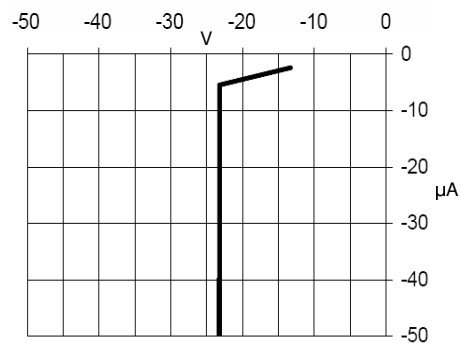

Reverse Current vs Reverse Voltage

OPTEK reserves the right to make changes at any time in order to improve design and to supply the best product possible.

# Cylindrical High-Intensity Blue LED OVLLB8C7

Packing Information: Available in bulk or reel

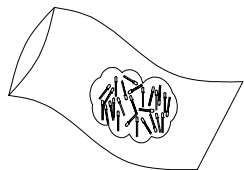

Bulk: 500 pcs/bag

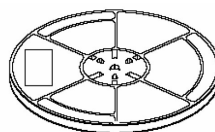

13-inch reel: 2000 pcs/reel

Carrier Tape Dimensions: Loaded quantity 2000 pieces per reel

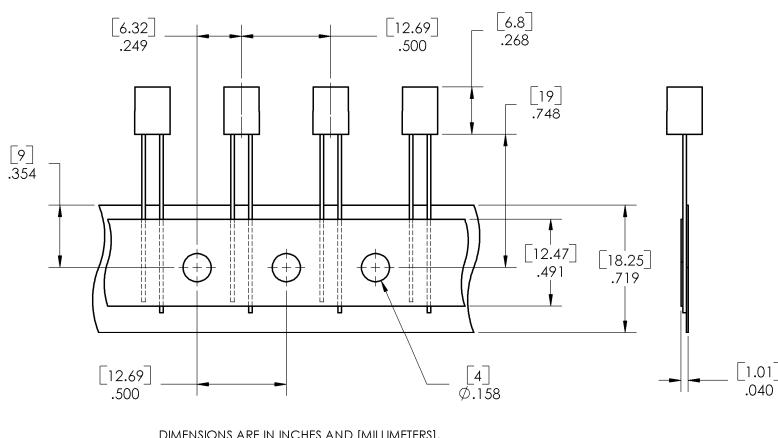

## Moisture Resistant Packaging

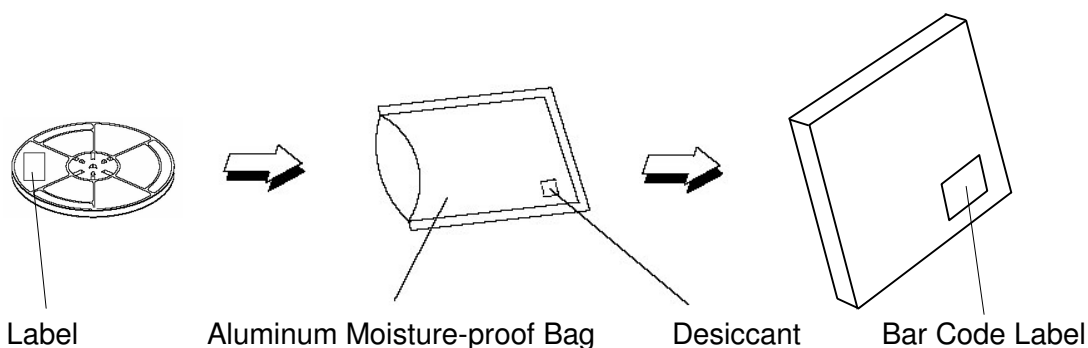

OPTEK reserves the right to make changes at any time in order to improve design and to supply the best product possible.