



SPC
TECHNOLOGY

ALL RIGHTS RESERVED. NO PORTION OF THIS PUBLICATION, WHETHER IN WHOLE OR IN PART CAN BE REPRODUCED WITHOUT THE EXPRESS WRITTEN CONSENT OF SPC TECHNOLOGY.

SPC-F005JLVG

REVISIONS		DOC. NO.	SPC-F005	Effective	7/8/02	DCP No	1398	
DCP #	REV	DESCRIPTION	DRAWN	DATE	CHECKD	DATE	APPRVI	DATE
XX	XX	XXXX	XXXX	10-09-08	XXXX	10-09-08	XXXX	10-09-08
XXXX	XXXX		XXXX	10-09-08	XXXX	10-09-08	XXXX	10-09-08

Package Outlines

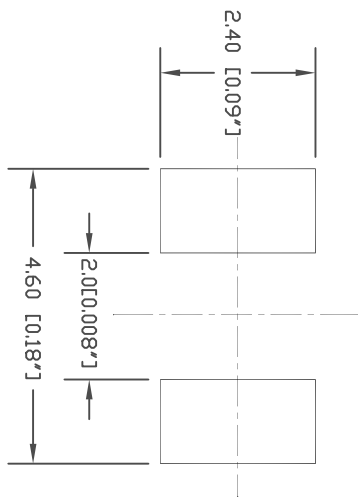
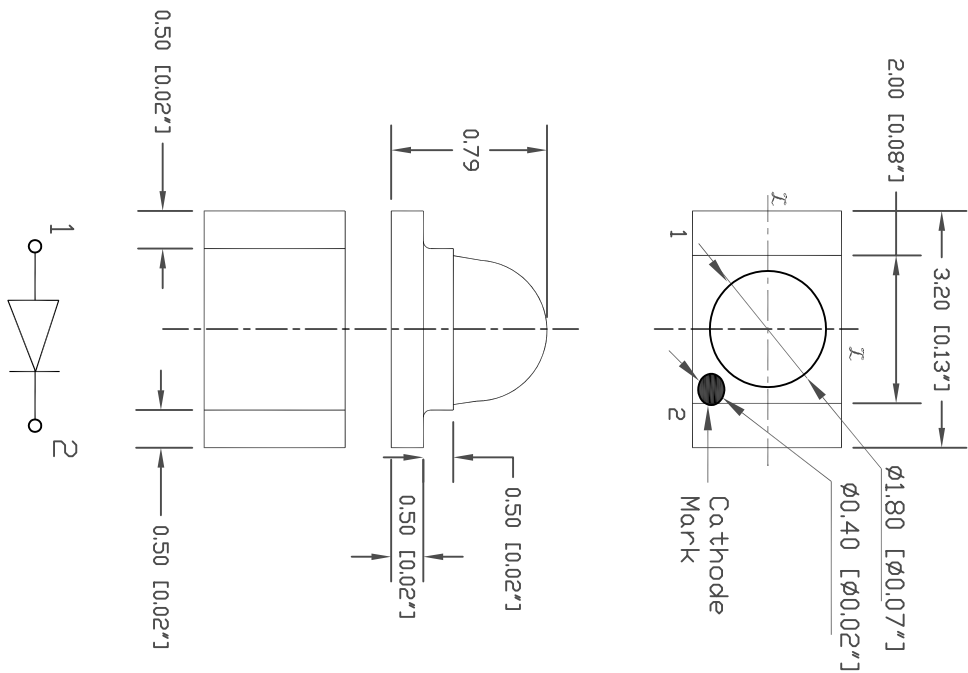

ITEM	MATERIALS
Resin (mold)	Epoxy
Bonding Wire	$\phi 25 \mu\text{m Au}$
Lens color	Water Clear
Printed circuit board	BT (white)
Dice	InGaN/SiC
Emitted color	green

NOTES

- All dimensions are in millimeters (inches);
- Tolerances are $\pm 0.1\text{mm}$ (0.004inch) unless otherwise noted.

ATTENTION

Observe Precautions For Handling Electrostatic Sensitive Devices

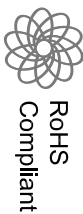

RoHS
Compliant

DISCLAIMER:
ALL STATEMENTS AND TECHNICAL INFORMATION CONTAINED HEREIN ARE BASED UPON INFORMATION AND/OR TESTS WE BELIEVE TO BE ACCURATE AND RELIABLE. SINCE CONDITIONS OF USE ARE BEYOND OUR CONTROL, THE USER SHALL DETERMINE THE SUITABILITY OF THE PRODUCT FOR THE INTENDED USE AND ASSUME ALL RISK AND LIABILITY WHATSOEVER IN CONNECTION THEREWITH.

TOLERANCES:

UNLESS OTHERWISE SPECIFIED, DIMENSIONS ARE FOR REFERENCE PURPOSES ONLY.

DRAWN BY:	DATE:
XXXX	10-09-08
CHECKED BY:	DATE:
XXXX	10-09-08
APPROVED BY:	DATE:
XXXX	10-09-08

DRAWING TITLE:		SCALE:	U.D.M.	SHEET:	DF
Multi-Color LED		NTS	INCHES [mm]	1	1
SIZE	DWG. NO.	ELECTRONIC FILE	REV		
A	MC24148	02P5943	XX		



SPC
TECHNOLOGY

ALL RIGHTS RESERVED. NO PORTION OF THIS PUBLICATION, WHETHER IN WHOLE OR IN PART CAN BE REPRODUCED WITHOUT THE EXPRESS WRITTEN CONSENT OF SPC TECHNOLOGY.

SPC-F005.DWG

REVISONS		DOC. NO.	SPC-F005	*	Effective	7/8/02	*	Doc No	1398
DCP #	REV	DESCRIPTION	DRAWN	DATE	CHECKD	DATE	APPRVI	DATE	
XX	XX	XXXX	XXXX	09-09-08	XXXX	09-09-08	XXXX	09-09-08	
XXXX	XXXX		XXXX	09-09-08	XXXX	09-09-08	XXXX	09-09-08	

Absolute Maximum Ratings

(TA=25°C)

Parameter	Symbol	Value	Unit
Forward current	If	30	mA
Reverse voltage	Vr	5	V
Power dissipation	Pd	120	mW
Operating temperature range	Top	-20~+80	°C
Storage temperature range	Tstg	-40~+100	°C
Peak pulsing current (1/8 duty f=1kHz)	Ifp	125	mA

Electro-optical Characteristics

(TA=25°C)

Parameter	Test Condition	Symbol	Value		Unit	
			Min	Typ		Max
Wavelength at peak emission	If=20mA	λ_{peak}	500	510	515	Nm
Spectral half bandwidth	If=20mA	$\Delta\lambda$	--	20	--	Nm
Dominant wavelength	If=20mA	λ_{dom}	--	505	--	Nm
Forward voltage	If=20mA	Vf	--	3.5	4.0	V
Luminous intensity	If=20mA	Iv	--	900	--	mcd
Viewing angle at 50% Iv	If=10mA	2 θ 1/2	--	20	--	deg
Reverse current	Vr=5V	Ir	--	--	10	μ A



RoHS
Compliant

DISCLAIMER:
ALL STATEMENTS AND TECHNICAL INFORMATION CONTAINED HEREIN ARE BASED UPON INFORMATION AND/OR TESTS WE BELIEVE TO BE ACCURATE AND RELIABLE. SINCE CONDITIONS OF USE ARE BEYOND OUR CONTROL, THE USER SHALL DETERMINE THE SUITABILITY OF THE PRODUCT FOR THE INTENDED USE AND ASSUME ALL RISK AND LIABILITY WHATSOEVER IN CONNECTION THEREWITH.

TOLERANCES:

UNLESS OTHERWISE SPECIFIED, DIMENSIONS ARE FOR REFERENCE PURPOSES ONLY.

DRAWN BY:	DATE:
XXXX	09-09-08
CHECKED BY:	DATE:
XXXX	09-09-08
APPROVED BY:	DATE:
XXXX	09-09-08

DRAWING TITLE:

Multi-Color LED

SIZE	DWG. NO.	ELECTRONIC FILE	REV
A	MC24148	02P5943	XX
SCALE:	NTS	U.D.M.: INCHES [mm]	SHEET: 1 OF



SPC
TECHNOLOGY

ALL RIGHTS RESERVED. NO PORTION OF THIS PUBLICATION, WHETHER IN WHOLE OR IN PART CAN BE REPRODUCED WITHOUT THE EXPRESS WRITTEN CONSENT OF SPC TECHNOLOGY.
SPC-F005.DWG

REVISIONS		DOC. NO.	SPC-F005	*	Effective	7/8/02	*	Doc No	1398
DCP #	REV	DESCRIPTION	DRAWN	DATE	CHECKD	DATE	APPRV	DATE	
XX	XX	XXXX	XXXX	16-09-08	XXXX	16-09-08	XXXX	16-09-08	
XXXX	XXXX		XXXX	16-09-08	XXXX	16-09-08	XXXX	16-09-08	

OPTICAL CHARACTERISTIC CURVES

Relative Intensity vs. Wavelength

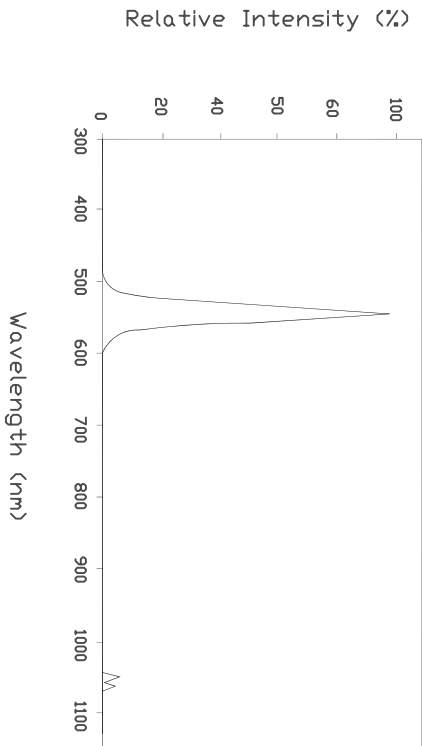

Forward Current vs. Forward Voltage

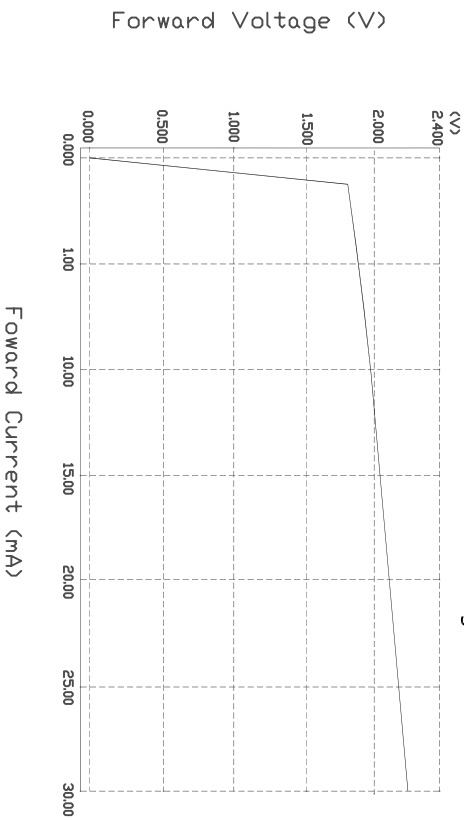

Directive Characteristics

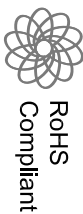
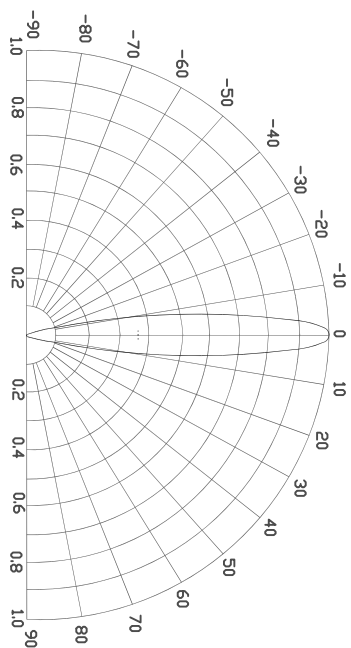

DISCLAIMER:
ALL STATEMENTS AND TECHNICAL INFORMATION CONTAINED HEREIN ARE BASED UPON INFORMATION AND/OR TESTS WE BELIEVE TO BE ACCURATE AND RELIABLE. SINCE CONDITIONS OF USE ARE BEYOND OUR CONTROL, THE USER SHALL DETERMINE THE SUITABILITY OF THE PRODUCT FOR THE INTENDED USE AND ASSUME ALL RISK AND LIABILITY WHATSOEVER IN CONNECTION THEREWITH.

TOLERANCES:

UNLESS OTHERWISE SPECIFIED, DIMENSIONS ARE FOR REFERENCE PURPOSES ONLY.

DRAWN BY:	XXXX	DATE:	16-09-08
CHECKED BY:	XXXX	DATE:	16-09-08
APPROVED BY:	XXXX	DATE:	16-09-08

DRAWING TITLE:

Multi - Color LED

SIZE	DWG. NO.	ELECTRONIC FILE	REV
A	MC24148	02P5943	XX
SCALE:	NTS	U.D.M:	INCHES [mm]
SHEET:	1	OF	1



SPC
TECHNOLOGY

ALL RIGHTS RESERVED. NO PORTION OF THIS PUBLICATION, WHETHER IN WHOLE OR IN PART CAN BE REPRODUCED WITHOUT THE EXPRESS WRITTEN CONSENT OF SPC TECHNOLOGY.
SPC-F005.DWG

REVISONS		DOC. NO.	SPC-F005	*	Effective	7/8/02	*	Doc No	1398
DOP #	REV	DESCRIPTION	DRAWN	DATE	CHECKD	DATE	APPRVI	DATE	
XX	XX	XXXX	XXXX	24-09-08	XXXX	24-09-08	XXXX	24-09-08	
XXXX	XXXX		XXXX	24-09-08	XXXX	24-09-08	XXXX	24-09-08	

• Reflow Temp/Time

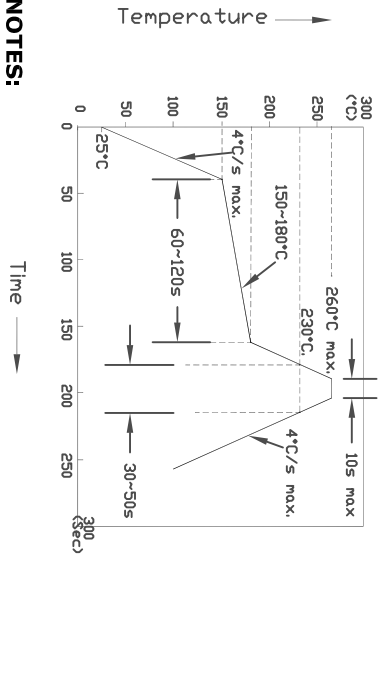

NOTES:

1. We recommend the reflow temperatures 245°C (±5°C), the maximum soldering temperature should be limited to 260°C. It don't cause stress to the epoxy resin while it is exposed to high temperature.
2. Number of reflow process shall be 2 times or less.

■ Soldering Iron

Basic Spec is ≤ 5 sec when 260°C. If temperature is higher, time should be shorter (+10°C \rightarrow -1sec). Power dissipation of iron should be smaller than 15W and Temperature should be controllable. Surface temperature of the device should be under 230°C.

■ Rework

1. Customer must finish rework within 5 sec under 260°C.
2. The head of iron can not touch copper foil
3. Twin-head type is preferred.

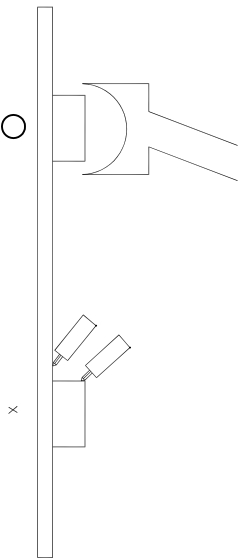

■ Test Circuit

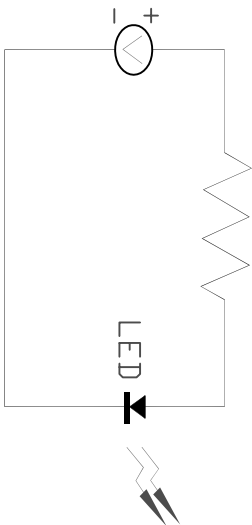

■ Handling Precautions

1. Over-current-proof

Customer must apply resistors for protection; otherwise slight voltage shift will cause big current change (Burn out will happen).

2. Storage

2.1 It is recommended to store the products in the following conditions:

Humidity: 60% RH, Max.
Temperature: 5°C~30°C (41°F~86°F)

2.2 Shelf life in sealed bag: 12 month at <5°C~30°C and <30% RH, after the package is opened, the products should be used within a week or they should be keeping to stored at ≤ 20 RH, with zip-lock sealed.

3. Baking

It is recommended to baking before soldering when the pack is unsealed after 72hrs. The Conditions are as followings:

- 3.1 60±3°C x(12~24hrs) and <5%RH, taped reel type
- 3.2 100±3°C x(45min~1hr), bulk type
- 3.3 130±3°C x(15~30min), bulk type



TOLERANCES:

DISCLAIMER:
ALL STATEMENTS AND TECHNICAL INFORMATION CONTAINED HEREIN ARE BASED UPON INFORMATION AND/OR TESTS WE BELIEVE TO BE ACCURATE AND RELIABLE. SINCE CONDITIONS OF USE ARE BEYOND OUR CONTROL, THE USER SHALL DETERMINE THE SUITABILITY OF THE PRODUCT FOR THE INTENDED USE AND ASSUME ALL RISK AND LIABILITY WHATSOEVER IN CONNECTION THEREWITH.

UNLESS OTHERWISE SPECIFIED, DIMENSIONS ARE FOR REFERENCE PURPOSES ONLY.

DRAWN BY:	XXXX	DATE:	24-09-08
CHECKED BY:	XXXX	DATE:	24-09-08
APPROVED BY:	XXXX	DATE:	24-09-08

DRAWING TITLE:		Multi Color LED	
SIZE	DWG. NO.	ELECTRONIC FILE	REV
A	MC24148	02P5943	XX
SCALE:	NTS	U.D.M:	INCHES [mm]
		SHEET:	1 OF



SPC
TECHNOLOGY

ALL RIGHTS RESERVED. NO PORTION OF THIS PUBLICATION, WHETHER IN WHOLE OR IN PART CAN BE REPRODUCED WITHOUT THE EXPRESS WRITTEN CONSENT OF SPC TECHNOLOGY.

SPC-F005.DWG

REVISONS		DOC. NO.	SPC-F005	*	Effective	7/8/02	*	DCP No	1398
DCP #	REV	DESCRIPTION	DRAWN	DATE	CHECKD	DATE	APPRVI	DATE	
XX	XX	XXXX	XXXX	24-09-08	XXXX	24-09-08	XXXX	24-09-08	
XXXX	XXXX		XXXX	24-09-08	XXXX	24-09-08	XXXX	24-09-08	

SMD Chip LED Lamps Packaging Specifications

Feeding Direction

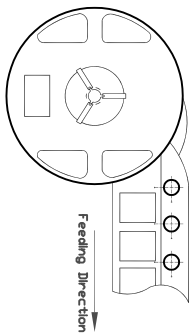

Dimensions of Reel (Unit: mm)

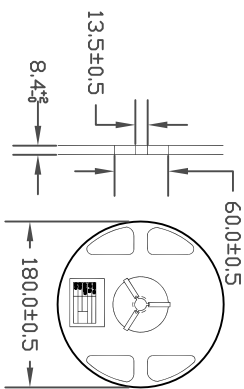

Arrangement of Tape

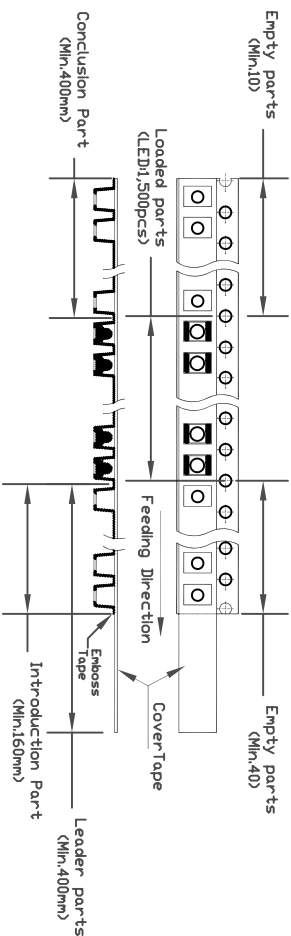

Dimensions of Tape (Unit: mm)

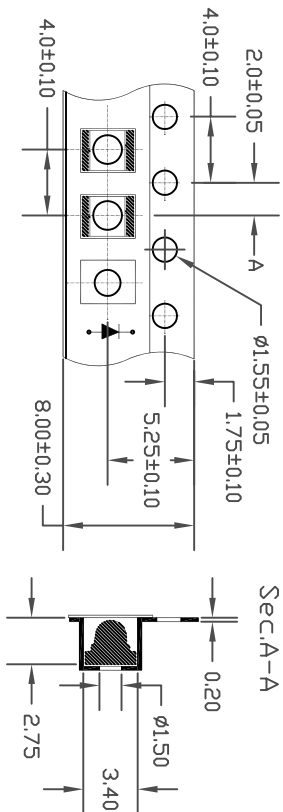

- NOTES:
1. Empty component pockets are sealed with top cover tape!
 2. The maximum number of missing lamps is two!
 3. The cathode is oriented towards the tape sprocket hole in accordance with ANSI/EIA RS-481 specifications.
 4. 1,500 pcs/Reel



RoHS
Compliant

DISCLAIMER:

ALL STATEMENTS AND TECHNICAL INFORMATION CONTAINED HEREIN ARE BASED UPON INFORMATION AND/OR TESTS WE BELIEVE TO BE ACCURATE AND RELIABLE. SINCE CONDITIONS OF USE ARE BEYOND OUR CONTROL, THE USER SHALL DETERMINE THE SUITABILITY OF THE PRODUCT FOR THE INTENDED USE AND ASSUME ALL RISK AND LIABILITY WHATSOEVER IN CONNECTION THEREWITH.

TOLERANCES:

UNLESS OTHERWISE SPECIFIED, DIMENSIONS ARE FOR REFERENCE PURPOSES ONLY.

DRAWN BY:	DATE:	DRAWING TITLE:		Multi Color LED	
XXXX	24-09-08	SIZE	DWG. NO.	ELECTRONIC FILE	REV
CHECKED BY:	DATE:	A	MC24148	02P5943	XX
XXXX	24-09-08	SCALE:	NTS	U.D.M.: INCHES [mm]	SHEET: 1 OF 1
APPROVED BY:	DATE:				
XXXX	24-09-08				