



ALL RIGHTS RESERVED. NO PORTION OF THIS PUBLICATION, WHETHER IN WHOLE OR IN PART, CAN BE REPRODUCED WITHOUT THE EXPRESS WRITTEN CONSENT OF SPC TECHNOLOGY.

SPC-F006.DWG

REVISIONS

DOC. NO. SPC-F005 * Effective: 7/8/02 * DCP No: 1308

| DCP # | REV | DESCRIPTION | DRAWN | DATE | CHECKD | DATE | APPRVD | DATE |
|-------|-----|-------------|-------|----------|--------|----------|--------|----------|
| 1908 | A | RELEASED | EO | 6/7/06 | YA | 6/19/06 | HO | 6/19/06 |
| 1908 | B | Flat Remove | JN | 07/31/08 | JWM | 07/31/08 | JWM | 07/31/08 |



RoHS Compliant

Features:

- High intensity
- Standard T-1 diameter package
- General purpose LED
- Reliable and rugged
- With resistor built-in

Specifications:

- Lead spacing is measured where the leads emerge from the package

| Source Color | Chlp Material | Lens Color |
|--------------|---------------|--------------|
| Red | GaAsP | Red Diffused |

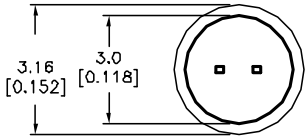

Absolute Maximum Rating at Ta=25°C

| Parameter | MAX. | Unit |
|---|---------------------|-------|
| Power Dissipation | 80 | mW |
| Peak Forward Current (1/10 Duty Cycle, 0.1ms Pulse Width) | 100 | mA |
| Continuous Forward Current | 30 | mA |
| Derating Linear From 50°C | 0.4 | mA/°C |
| Reverse Voltage | 5 | V |
| Operating Temperature Range | -25°C to +80°C | |
| Storage Temperature Range | -40°C to +100°C | |
| Lead Soldering Temperature [4mm (0.157) From Body] | 260°C for 5 seconds | |

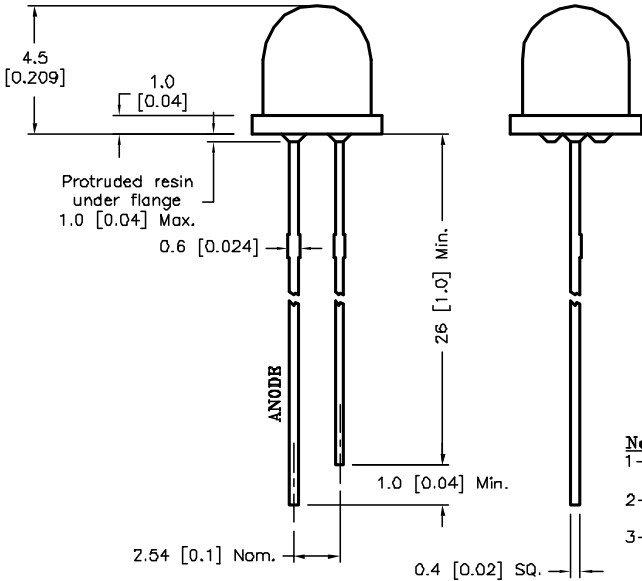

Electrical Optical Characteristics at Ta=25°C

| Parameter | Symbol | Min. | Typ. | Max | Unit | Test Condition |
|--------------------------|-----------------|------|------|-----|---------|---------------------|
| Luminous Intensity | I_v | | 30 | | mcd | $I_f=20mA$ (Note 1) |
| Viewing Angle | $2\theta_{1/2}$ | | 60 | | Deg | (Note 2) |
| Peak Emission Wavelength | λ_p | | 660 | | nm | $I_f=20mA$ |
| Dominant Wavelength | λ_d | | 645 | | nm | $I_f=20mA$ (Note 3) |
| Spectral Line Half-Width | $\Delta\lambda$ | | 25 | | nm | $I_f=20mA$ |
| Forward Voltage | V_f | | 1.9 | 2.5 | V | $I_f=20mA$ |
| Reverse Current | I_r | --- | --- | 100 | μA | $V_R=5V$ |

Notes:

- 1- Luminous intensity is measured with a light sensor and filter combination that approximates the CIE eye-response curve.
- 2- $\theta_{1/2}$ is the off-axis angle at which the luminous intensity is half the axial luminous intensity
- 3- The dominant wavelength (λ_d) is derived from the CIE chromaticity diagram and represents the single wavelength which defines the color of the device.

DISCLAIMER:
ALL STATEMENTS AND TECHNICAL INFORMATION CONTAINED HEREIN ARE BASED UPON INFORMATION AND/OR TESTS WE BELIEVE TO BE ACCURATE AND RELIABLE. SINCE CONDITIONS OF USE ARE BEYOND OUR CONTROL, THE USER SHALL DETERMINE THE SUITABILITY OF THE PRODUCT FOR THE INTENDED USE AND ASSUME ALL RISK AND LIABILITY WHATSOEVER IN CONNECTION THEREWITH.

TOLERANCES:

UNLESS OTHERWISE SPECIFIED,
 ± 0.25 [± 0.010]

| | |
|-----------------|---------|
| DRAWN BY: | DATE: |
| EKLAS ODISH | 6/7/06 |
| CHECKED BY: | DATE: |
| YILMAZ AKYONDEM | 6/19/06 |
| APPROVED BY: | DATE: |
| HISHAM ODISH | 6/19/06 |

DRAWING TITLE:

Standard LED With 5V Resistor, Round Lens, 3mm (T1), RED

| | | | |
|------------|---------------------|-----------------|-----|
| SIZE | DWG. NO. | ELECTRONIC FILE | REV |
| A | MC20407 | 87K7043.DWG | A |
| SCALE: NTS | U.Q.M.: mm [INCHES] | SHEET: 1 OF 2 | |

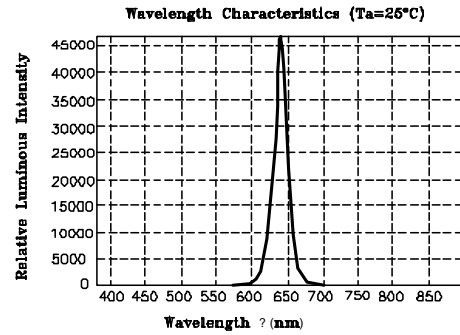
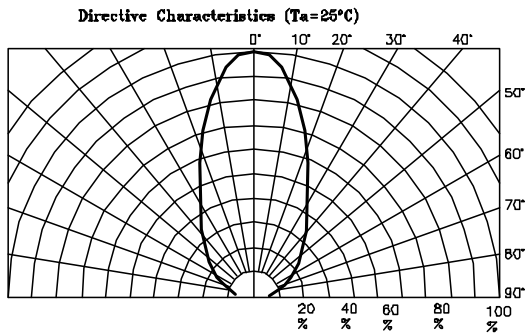
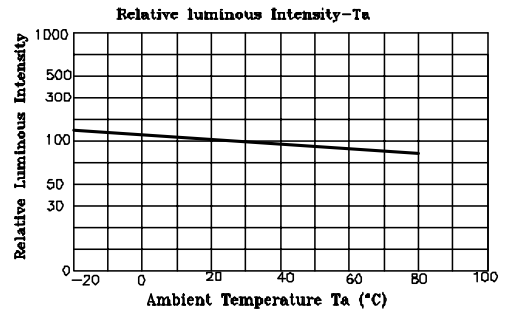
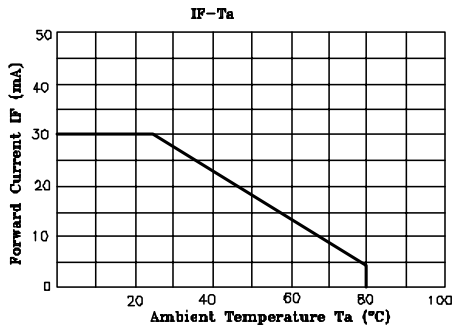
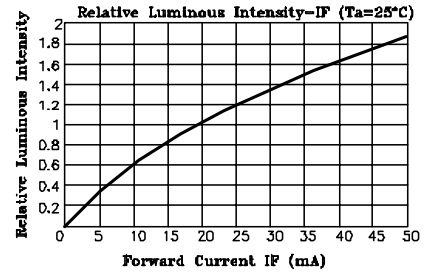
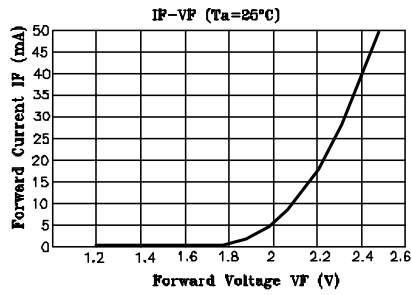

ALL RIGHTS RESERVED. NO PORTION OF THIS PUBLICATION, WHETHER IN WHOLE OR IN PART CAN BE REPRODUCED WITHOUT THE EXPRESS WRITTEN CONSENT OF SPC TECHNOLOGY.

SPC-F005.DWG

DOC. NO. SPC-F005 * Effective: 7/8/02 * DCP No: 1388

SIZE

A

DWG. NO.

MC20407

ELECTRONIC FILE

87K7043.DWG

REV

A

SCALE: NTS

U.Q.M.: mm [INCHES]

SHEET: 2 OF 2