



ALL RIGHTS RESERVED. NO PORTION OF THIS PUBLICATION, WHETHER IN WHOLE OR IN PART, CAN BE REPRODUCED WITHOUT THE EXPRESS WRITTEN CONSENT OF SPC TECHNOLOGY.

SPC-F005.DWG

REVISIONS

DOC. NO. SPC-F005 • Effective: 7/8/02 • DCP No: 1398

DCP #	REV	DESCRIPTION	DRAWN	DATE	CHECKD	DATE	APPRVD	DATE
1908	A	RELEASED	EO	6/7/06	YA	6/19/06	HO	6/19/06



Features:

- High intensity
- Standard 5mm (T1 3/4) Diameter package
- General purpose LED
- Reliable and rugged
- Low Current

Specifications:

- Lead spacing is measured where the leads emerge from the package

Source Color	Chip Material	Lens Color
Pure Green	GaP	Diffused

Absolute Maximum Rating at Ta=25°C

Parameter	MAX.	Unit
Power Dissipation	80	mW
Peak Forward Current (1/10 Duty Cycle, 0.1ms Pulse Width)	100	mA
Continuous Forward Current	20	mA
Derating Linear From 50°C	0.4	mA/°C
Reverse Voltage	5	V
Operating Temperature Range	-25°C to +80°C	
Storage Temperature Range	-40°C to +100°C	
Lead Soldering Temperature [4mm (0.157) From Body]	260°C for 5 seconds	

Electrical Optical Characteristics at Ta=25°C

Parameter	Symbol	Min.	Typ.	Max	Unit	Test Condition
Luminous Intensity	I_v		45		mcd	$I_f=20\text{mA}$ (Note 1)
Viewing Angle	$2\theta_{1/2}$		35		Deg	(Note 2)
Peak Emission Wavelength	λ_p		568		nm	$I_f=20\text{mA}$
Dominant Wavelength	λ_d		565		nm	$I_f=20\text{mA}$ (Note 3)
Spectral Line Half-Width	$\Delta\lambda$		25		nm	$I_f=20\text{mA}$
Forward Voltage	V_f		2.0	2.5	V	$I_f=20\text{mA}$
Reverse Current	I_R	---	---	100	μA	$V_R=5\text{V}$

Notes:

- 1- Luminous intensity is measured with a light sensor and filter combination that approximates the CIE eye-response curve.
- 2- $\theta_{1/2}$ is the off-axis angle at which the luminous intensity is half the axial luminous intensity
- 3- The dominant wavelength (λ_d) is derived from the CIE chromaticity diagram and represents the single wavelength which defines the color of the device.

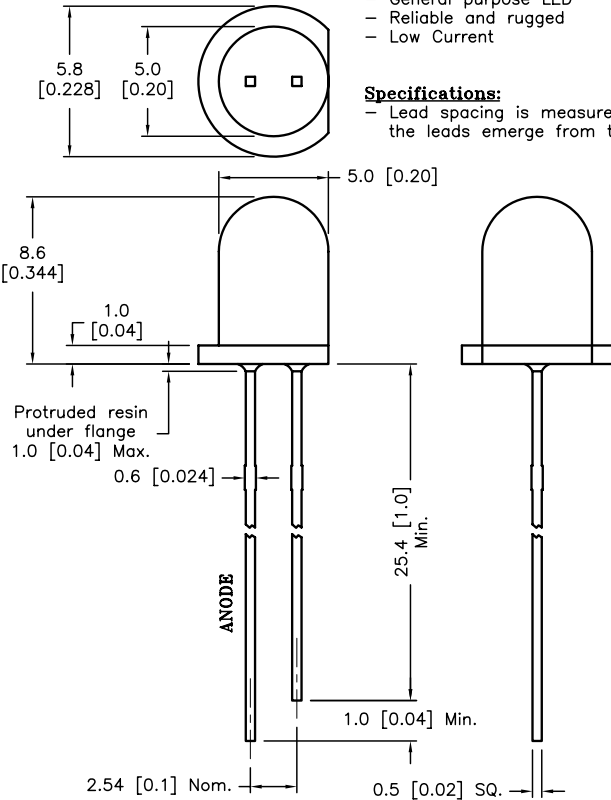

DISCLAIMER:
ALL STATEMENTS AND TECHNICAL INFORMATION CONTAINED HEREIN ARE BASED UPON INFORMATION AND/OR TESTS WE BELIEVE TO BE ACCURATE AND RELIABLE. SINCE CONDITIONS OF USE ARE BEYOND OUR CONTROL, THE USER SHALL DETERMINE THE SUITABILITY OF THE PRODUCT FOR THE INTENDED USE AND ASSUME ALL RISK AND LIABILITY WHATSOEVER IN CONNECTION THEREWITH.

TOLERANCES:

UNLESS OTHERWISE SPECIFIED,
 ± 0.25 [± 0.010]

DRAWN BY:	DATE:
EKLAS ODISH	6/7/06
CHECKED BY:	DATE:
YILMAZ AKYONDEM	6/19/06
APPROVED BY:	DATE:
HISHAM ODISH	6/19/06

DRAWING TITLE:

Low Current LED, Round Lens, 5mm (T1 3/4), Pure Green Emitting Color

SIZE	DWG. NO.	ELECTRONIC FILE	REV
A	HLMP4740	87K6990.DWG	A
SCALE: NTS	U.O.M.: mm [INCHES]	SHEET: 1 OF 2	

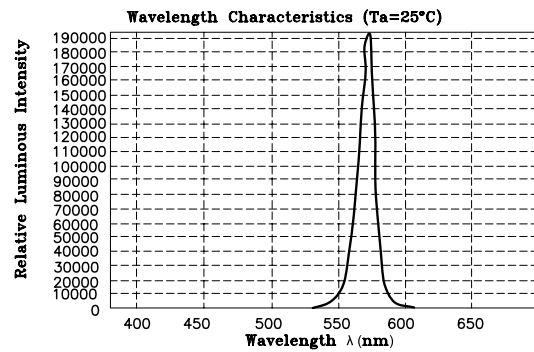
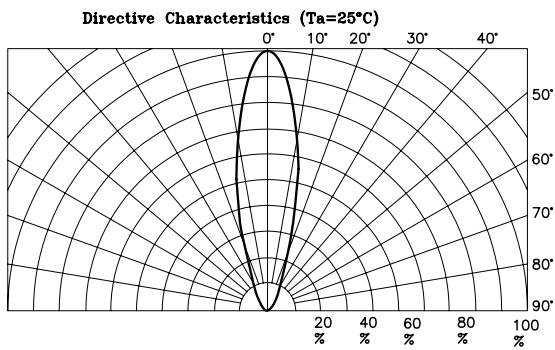
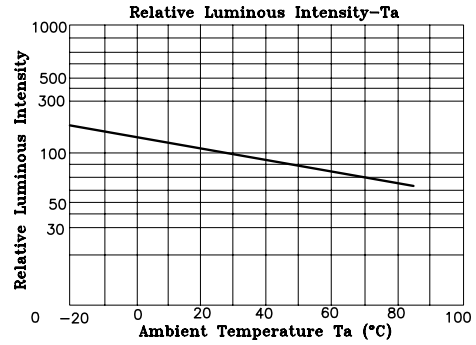
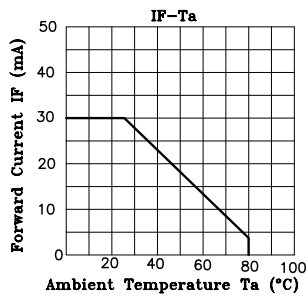
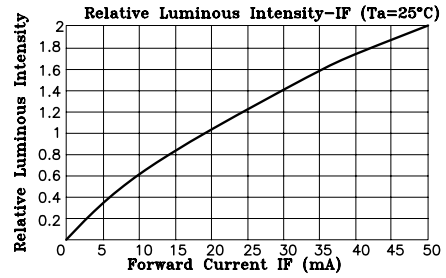
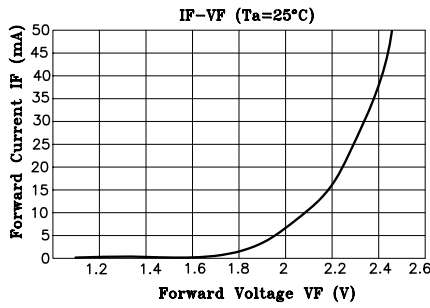

ALL RIGHTS RESERVED. NO PORTION OF THIS PUBLICATION, WHETHER IN WHOLE OR IN PART CAN BE REPRODUCED WITHOUT THE EXPRESS WRITTEN CONSENT OF SPC TECHNOLOGY.

SIZE	DWG. NO.	ELECTRONIC FILE	REV
A	HLMP4740	87K6990.DWG	A
SCALE: NTS	U.O.M.: mm [INCHES]	SHEET: 2 OF 2	

SPC-F005.DWG

DOC. NO. SPC-F005 * Effective: 7/8/02 * DCP No: 1398