



ALL RIGHTS RESERVED. NO PORTION OF THIS PUBLICATION, WHETHER IN WHOLE OR IN PART CAN BE REPRODUCED WITHOUT THE EXPRESS WRITTEN CONSENT OF SPC TECHNOLOGY.

SPC-F005.DWG

REVISIONS

DOC. NO. SPC-F005 * Effective: 7/8/02 * DCP No: 1398

DCP #	REV	DESCRIPTION	DRAWN	DATE	CHECKD	DATE	APPRVD	DATE
1908	A	RELEASED	JN	10/22/09	JN	10/22/09	JN	10/22/09

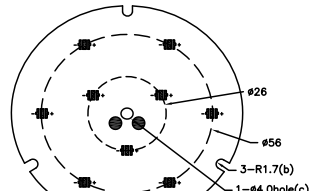
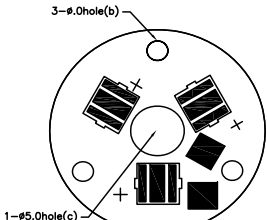
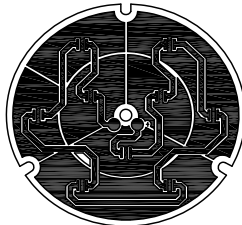
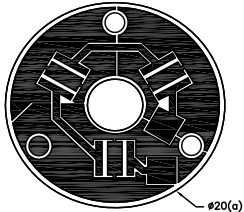
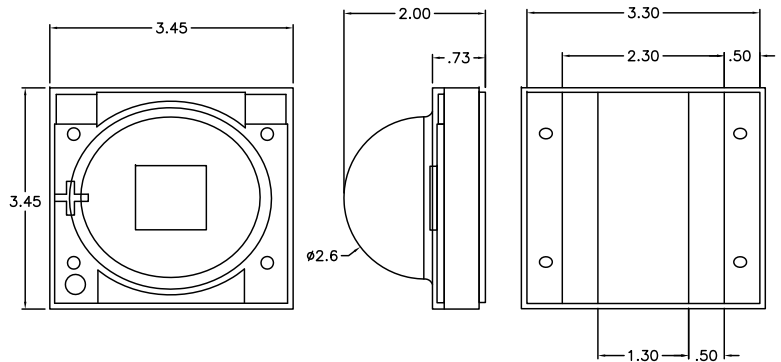
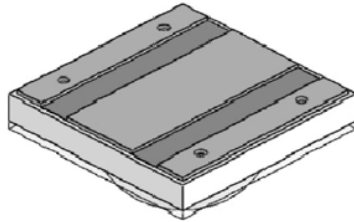
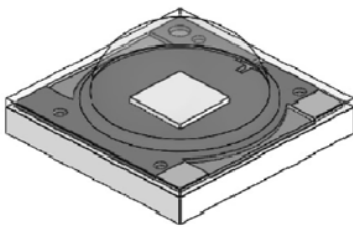

Figure 1

Figure 2

3 LED XPE MCPCB

White mask Black letter

10

9 LED XPE MCPCB

Black mask Gold letter

11

MFG PART NO.	BRD	LED Q'ty	BRD Thickness	LED Color	LED Color bins	each LED Flux Code	each LED Lumen (min.)	each LED VF (typ.) @350mA	each LED Viewing Angle
XPEWHT-L1-0000-00E02-3UP	rd	3 LED (Figure 1)	1.5mm	Cool White	WC, WD, WG, WF	R2	114lm	3.2V	115deg
XPEWHT-L1-0000-00BE4-3UP	rd		1.5mm	Neutral White	4A, 4B, 4C, 4D	Q3	93.9lm	3.2V	115deg
XPEWHT-L1-0000-009E7-3UP	rd		1.5mm	Warm White	7A, 7B, 7C, 7D	P4	80.6lm	3.2V	115deg
XPEWHT-L1-0000-00E02-9UP	rd	9 LED (Figure 2)	2mm	Cool White	WC, WD, WG, WF	R2	114lm	3.2V	115deg
XPEWHT-L1-0000-00BE4-9UP	rd		2mm	Neutral White	4A, 4B, 4C, 4D	Q3	93.9lm	3.2V	115deg
XPEWHT-L1-0000-009E7-9UP	rd		2mm	Warm White	7A, 7B, 7C, 7D	P4	80.6lm	3.2V	115deg

DISCLAIMER:
ALL STATEMENTS AND TECHNICAL INFORMATION CONTAINED HEREIN ARE BASED UPON INFORMATION AND/OR TESTS WE BELIEVE TO BE ACCURATE AND RELIABLE. SINCE CONDITIONS OF USE ARE BEYOND OUR CONTROL, THE USER SHALL DETERMINE THE SUITABILITY OF THE PRODUCT FOR THE INTENDED USE AND ASSUME ALL RISK AND LIABILITY WHATSOEVER IN CONNECTION THEREWITH.

TOLERANCES:
UNLESS OTHERWISE SPECIFIED, DIMENSIONS ARE FOR REFERENCE PURPOSES ONLY.

DRAWN BY:	DATE:
Jason Nash	10/22/09
CHECKED BY:	DATE:
Jason Nash	10/22/09
APPROVED BY:	DATE:
Jason Nash	10/22/09

DRAWING TITLE:			
LED Array Utilizing Cree's XPE Emitters			
SIZE	DWG. NO.	ELECTRONIC FILE	REV
A	Ta-1203	Ta-1203.dwg	A
SCALE: NTS		U.O.M.: mm [INCHES]	SHEET: 1 OF 1