



LUXEON Rebel
Direct Color Portfolio

*High power
colored LEDs*

Technical Datasheet DS65

L U X E N[®]
never before possible



LUXEON[®] Rebel

Direct Color Portfolio

Introduction

LUXEON[®] Rebel Direct Color portfolio LEDs are ideal for a wide variety of lighting, signaling, signage and entertainment applications. These flux differentiated parts, like all other LUXEON Rebel LEDs, provide the industry's best lumen maintenance, superior reliability and quality light. Using the information in this document you can begin designing applications to your unique specifications.

LUXEON Rebel Direct Color LEDs

- deliver more usable light and higher flux density
- optimize applications to reduce size and cost
- tightly pack the LEDs for mixing
- engineer more robust applications
- utilize standard FR4 PCB technology
- simplify manufacturing through the use of surface mount technology
- recognized under the Component Recognition Program of Underwriters Laboratories Inc. UL listing E327436.

PHILIPS
LUMILEDS

Table of Contents

General Product Information	3
Product Nomenclature	3
Average Lumen Maintenance Characteristics.....	3
Environmental Compliance	3
Flux Characteristics.....	4
Flux Performance, Binning, and Supportability.....	5
Optical Characteristics.....	6
Electrical Characteristics.....	7
Absolute Maximum Ratings	8
JEDEC Moisture Sensitivity.....	8
Reflow Soldering Characteristics.....	9
Mechanical Dimensions	10
Pad Configuration.....	11
Solder Pad Design.....	11
Wavelength Characteristics.....	12
Typical Light Output Characteristics over Temperature.....	13
Typical Forward Current Characteristics	14
Typical Relative Luminous Flux	15
Current Derating Curves.....	16
Typical Radiation Patterns.....	20
Emitter Pocket Tape Packaging.....	22
Emitter Reel Packaging	23
Product Binning and Labeling	24
Luminous Flux Bins.....	25
Forward Voltage Bins.....	26
Color Bins.....	27

General Product Information

Product Nomenclature

LUXEON Rebel Direct Color is tested and binned at 350 mA.

The part number designation is explained as follows:

L X M L - A B C D - E F G H

L X M 2 - A B C D - E F G H

Where:

A — designates radiation pattern (value P for Lambertian)

B — designates color (see LUXEON Rebel Binning and Labeling section)

C — designates color variant (0 for direct colored variants)

D — designates test current (value I for 350 mA)

E — reserved for future product offerings

FGH — minimum luminous flux (lm) or radiometric power (mW) performance

Therefore products tested and binned at 350 mA follow the part numbering scheme:

L X M L - P x 0 I - x x x x

L X M 2 - P x 0 I - x x x x

Average Lumen Maintenance Characteristics

LUXEON Rebel Direct Color emitters are tested and binned at 350 mA, with current pulse duration of 20 ms. All characteristic charts where the thermal pad is kept at constant temperature (25°C typically) are measured with current pulse duration of 20 ms. Under these conditions, junction temperature and thermal pad temperature are the same.

Philips Lumileds projects that green, cyan, blue and royal-blue LUXEON Rebel Direct Color products will deliver, on average, 70% lumen maintenance (B50, L70) at 50,000 hours of operation at a forward current of 700 mA. This projection is based on constant current operation with junction temperature maintained at or below 135°C.

Philips Lumileds projects that red, red-orange and amber LUXEON Rebel Direct Color products will deliver, on average, 70% lumen maintenance (B50, L70) at 50,000 hours of operation at a forward current of 350 mA. This projection is based on constant current operation with junction temperature maintained at or below 110°C.

This performance is based on independent test data, Philips Lumileds historical data from tests run on similar material systems, and internal LUXEON reliability testing. Observation of design limits included in this data sheet is required in order to achieve this projected lumen maintenance.

Environmental Compliance

Philips Lumileds is committed to providing environmentally friendly products to the solid-state lighting market. LUXEON Rebel products are compliant to the European Union directives on the restriction of hazardous substances in electronic equipment, namely REACH and the RoHS directive. Philips Lumileds will not intentionally add the following restricted materials to the LUXEON Rebel: lead, mercury, cadmium, hexavalent chromium, polybrominated biphenyls (PBB) or polybrominated diphenyl ethers (PBDE).

Flux Characteristics

Luminous Flux Characteristics for LUXEON Rebel, Thermal Pad Temperature=25°C

Table I.

		Performance at Test Current		Typical Performance at Indicated Current	
Color	Part Number	Minimum Luminous Flux (lm) or Radiometric Power (mW) Φ_V [1]	Test Current (mA)	Typical Luminous Flux (lm) or Radiometric Power (mW) Φ_V [2]	Drive Current (mA)
Green	LXML-PM01-0070	70	350	123	700
	LXML-PM01-0080	80	350	139	700
	LXML-PM01-0090	90	350	150	700
	LXML-PM01-0100	100	350	166	700
Cyan	LXML-PE01-0050	50	350	91	700
	LXML-PE01-0060	60	350	107	700
	LXML-PE01-0070	70	350	120	700
	LXML-PE01-0080	80	350	129	700
Blue	LXML-PB01-0013	13.9	350	28	700
	LXML-PB01-0018	18.1	350	37	700
	LXML-PB01-0023	23.5	350	48	700
	LXML-PB01-0030	30.0	350	58	700
	LXML-PB01-0040	40.0	350	70	700
Royal-Blue	LXML-PR01-0350	350 mW	350	625 mW	700
	LXML-PR01-0425	425 mW	350	740 mW	700
	LXML-PR01-0500	500 mW	350	875 mW	700
Red	LXML-PD01-0030	30	350	65	700
	LXML-PD01-0040	40	350	85	700
	LXM2-PD01-0040*	40	350	90	700
	LXM2-PD01-0050*	50	350	102	700
Red-Orange	LXML-PH01-0040	40	350	85	700
	LXML-PH01-0050	50	350	100	700
	LXM2-PH01-0060*	60	350	122	700
	LXM2-PH01-0070*	70	350	134	700
Amber	LXML-PL01-0023	23.5	350	50	700
	LXML-PL01-0030	30.0	350	65	700
	LXML-PL01-0040	40.0	350	86	700

* Low Vf parts.

See table notes on next page.

Luminous Flux Characteristics for LUXEON Rebel, Continued

Notes for Table 1:

1. Minimum luminous flux or radiometric power performance guaranteed within published operating conditions. Philips Lumileds maintains a tolerance of $\pm 6.5\%$ on flux and power measurements.
2. Typical luminous flux or radiometric power performance when device is operated within published operating conditions.

Flux Performance, Binning, and Supportability

LEDs are produced with semiconductor technology that is subject to process variation, yielding a range of flux performance that is approximately Gaussian in nature. In order to provide customers with fine granularity within the overall flux distribution, Philips Lumileds separates LEDs into fixed, easy to design with, minimum luminous flux bins. To verify supportability of parts chosen for your application design, please consult your Philips Lumileds or Future Lighting Solutions sales representative.

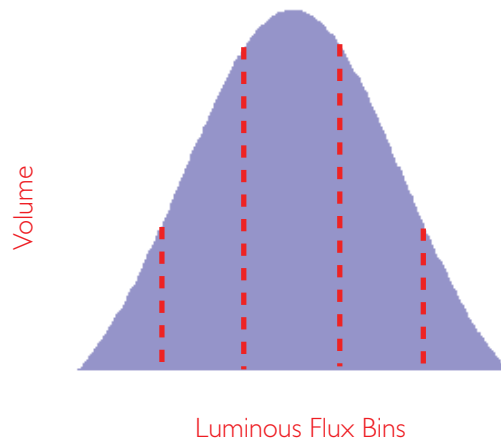

Optical Characteristics

LUXEON Rebel at Test Current ^[1] Thermal Pad Temperature = 25°C

Table 2.

Color	Dominant Wavelength ^[2] λ_D , or Peak Wavelength ^[3] λ_P			Typical Spectral Half-width ^[4] (nm) $\Delta\lambda_{1/2}$	Typical Temperature Coefficient of Dominant Wavelength (nm/°C) $\Delta\lambda_D / \Delta T_J$	Typical Total Included Angle ^[5] (degrees) $\theta_{0.90V}$	Typical Viewing Angle ^[6] (degrees) $2\theta_{1/2}$
	Min.	Typ.	Max.				
Green ^[7]	520.0 nm	530.0 nm	550.0 nm	30	0.05	160	120
Cyan ^[7]	490.0 nm	505.0 nm	520.0 nm	30	0.04	160	120
Blue ^[7]	460.0 nm	470.0 nm	490.0 nm	20	0.05	160	120
Royal-Blue ^{[3] [7]}	440.0 nm	447.5 nm	460.0 nm	20	0.04	160	120
Red ^[8]	620.0 nm	627.0 nm	645.0 nm	20	0.05	160	120
Red-Orange ^[8]	610.0 nm	617.0 nm	620.0 nm	20	0.08	160	120
Amber ^[8]	584.5 nm	590.0 nm	597.0 nm	20	0.10	160	120

Notes for Table 2:

1. Test current is 350 mA for all LXML-PxxI-0xxx and LXM2-PxxI-0xxx products.
2. Dominant wavelength is derived from the CIE 1931 Chromaticity diagram and represents the perceived color. Philips Lumileds maintains a tolerance of ± 0.5 nm for dominant wavelength measurements.
3. Royal-Blue product is binned by radiometric power and peak wavelength rather than photometric lumens. Philips Lumileds maintains a tolerance of ± 2 nm for peak wavelength measurements.
4. Spectral width at $1/2$ of the peak intensity.
5. Total angle at which 90% of total luminous flux is captured.
6. Viewing angle is the off axis angle from lamp centerline where the luminous intensity is $1/2$ of the peak value.
7. All green, cyan, blue and royal-blue products are built with Indium Gallium Nitride (InGaN).
8. All red, red-orange, and amber are built with Aluminum Indium Gallium Phosphide (AlInGaP).

Electrical Characteristics

Electrical Characteristics at 350 mA for LUXEON Rebel, Part Numbers LXML-PxxI-0xxx and LXM2-PxxI-0xxx, Thermal Pad Temperature = 25°C

Table 3.

Color	Forward Voltage V_f ^[1] (V)			Typical Temperature Coefficient of Forward Voltage ^[2] (mV/°C) $\Delta V_f / \Delta T_J$	Typical Thermal Resistance Junction to Thermal Pad (°C/W) $R\theta_{J-C}$
	Min.	Typ.	Max.		
Green	2.55	3.05	3.51	- 2.0 to - 4.0	10
Cyan	2.55	3.05	3.51	- 2.0 to - 4.0	10
Blue	2.55	3.10	3.51	- 2.0 to - 4.0	10
Royal-Blue	2.55	3.05	3.51	- 2.0 to - 4.0	10
Red	2.31	2.90	3.51	- 2.0 to - 4.0	12
Red (Low Vf)	1.80	2.10	2.80	- 2.0 to - 4.0	8
Red-Orange	2.31	2.90	3.51	- 2.0 to - 4.0	12
Red-Orange (Low Vf)	1.80	2.10	2.80	- 2.0 to - 4.0	8
Amber	2.31	2.90	3.51	- 2.0 to - 4.0	12

Notes for Table 3:

1. Philips Lumileds maintains a tolerance of $\pm 0.06V$ on forward voltage measurements.
2. Measured between $25^\circ C = T_J = 110^\circ C$ at $I_f = 350$ mA.

Typical Electrical Characteristics at 700 mA for LUXEON Rebel, Part Numbers LXML-PxxI-0xxx and LXM2-PxxI-0xxx, Thermal Pad Temperature = 25°C

Table 4.

Color	Typical Forward Voltage V_f (V)
Green	3.40
Cyan	3.40
Blue	3.40
Royal-Blue	3.40
Red	3.60
Red (Low Vf)	2.30
Red-Orange	3.60
Red-Orange (Low Vf)	2.30
Amber	3.60

Absolute Maximum Ratings

Table 5.

Parameter	Green / Cyan / Blue / Royal-Blue	Red / Red-Orange / Amber
DC Forward Current (mA)	1000	700
Peak Pulsed Forward Current (mA)	1000	700
Average Forward Current (mA)	1000	700
ESD Sensitivity	< 8000V Human Body Model (HBM) Class 3A JESD22-A114-B	< 8000V Human Body Model (HBM) Class 3A JESD22-A114-B
LED Junction Temperature ^[1]	150°C	135°C
Operating Case Temperature at 350 mA	-40°C - 135°C	-40°C - 120°C
Storage Temperature	-40°C - 135°C	-40°C - 135°C
Soldering Temperature	JEDEC 020c 260°C	JEDEC 020c 260°C
Allowable Reflow Cycles	3	3
	Autoclave Conditions 121°C at 2 ATM 100% Relative Humidity for 96 Hours Maximum	Autoclave Conditions 121°C at 2 ATM 100% Relative Humidity for 96 Hours Maximum
Reverse Voltage (Vr)	See Note 2	See Note 2

Notes for Table 5:

1. Proper current derating must be observed to maintain junction temperature below the maximum.
2. LUXEON Rebel LEDs are not designed to be driven in reverse bias.

JEDEC Moisture Sensitivity

Table 6.

Level	Floor Life		Soak Requirements	
			Standard	
	Time	Conditions	Time (hours)	Conditions
I	unlimited	≤ 30°C / 85% RH	168 + 5 / -0	85°C / 85% RH

Reflow Soldering Characteristics

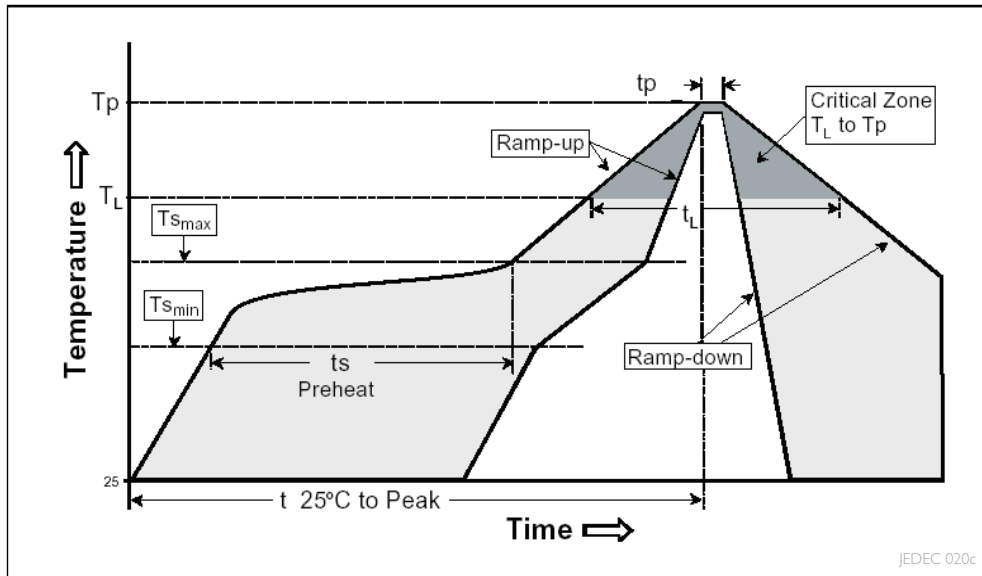

Table 7.

Profile Feature	Lead Free Assembly
Average Ramp-Up Rate ($T_{S_{max}}$ to T_p)	3°C / second max
Preheat Temperature Min ($T_{S_{min}}$)	150°C
Preheat Temperature Max ($T_{S_{max}}$)	200°C
Preheat Time ($t_{s_{min}}$ to $t_{s_{max}}$)	60 - 180 seconds
Temperature T_L (t_L)	217°C
Time Maintained Above Temperature T_L (t_L)	60 - 150 seconds
Peak / Classification Temperature (T_p)	260°C
Time Within 5°C of Actual Peak Temperature (t_p)	20 - 40 seconds
Ramp-Down Rate	6°C / second max
Time 25°C to Peak Temperature	8 minutes max

Note for Table 7:

- All temperatures refer to the application Printed Circuit Board (PCB), measured on the surface adjacent to the package body.

Mechanical Dimensions

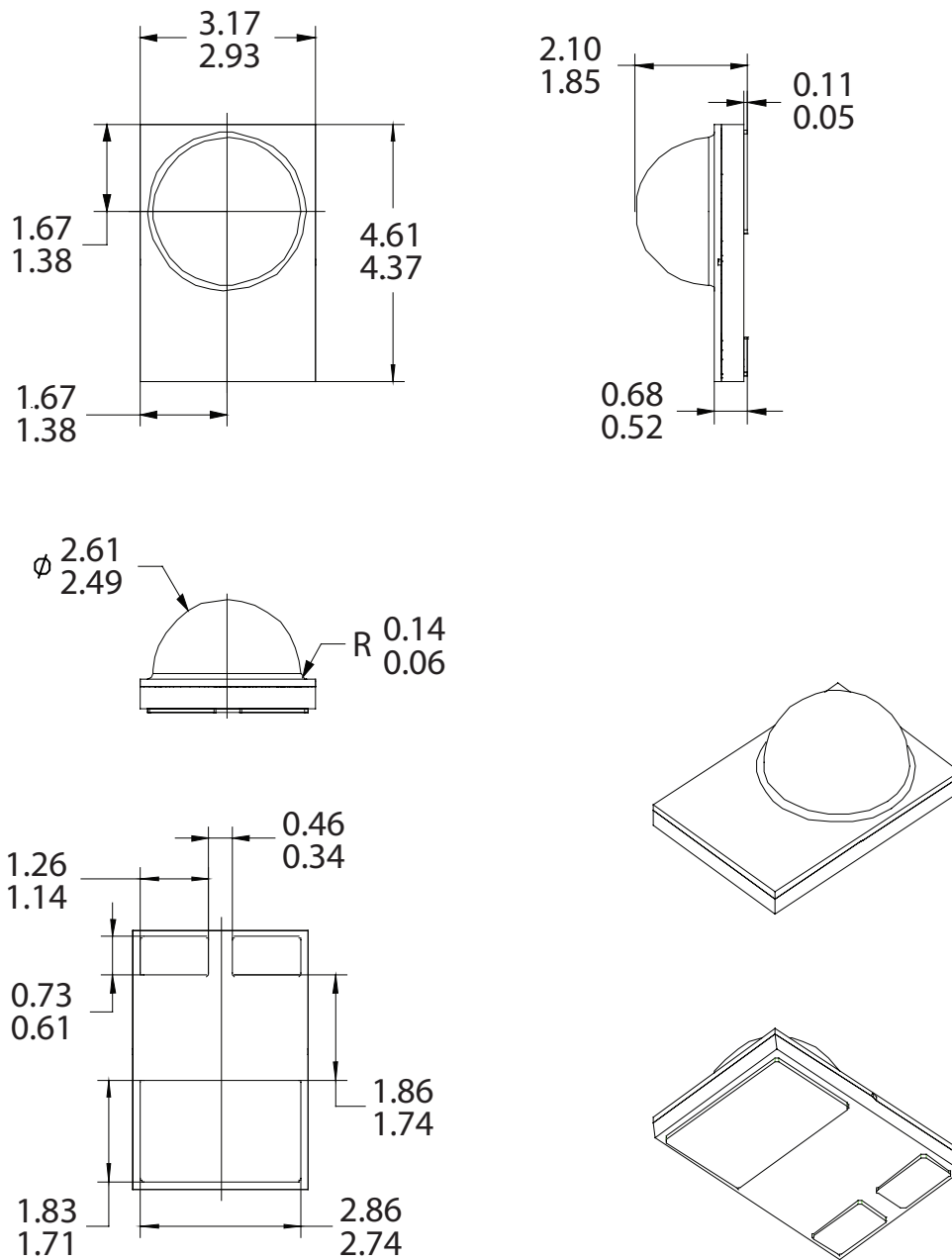
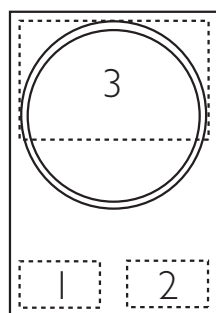

Figure 1. Package outline drawing.

Notes for Figure 1:

- To avoid damage, do not handle the device by the emitter lens.
- Drawings not to scale.
- All dimensions are in millimeters.
- The thermal pad is electrically isolated from the anode and cathode contact pads.

Pad Configuration



TOP

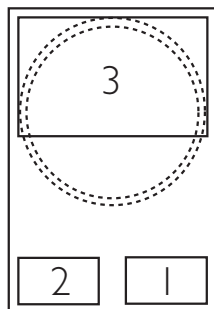

BOTTOM

PAD	FUNCTION
1	CATHODE
2	ANODE
3	THERMAL

Figure 2. Pad configuration.

Note for Figure 2:

- The thermal pad is electrically isolated from the anode and cathode contact pads.

Solder Pad Design

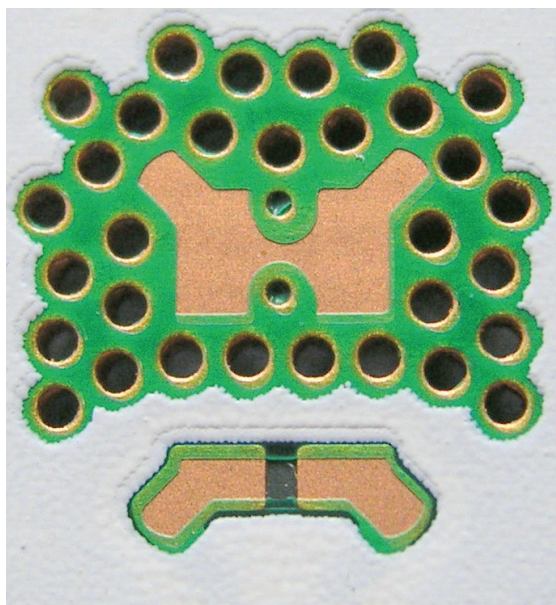

Figure 3. Solder pad layout.

Notes for Figure 3:

- The photograph shows the recommended LUXEON Rebel layout on printed circuit board (PCB). This design easily achieves a thermal resistance of 7K/W.
- Application Brief AB32 provides extensive details for this layout. The .dwg files are available at www.philipslumileds.com and www.philipslumileds.cn.com.

Wavelength Characteristics

Green, Cyan, Blue, Royal-Blue, Red, Red-Orange and Amber
at Test Current, Thermal Pad Temperature = 25°C

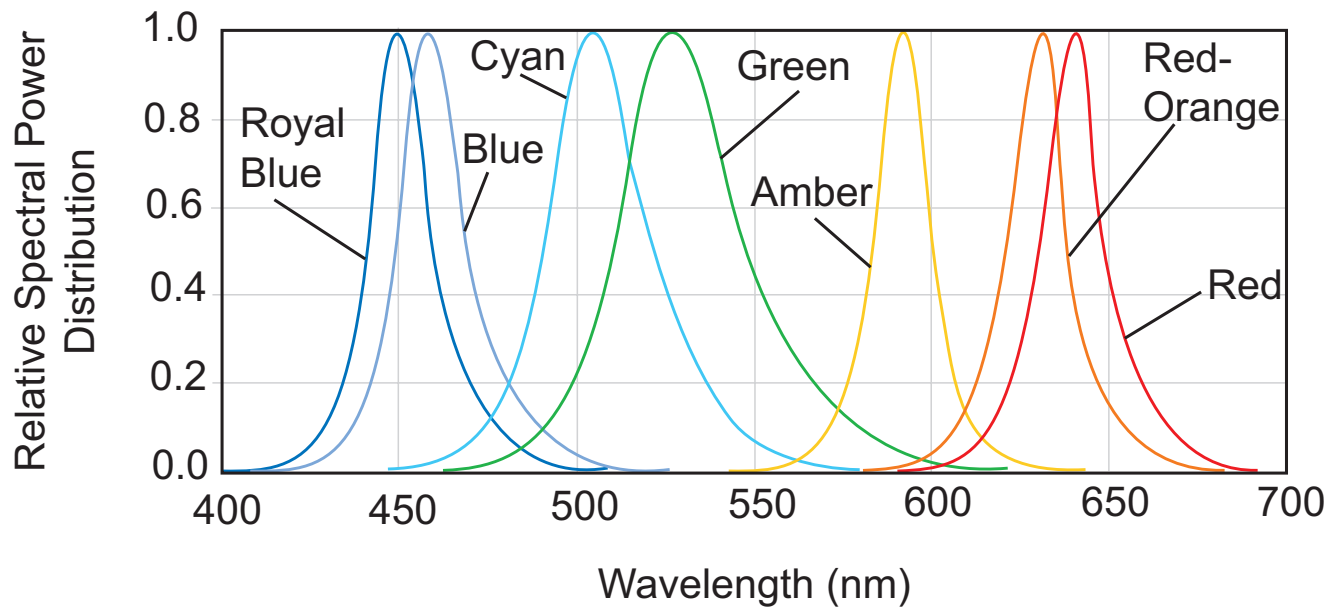

Figure 4. Relative intensity vs. wavelength.

Typical Light Output Characteristics over Temperature

Cyan, Blue and Royal-Blue at Test Current

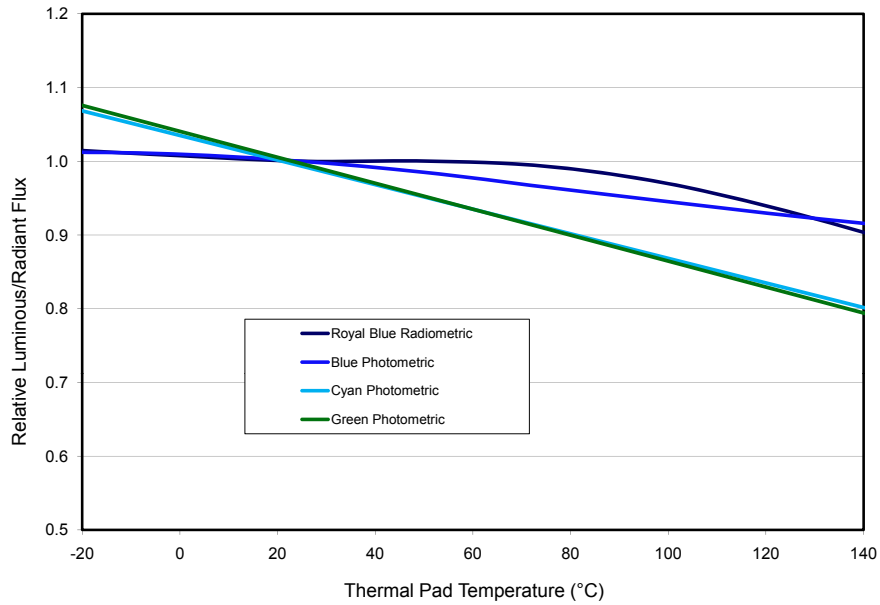

Figure 5. Relative light output vs. thermal pad temperature for green, cyan, blue and royal-blue.

Red, Red-Orange and Amber at Test Current

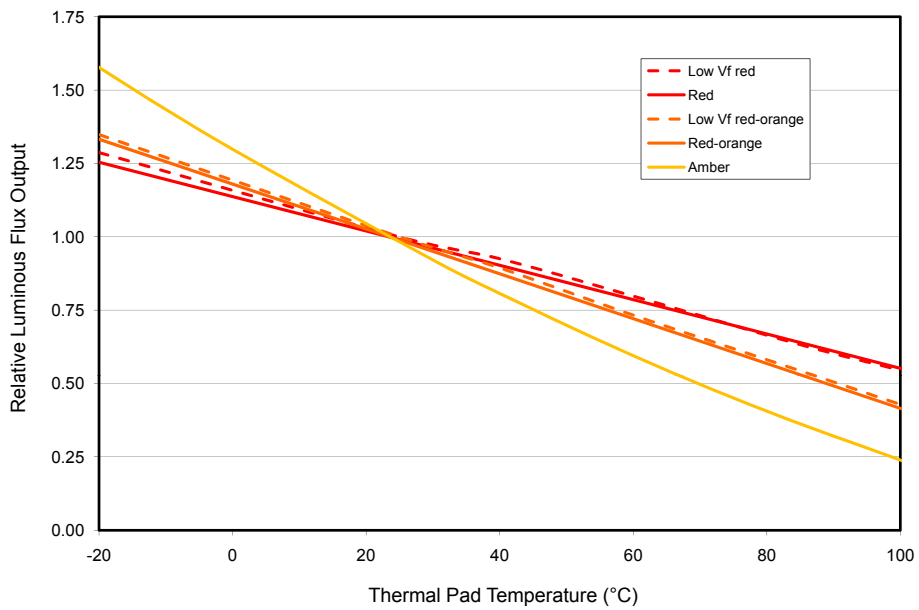

Figure 6. Relative light output vs. thermal pad temperature for red, red-orange and amber.

Typical Forward Current Characteristics

Green, Cyan, Blue and Royal-Blue Thermal Pad Temperature = 25°C

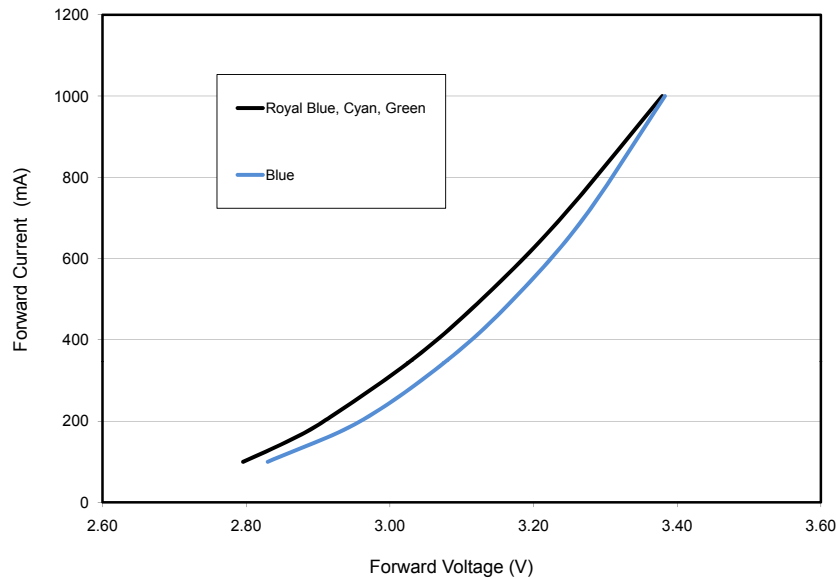

Figure 7. Forward current vs. forward voltage for green, cyan, blue and royal-blue.

Red, Red-Orange and Amber Thermal Pad Temperature = 25°C

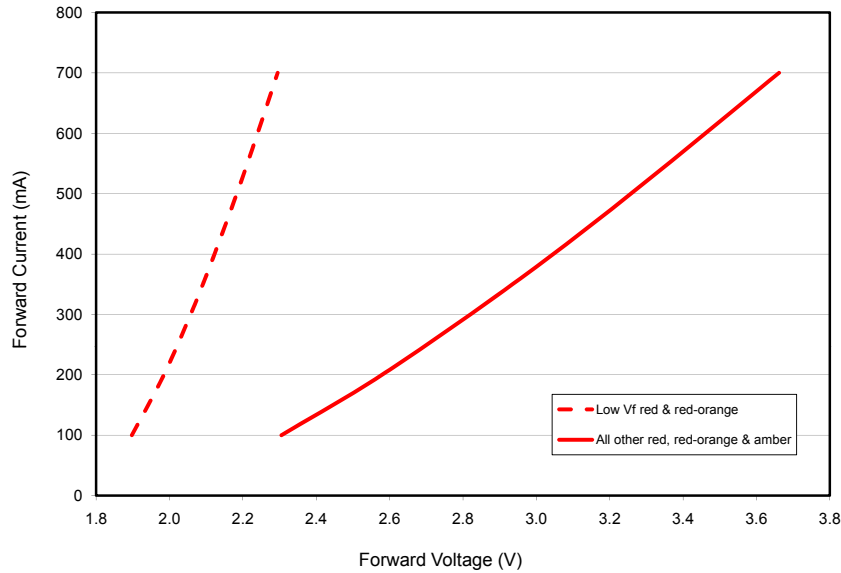

Figure 8. Forward current vs. forward voltage for red, red-orange, and amber.

Typical Relative Luminous Flux

Typical Relative Luminous Flux vs. Forward Current for Green, Cyan, Blue and Royal-Blue, Thermal Pad Temperature = 25°C

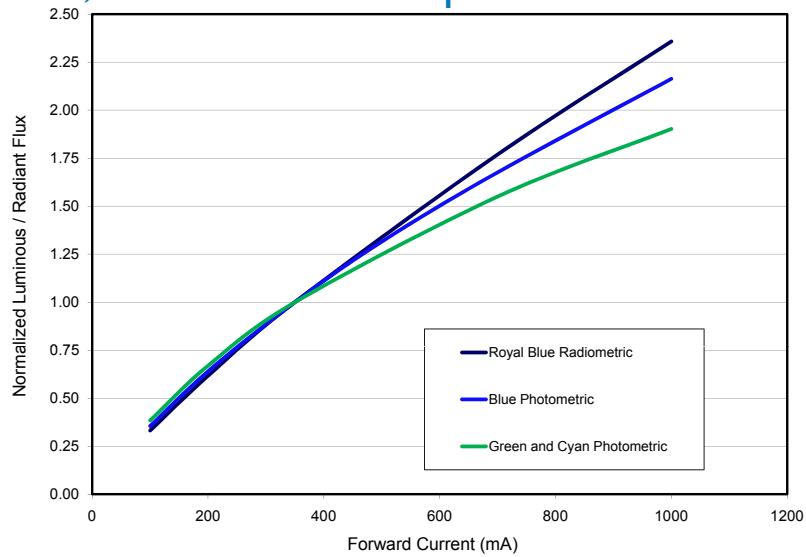

Figure 9. Relative luminous flux or radiometric power vs. forward current for green, cyan, blue and royal-blue at Thermal Pad = 25°C maintained.

Typical Relative Luminous Flux vs. Forward Current for Red, Red-Orange, Amber, Thermal Pad Temperature = 25°C

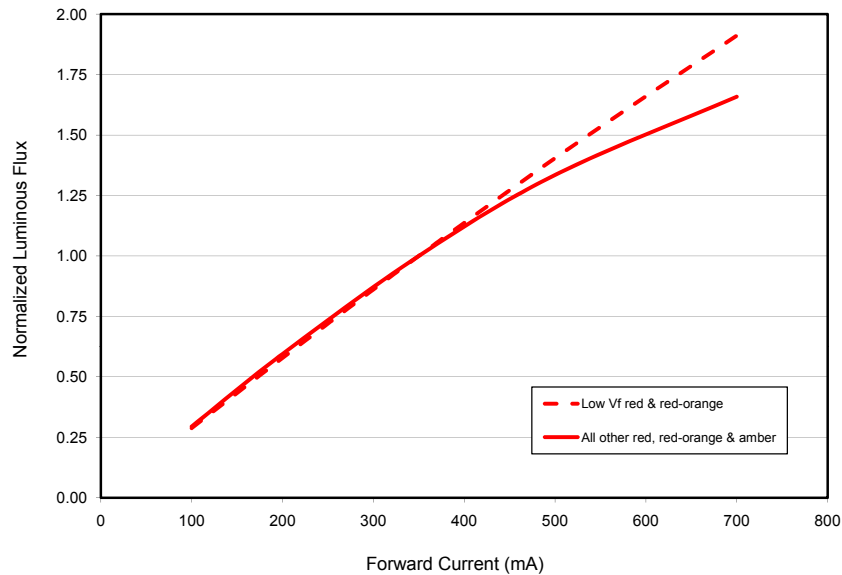

Figure 10. Relative luminous flux vs. forward current for red, red-orange and amber at Thermal Pad = 25°C maintained.

Current Derating Curves

Current Derating Curve for 350 mA Drive Current Green, Cyan, Blue and Royal-Blue

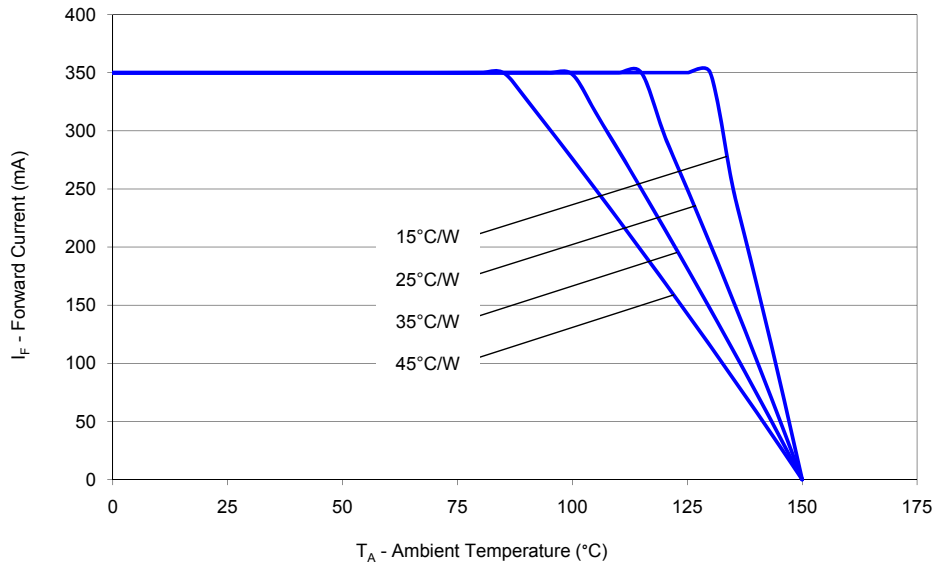

Figure 11. Maximum forward current vs. ambient temperature, based on $T_{JMAX} = 150^\circ\text{C}$.

Current Derating Curve for 350 mA Drive Current Red, Red-Orange, Amber

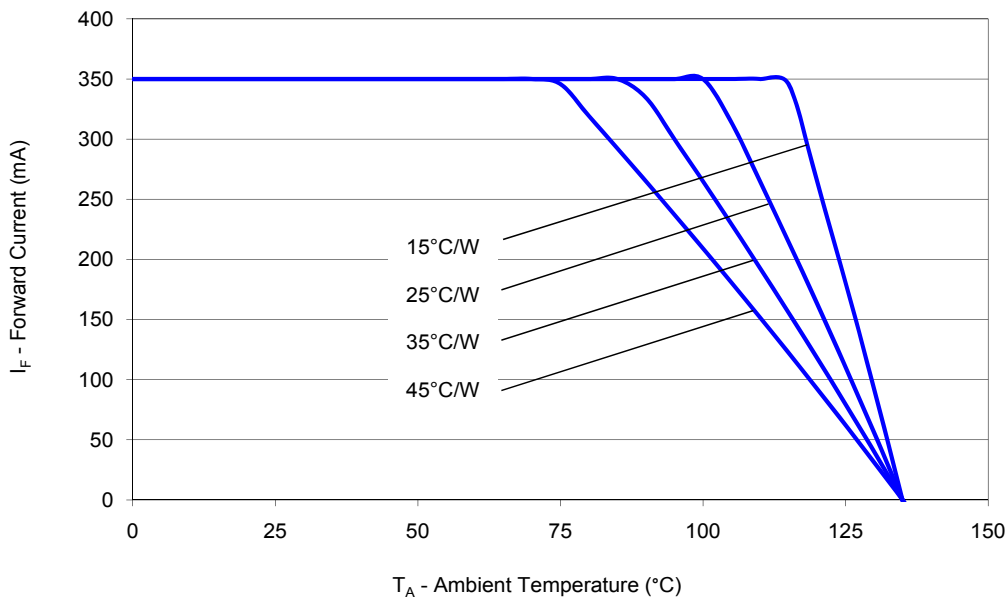

Figure 12. Maximum forward current vs. ambient temperature, based on $T_{JMAX} = 135^\circ\text{C}$.

Current Derating Curve for 350 mA Drive Current Red (low Vf)

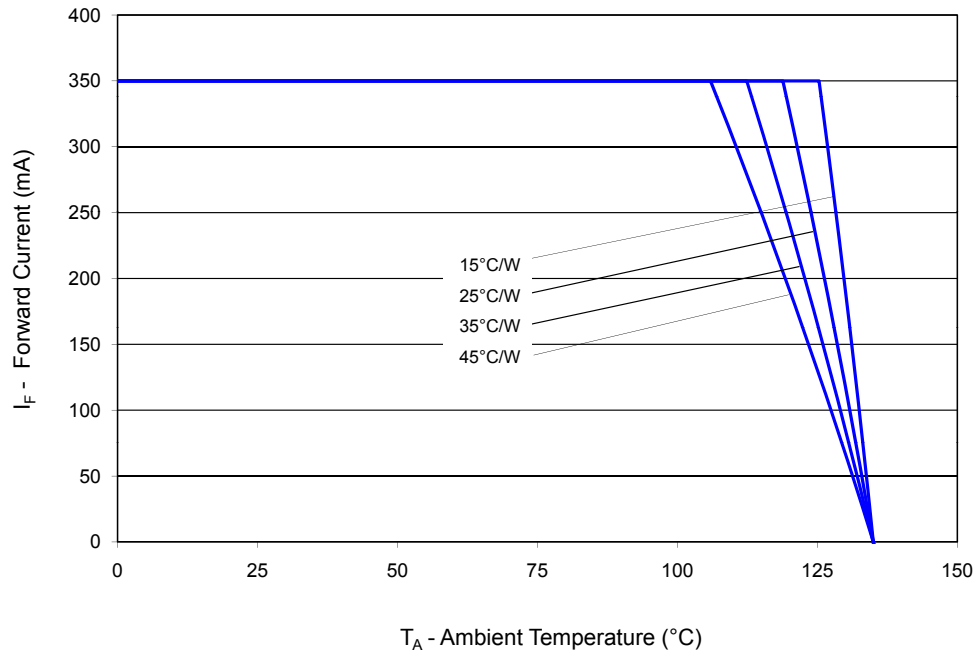

Figure 13. Maximum forward current vs. ambient temperature, based on $T_{JMAX} = 135^{\circ}\text{C}$.

Current Derating Curve for 700 mA Drive Current Green, Cyan, Blue and Royal-Blue

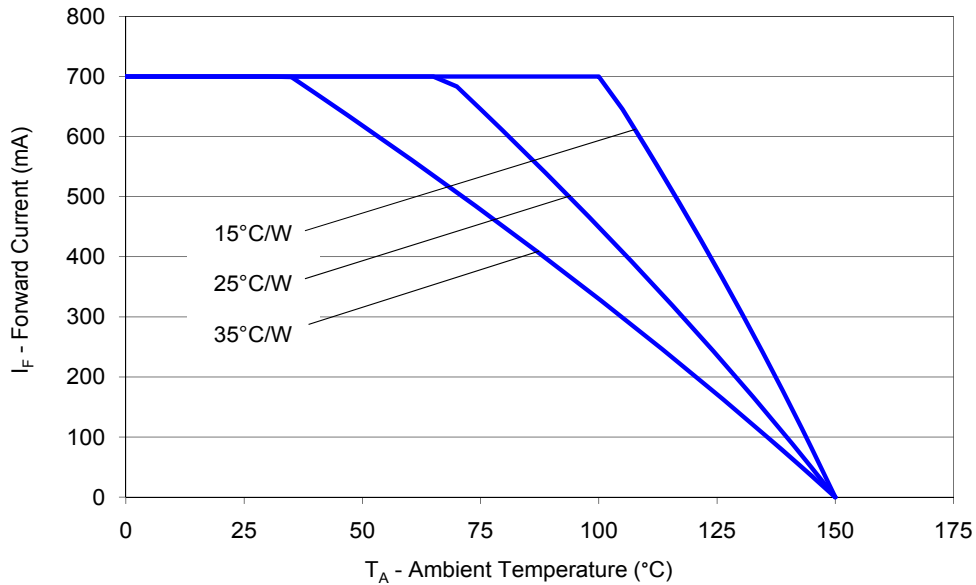

Figure 14. Maximum forward current vs. ambient temperature, based on $T_{JMAX} = 150^{\circ}C$.

Current Derating Curve for 700 mA Drive Current Red, Red-Orange, Amber

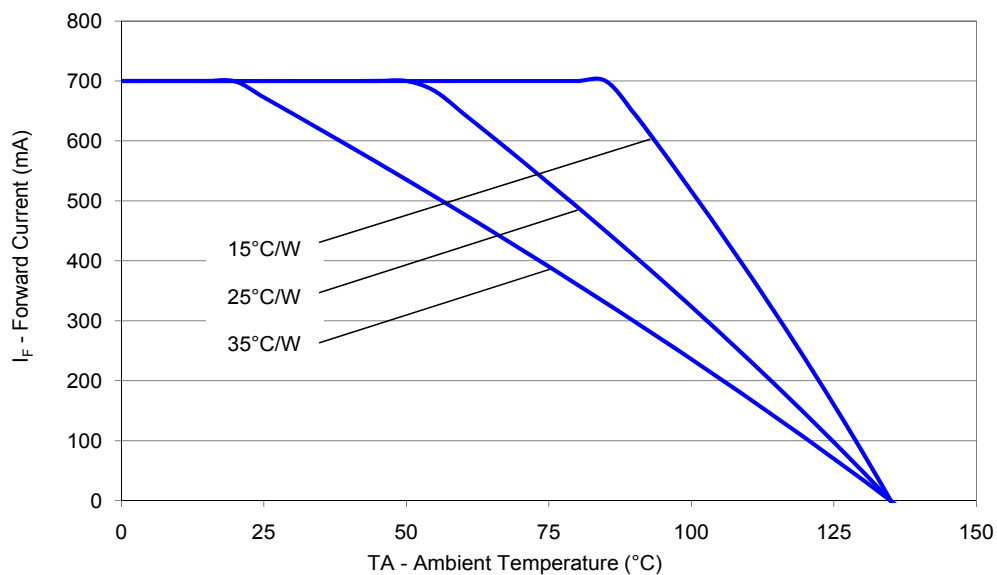

Figure 15. Maximum forward current vs. ambient temperature, based on $T_{JMAX} = 135^{\circ}C$.

Current Derating Curve for 700 mA Drive Current Red (low Vf)

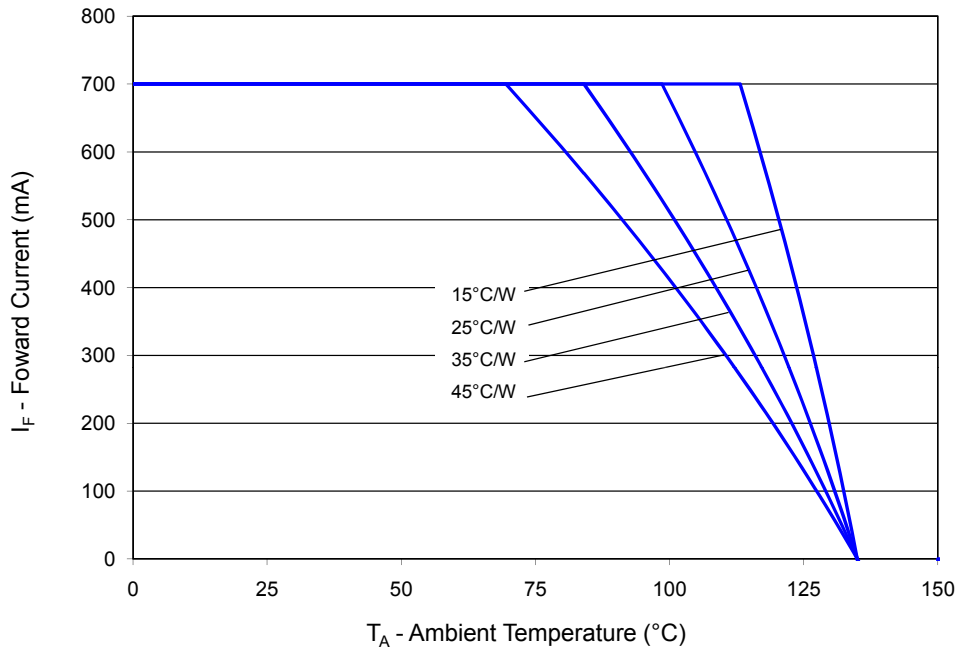

Figure 16. Maximum forward current vs. ambient temperature, based on $T_{JMAX} = 135^{\circ}\text{C}$.

Current Derating Curve for 1000 mA Drive Current Green, Cyan, Blue and Royal-Blue

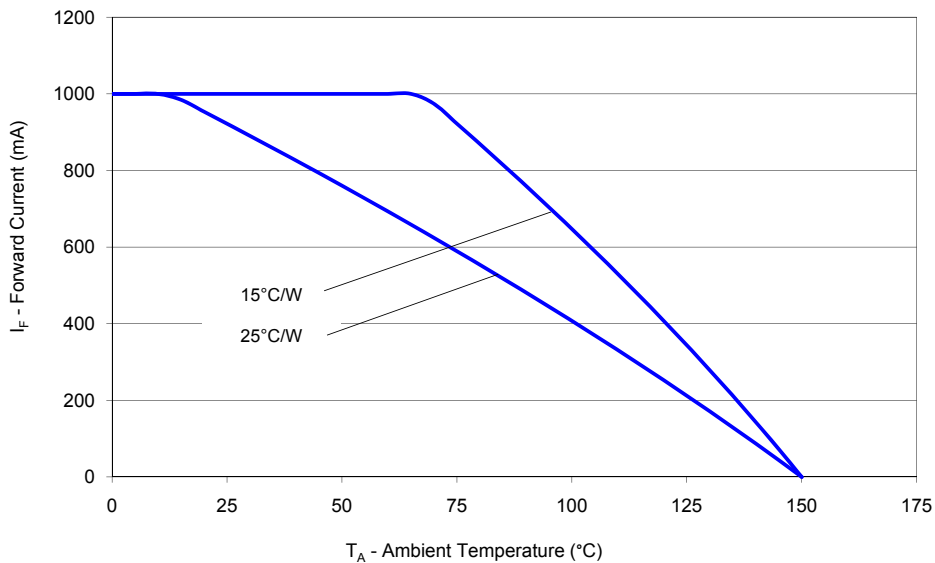

Figure 17. Maximum forward current vs. ambient temperature, based on $T_{JMAX} = 135^{\circ}\text{C}$.

Typical Radiation Patterns

Typical Spatial Radiation Pattern for Green, Cyan, Blue and Royal-Blue Lambertian

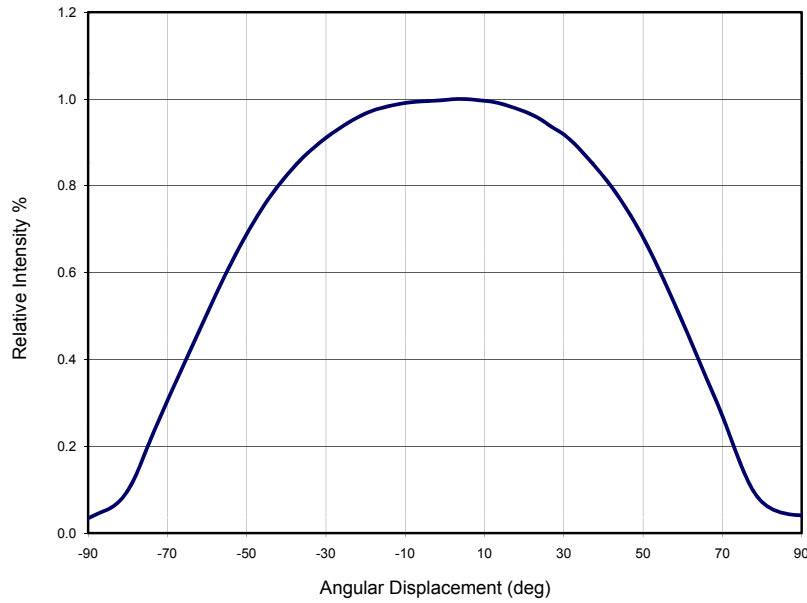

Figure 18. Typical spatial radiation pattern for green, cyan, blue, and royal-blue lambertian.

Typical Polar Radiation Pattern for Green, Cyan, Blue and Royal-Blue Lambertian

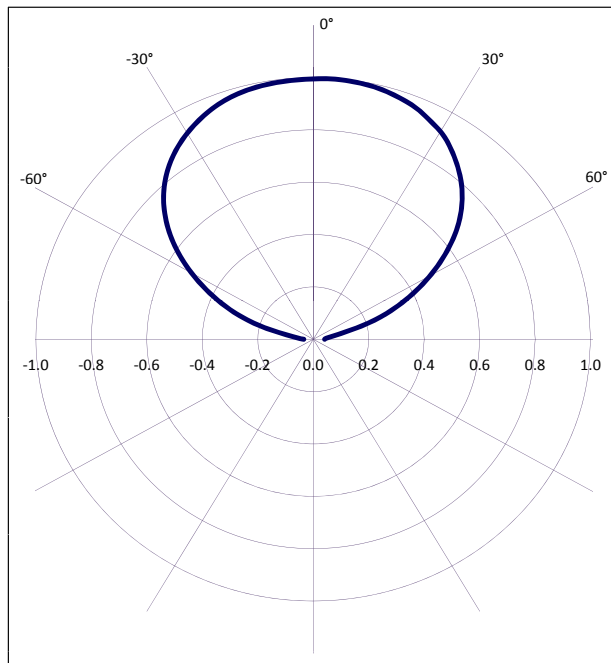

Figure 19. Typical polar radiation pattern for green, cyan, blue, and royal-blue lambertian.

Typical Spatial Radiation Pattern for Red, Red-Orange and Amber Lambertian

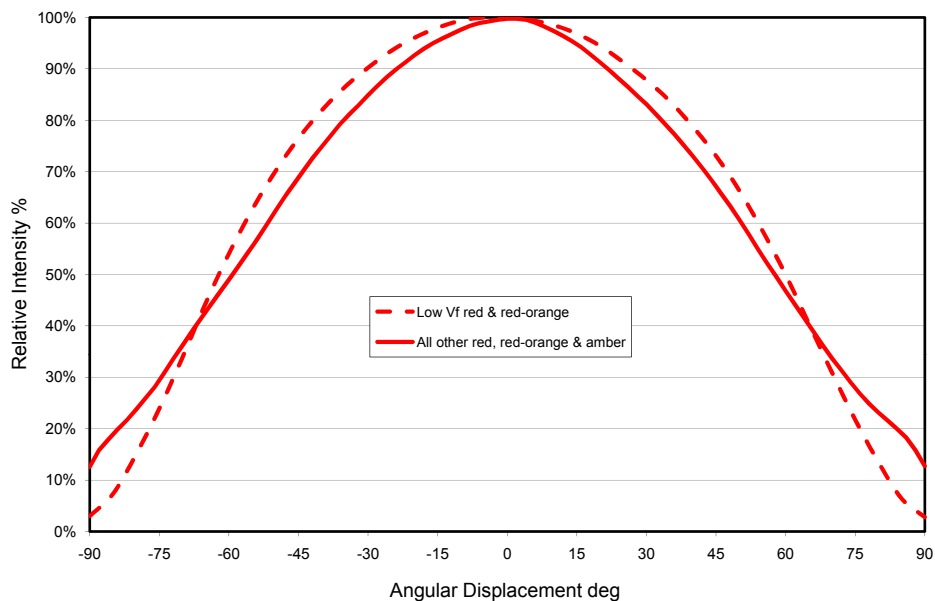

Figure 20. Typical spatial radiation pattern for red, red-orange and amber lambertian.

Typical Polar Radiation Pattern for Red, Red-Orange and Amber Lambertian

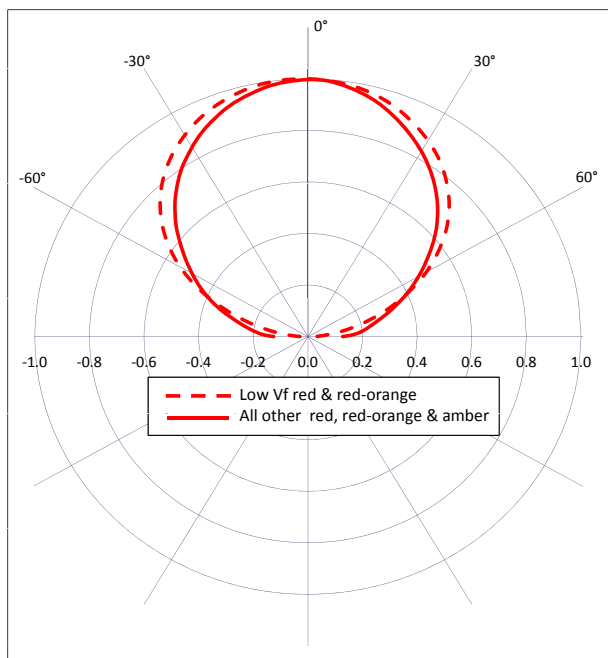

Figure 21. Typical polar radiation pattern for red, red-orange and amber lambertian.

Emitter Pocket Tape Packaging

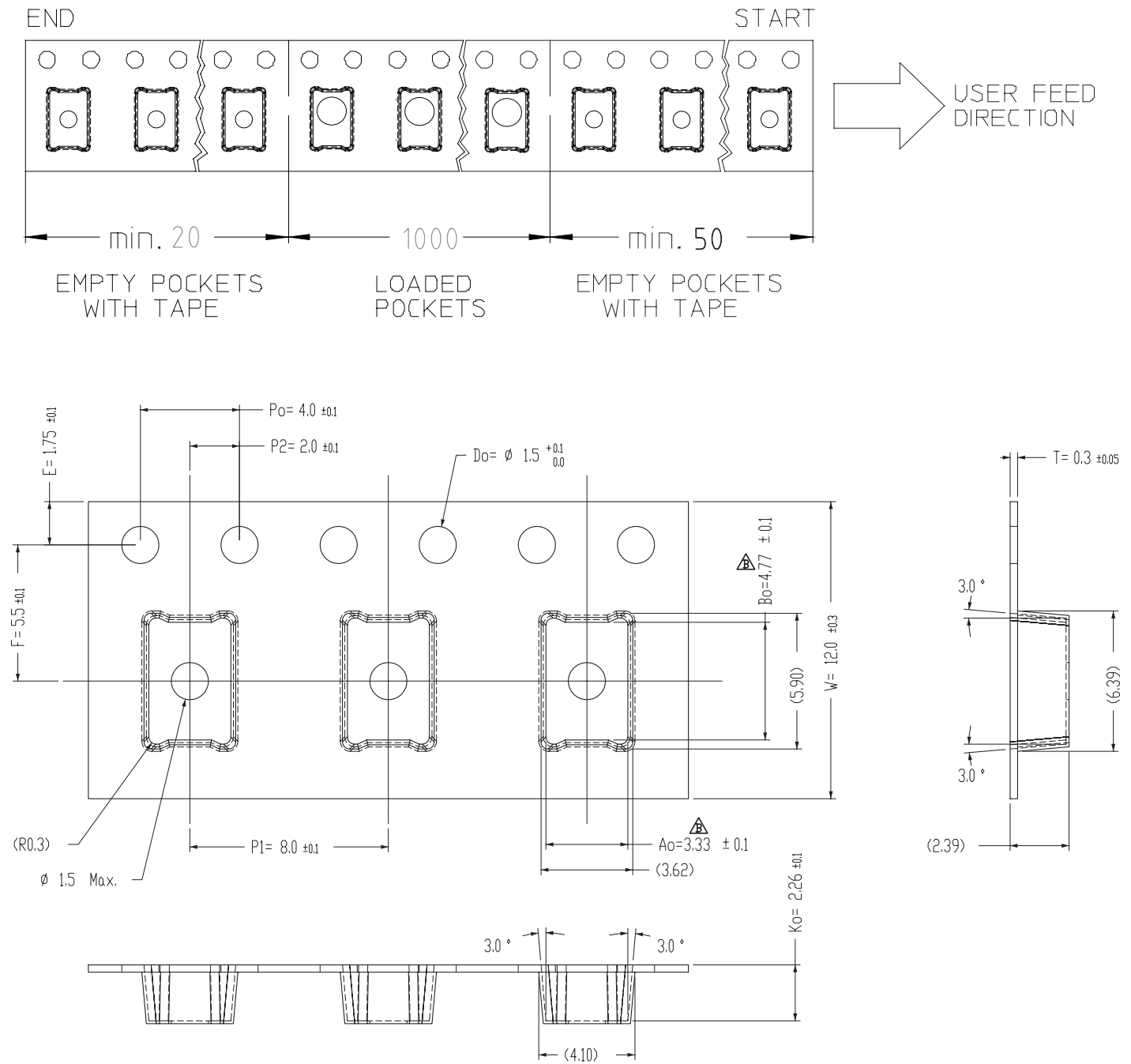

Figure 22. Emitter pocket tape packaging.

Emitter Reel Packaging

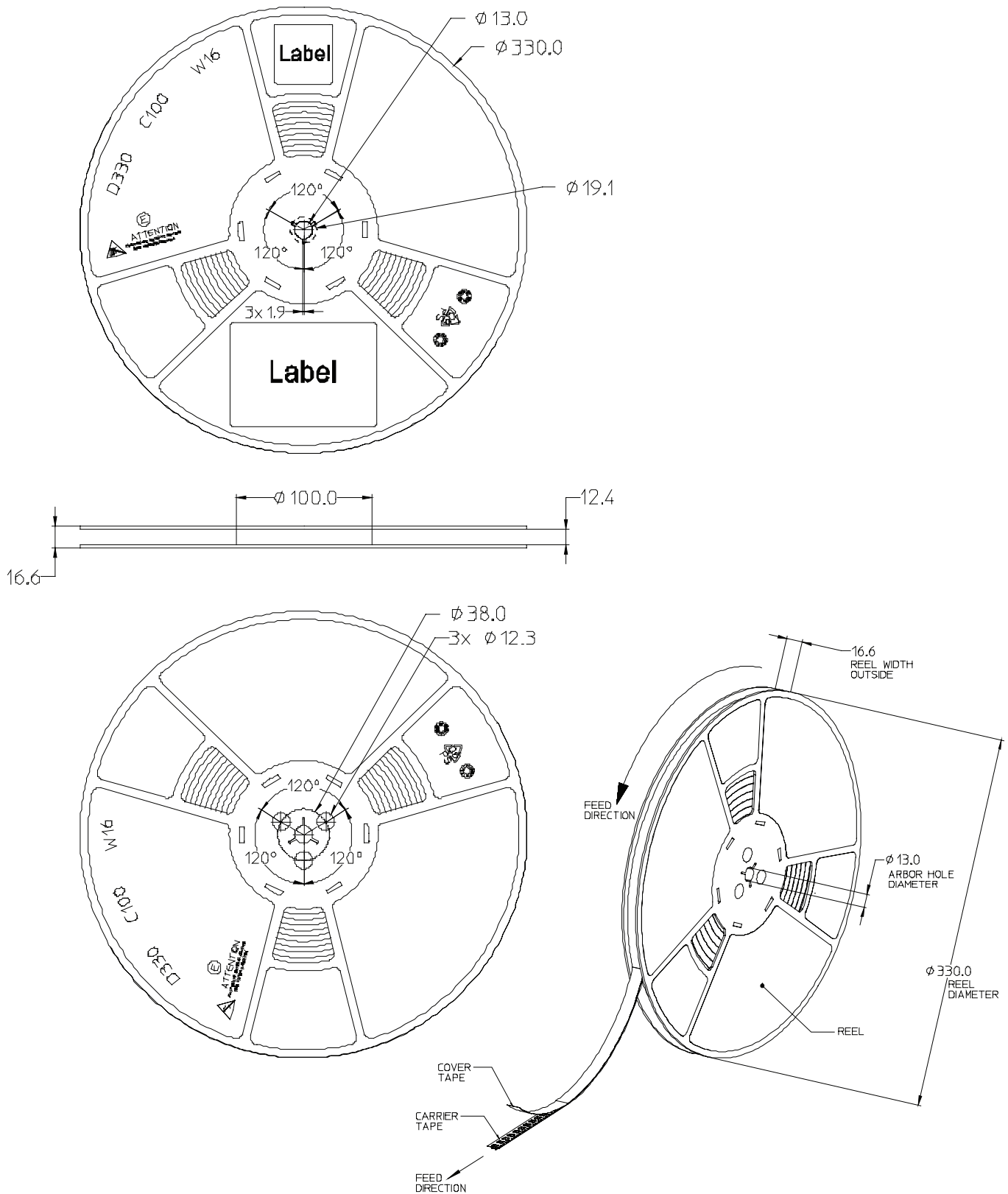

Figure 23. Emitter reel packaging.

Product Binning and Labeling

Purpose of Product Binning

In the manufacturing of semiconductor products, there is a variation of performance around the average values given in the technical data sheets. For this reason, Philips Lumileds bins the LED components for luminous flux, color and forward voltage (V_f).

Decoding Product Bin Labeling

LUXEON Rebel emitters are labeled using a three or four digit alphanumeric code (CAT code) depicting the bin values for emitters packaged on a single reel. All emitters packaged within a reel are of the same 3-variable bin combination. Using these codes, it is possible to determine optimum mixing and matching of products for consistency in a given application.

Format of Labeling for Emitters

Reels of Green, Cyan, Blue, Royal-Blue, Red, Red-Orange and Amber emitters are labeled with a three digit alphanumeric CAT code following the format below.

ABC

A = Flux bin (J, K, L, M etc.)

B = Color bin (2, 4, 6 etc.)

C = V_f bin (D, E, F, G etc.)

Luminous Flux Bins

Table 8 lists the standard photometric luminous flux bins for LUXEON Rebel Direct Color emitters (tested and binned at 350 mA). Although several bins are outlined, product availability in a particular bin varies by production run and by product performance. Not all bins are available in all colors.

Table 8.

Flux Bins All Colors (except Royal-Blue)		
Bin Code	Minimum Photometric Flux (lm)	Maximum Photometric Flux (lm)
A	8.2	10.7
B	10.7	13.9
C	13.9	18.1
D	18.1	23.5
E	23.5	30
F	30	40
G	40	50
H	50	60
J	60	70
K	70	80
L	80	90
M	90	100
N	100	120
P	120	140
Q	140	160
R	160	180

Table 9.

Flux Bins Royal-Blue Only (tested and binned at 350 mA)		
Bin Code	Minimum Radiometric Flux (mW)	Maximum Radiometric Flux (mW)
A	175	225
B	225	275
C	275	350
D	350	425
E	425	500
F	500	600
G	600	700
H	700	800
J	800	900
K	900	1000

Forward Voltage Bins

Table 10 lists minimum and maximum V_f bin values per emitter. Although several bins are outlined, product availability in a particular bin varies by production run and by product performance.

Table 10.

V_f Bins			
Bin Code	Minimum Forward Voltage (V)	Maximum Forward Voltage (V)	
A	2.31	2.55	
B	2.55	2.79	
C	2.79	3.03	
D	3.03	3.27	
E	3.27	3.51	
F	3.51	3.75	
G	3.75	3.99	
V	1.80	2.00	
W	2.00	2.20	
X	2.20	2.40	
Y	2.40	2.60	
Z	2.60	2.80	

Color Bins

Green, Cyan and Blue LUXEON Rebel Direct Color emitters are tested and binned for dominant wavelength.

Dominant Wavelength Bin Structure for Green Emitters

Table 11.

Bin Code	Minimum Dominant Wavelength (nm)	Maximum Dominant Wavelength (nm)
1	520	525
2	525	530
3	530	535
4	535	540
5	540	545
6	545	550

Dominant Wavelength Bin Structure for Cyan Emitters

Table 12.

Bin Code	Minimum Dominant Wavelength (nm)	Maximum Dominant Wavelength (nm)
1	490	495
2	495	500
3	500	505
4	505	510
5	510	515
6	515	520

Dominant Wavelength Bin Structure for Blue Emitters

Table 13.

Bin Code	Minimum Dominant Wavelength (nm)	Maximum Dominant Wavelength (nm)
1	460	465
2	465	470
3	470	475
4	475	480
5	480	485
6	485	490

Royal-Blue LUXEON Rebel Direct Color emitters are tested and binned for peak wavelength.

Peak Wavelength Bin Structure for Royal-Blue Emitters

Table 14.

Bin Code	Minimum Peak Wavelength (nm)	Maximum Peak Wavelength (nm)
3	440	445
4	445	450
5	450	455
6	455	460

Red, Red-Orange and Amber LUXEON Rebel Direct Color emitters are tested and binned for dominant wavelength.

Dominant Wavelength Bin Structure for Red Emitters

Table 15.

Bin Code	Minimum Dominant Wavelength (nm)	Maximum Dominant Wavelength (nm)
4	620.0	630.0
5	630.0	645.0

Dominant Wavelength Bin Structure for Red-Orange Emitters

Table 16.

Bin Code	Minimum Dominant Wavelength (nm)	Maximum Dominant Wavelength (nm)
2	610.0	620.0

Dominant Wavelength Bin Structure for Amber Emitters

Table 17.

Bin Code	Minimum Dominant Wavelength (nm)	Maximum Dominant Wavelength (nm)
1	584.5	587.0
2	587.0	589.5
4	589.5	592.0
6	592.0	594.5
7	594.5	597.0

Company Information

Philips Lumileds is a leading provider of power LEDs for everyday lighting applications. The company's records for light output, efficacy and thermal management are direct results of the ongoing commitment to advancing solid-state lighting technology and enabling lighting solutions that are more environmentally friendly, help reduce CO₂ emissions and reduce the need for power plant expansion. Philips Lumileds LUXEON® LEDs are enabling never before possible applications in outdoor lighting, shop lighting, home lighting and automotive lighting.

Philips Lumileds is a fully integrated supplier, producing core LED material in all three base colors, (Red, Green, Blue) and white. Philips Lumileds has R&D centers in San Jose, California and in the Netherlands, and production capabilities in San Jose, Singapore and Penang, Malaysia. Founded in 1999, Philips Lumileds is the high flux LED technology leader and is dedicated to bridging the gap between solid-state technology and the lighting world. More information about the company's LUXEON LED products and solid-state lighting technologies can be found at www.philipslumileds.com.

www.philipslumileds.com
www.philipslumileds.cn.com
www.futurelightingsolutions.com

For technical assistance or the location of your nearest sales office contact any of the following:

North America:
1 888 589 3662
americas@futurelightingsolutions.com

Europe:
00 800 443 88 873
europe@futurelightingsolutions.com

Asia Pacific:
800 5864 5337
asia@futurelightingsolutions.com

Japan:
800 5864 5337
japan@futurelightingsolutions.com

©2010 Philips Lumileds Lighting Company. All rights reserved.
Product specifications are subject to change without notice.
LUXEON is a registered trademark of the Philips Lumileds Lighting Company in the United States and other countries.

PHILIPS
LUMILEDS