

selector

product selector guide

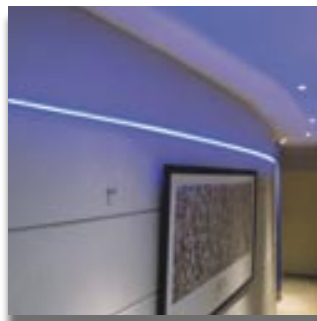

CML has lead the world of illumination since its formation in 1910, moving forward almost 100 years CML-IT is now a combination of several of the world most successful lighting companies.... With a worldwide manufacturing base CML-IT is able to provide local production supported by 1st class Engineering support. Moving from the supply of Incandescent lamps CML-IT embraced LED technology and is now one of the world leading suppliers of both LEDs and LED based solutions for a variety of markets as diverse as Architecture,Transport, Automotive, Gaming & Entertainment. Working with some of the world greatest OEM's in their fields CML-IT can guarantee a world class solution.

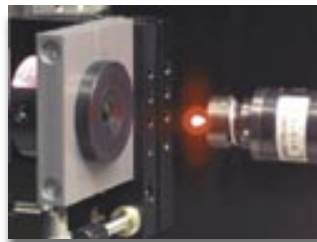

PowerLEDs	4
LEDs	5
CBIs	6 - 7
Light pipes	8
LEDules 1	9
LEDules 2	10
Newport & Sydney	11
LED Drivers / Power Supplies	12
Accentios	13
Light Engines	14
Light Guides	15
Star LEDs	16
MultiLEDs	17
Panel Mount Indicators	18 - 19
T5 / T10 WB Based LEDs	20
MFB	21
Lamps	22
Neon Lamps	23
Socketed Lamps	24
Sockets	25
Aviation Lamps	26 - 27
Aviation Fluorescent Lamps	28
CCFL & Inverters	29
Xenon Lamps, Sockets & Sixcess Lamps	30
Color Ray	31
Traffic Lights	32
Provision	33



POWERLEDS



INDUSTRIAL LAMPS



LEDULES 1



LEDULES 2

AVIATION FLUORESCENT TUBES & LAMPS



SYDNEY

LIGHT PIPES



CIRCUIT BOARD INDICATORS



LED / LAMP INDICATORS



ACSENTIOS

LIGHT GUIDES

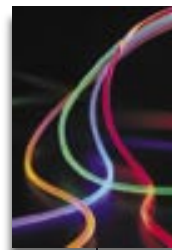

XENON LAMPS



LIGHT ENGINES



T5/T10 WB BASED LEDs



COLD CATHODES



The listing below contains generic product information.

Please visit our Website at www.cml-it.com for a more detailed listing of product specifications.

	Series Numbers	Size	Pure White	Warm White	Red	Green	Amber	Blue	Cyan	Full Color (RGB)	1W	2.5W	5W	3 x 1W
	CMDA30 CMDA36 CMDA51	9x9x4mm	●	●	●	●	●	●	●	-	●	●	●	-
	CMDA31 CMDA37 CMDA52	9x9x4mm on Star PCB	●	●	●	●	●	●	●	-	●	●	●	-
	CMDA32 CMDA38 CMDA53	9x9x4mm on Square PCB	●	●	●	●	●	●	●	-	●	●	●	-
	CMDA33 CMDA39 CMDA54	9x9x7.65mm	●	●	●	●	●	●	●	-	●	●	●	-
	CMDA34 CMDA40 CMDA55	9x9x7.65mm on Star PCB	●	●	●	●	●	●	●	-	●	●	●	-
	CMDA35 CMDA41 CMDA56	9x9x7.65mm on Square PCB	●	●	●	●	●	●	●	-	●	●	●	-
	CMDA42 CMDA48	Ø8x5.55mm	●	●	●	●	●	●	●	-	●	●	-	-
	CMDA43 CMDA49	Ø8x5.55mm on Star PCB	●	●	●	●	●	●	●	-	●	●	-	-
	CMDA44 CMDA50	Ø8x5.55mm on Square PCB	●	●	●	●	●	●	●	-	●	●	-	-
	CMDA30RGB	9x9x4mm	-	-	-	-	-	-	-	●	-	-	-	●
	CMDA31RGB	9x9x4mm on Star PCB	-	-	-	-	-	-	-	●	-	-	-	●
	CMDA59RGB	Ø8x2.3mm	-	-	-	-	-	-	-	●	-	-	-	●

● standard ○ available on request — please contact our sales representative



CML IT is a world leader in the manufacturing of LEDs and LED assemblies. CML offers a wide variety of products utilizing LEDs as a light source. Our line of discrete LEDs consists of both through hole and SMT products in all of the standard industry sizes including 3mm, 5mm, 0603, 0805, 1206, PLCC and many others. All CML IT LEDs are available off-the-shelf in a wide variety of colors and intensities. The listing below contains generic product information.

Please visit our Website at www.cml-it.com for a more detailed listing of product specifications.

Image	Package	Series Number	RED			ORANGE	AMBER	YELLOW	GREEN			BLUE	WHITE	BI COLOR		TRI COLOUR	Intensity Range (mcd)	Viewing angle range (°)	
			GaP (700)	GaAlAs (680)	GaAsP (635)	AlInGaP (624-630)	AlInGaP (605-615)	GaAsP (605)	AlInGaP (590)	GaAsP (585)	AlInGaP (571-574)	GaP (555-565)	InGaN (505-525)	InGaN (466-470)	SiC (430)	InGaN			Red/Green
	Right Angle	CMD12-21 CMD11504	●	●	●	●	●	●	●	●	●	●	●	●	●	●	●	1.5 - 230	20 - 130
	PLCC	CS 100 CMD67-21 CMD67-22	●	●	●	●	●	●	●	●	●	●	●	●	●	●	●	2.5 - 700	60 - 130
	0603	CS010 CMDA19 CMDA6	●	●	●	●	●	●	●	●	●	●	●	●	●	●	●	1.4 - 200	70 - 170
	0805	CS020 CMDA5 CMD17-21	●	●	●	●	●	●	●	●	●	●	●	●	●	●	●	1 - 200	30 - 170
	1206	CS025 CMDA2 CMD15-21	●	●	●	●	●	●	●	●	●	●	●	●	●	●	●	0.7 - 460	20 - 170
	1208	7016X	●	●	●	●	●	●	●	●	●	●	●	●	●	●	●	2.2 - 25	110
	1210	7011X	-	-	-	-	-	-	-	-	-	-	-	-	●	●	-	3 - 100	60 - 140
	Gull Wing	CMD28-21	●	●	●	●	●	●	●	●	●	●	●	●	●	●	●	0.1 - 40	125 - 150
	Bright Angle	6200 6255	●	●	●	●	●	●	●	●	●	●	●	●	-	-	-	0.5 - 10	25
	Gull Wing	CMD91-21/TR7 CMD95-21/TR7	●	●	●	●	●	●	●	●	●	●	●	●	-	-	-	11.5 - 2300	25 - 150
	Yoke Bend	CMD91-21/TR9 CMD95-21/TR9	●	●	●	●	●	●	●	●	●	●	●	●	-	-	-	11.5 - 2300	25 - 150
	Z-Bend	CMD91-21/TR10 CMD95-21/TR10	●	●	●	●	●	●	●	●	●	●	●	●	-	-	-	11.5 - 2300	25 - 150
	SOT-23	CS130	-	●	●	-	-	-	●	●	●	-	-	-	-	-	-	5 - 100	140
	5mm Discrete LED	CT501 43xxH CMDxxx	-	●	●	●	●	●	●	●	●	●	●	●	●	●	●	0.1 - 14000	12 - 100
	3mm Discrete LED	CT301 43xxF CMDxx	-	●	●	●	●	●	●	●	●	●	●	●	●	●	●	0.3 - 11000	16 - 180
	Rectangular LED	CMD5-124	-	-	●	-	-	-	●	●	-	-	-	●	-	-	-	1 - 6	100
	Rectangle LED	43xxR 43xxD	-	-	●	-	-	●	-	●	-	-	-	●	●	-	-	1 - 20	100 - 150
	5mm 3 led LED	CMD339	-	-	-	-	-	-	-	-	-	-	-	-	●	●	-	1-5	7
		4361H	-	-	-	-	-	-	-	-	-	-	-	-	●	●	-	1.5 - 50	54 - 75
	3mm 3 led LED	4361L	-	-	-	-	-	-	-	-	-	-	-	-	●	-	-	4 - 12	60 - 70
	3mm flat top 3 led LED	4361M	-	-	-	-	-	-	-	-	-	-	-	-	●	-	-	20 - 4	60 - 70
	1.8 x 5.3 3 led LED	4362D	-	-	-	-	-	-	-	-	-	-	-	-	●	-	-	0.25 - 4.5	60 - 100

● standard ○ available on request - please contact our sales representative



CML IT LED Assemblies are available in both right angle and vertical package and utilize the CML-IT line of high quality LEDs. Parts range in voltage from 2V to 12V and in current from 2mA to 20mA. The UL 94V0 housings ensure proper LED alignment. The listing below contains generic product information.

Please visit our Website at www.cml-it.com for a more detailed listing of product specifications.

Package	Series Number	RED				ORANGE	AMBER	YELLOW		GREEN		BLUE		WHITE	BI COLOR		Intensity Range (mcd)	Low Current	Integral Resistor
		GaP (700)	GaAlAs (660)	GaAsP (635)	AlInGaP (630)	AlInGaP (610)	GaAsP (605)	AlInGaP (590)	GaAsP (585)	AlInGaP (574)	GaP (555-565)	InGaN (505-525)	InGaN (470)	SiC (430)	InGaN	Red/Green			
	5300	●	●	●	●	●	●	●	●	●	●	●	●	●	●	●	2.0 - 160	●	●
	5341	●	●	●	●	●	●	●	●	●	●	●	●	●	●	●			
	5300	●	●	●	●	●	●	●	●	●	●	●	●	●	●	●	2.0 - 160	●	●
	5306	●	●	●	●	●	●	●	●	●	●	●	●	●	●	●			
	5640	●	●	●	●	●	●	●	●	●	●	●	●	●	●	●	2.0 - 160	●	●
	5390	●	●	●	●	●	●	●	●	●	●	●	●	●	●	●	2.0 - 160	●	●
	5670	●	●	●	●	●	●	●	●	●	●	●	●	●	●	●	2.0 - 160	●	●
	5610	●	●	●	●	●	●	●	●	●	●	●	●	●	●	●	1.8 - 60	●	●
	5311	●	●	●	●	●	●	●	●	●	●	●	●	●	●	●			
	5321	●	●	●	●	●	●	●	●	●	●	●	●	●	●	●	1.8 - 60	●	●
	5322	●	●	●	●	●	●	●	●	●	●	●	●	●	●	●	1.8 - 60	●	●
	5600	●	●	●	●	●	●	●	●	●	●	●	●	●	●	●	1.8 - 60	●	●
	5320	●	●	●	●	●	●	●	●	●	●	●	●	●	●	●			
	5365	●	●	●	●	●	●	●	●	●	●	●	●	●	●	●	1.8 - 60	●	●
	5360	●	●	●	●	●	●	●	●	●	●	●	●	●	●	●	1.8 - 60	●	●
	5324	●	●	●	●	●	●	●	●	●	●	●	●	●	●	●			
	5324	●	●	●	●	●	●	●	●	●	●	●	●	●	●	●	1.8 - 60	●	●
	5326	●	●	●	●	●	●	●	●	●	●	●	●	●	●	●	1.8 - 60	●	●
	5680	●	●	●	●	●	●	●	●	●	●	●	●	●	●	●	1.8 - 60	●	●
	553-	●	●	●	●	●	●	●	●	●	●	●	●	●	●	●			
	5681	●	●	●	●	●	●	●	●	●	●	●	●	●	●	●	1.8 - 60	●	●
	5684	●	●	●	●	●	●	●	●	●	●	●	●	●	●	●	1.8 - 60	●	●
	5693	●	●	●	●	●	●	●	●	●	●	●	●	●	●	●	1.8 - 60	●	●
	5694	●	●	●	●	●	●	●	●	●	●	●	●	●	●	●	1.8 - 60	●	●

● standard ○ available on request — please contact our sales representative



CML IT LED Assemblies are available in both right angle and vertical package and utilize the CML IT line of high quality LEDs. Parts range in voltage from 2V to 12V and in current from 2mA to 20mA. The UL 94V0 housings ensure proper LED alignment. The listing below contains generic product information.

Please visit our Website at www.cml-it.com for a more detailed listing of product specifications.

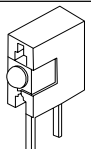
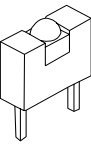
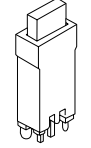
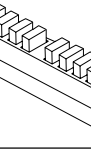
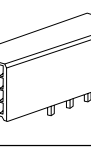
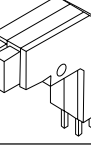
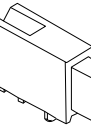
Package	Series Number	RED			ORANGE	AMBER	YELLOW		GREEN		BLUE	WHITE	BI COLOR		Intensity Range (mcd)	Low Current	Integral Resistor		
		Gap (700)	GaAlAs (660)	GaAsP (635)	AlInGaP (630)	AlInGaP (610)	GaAsP (605)	AlInGaP (590)	GaAsP (585)	AlInGaP (574)	Gap (555-565)	InGaN (505-525)	InGaN (470)	SiC (430)				InGaN	Red/Green
	2mm Rt Angle	5350	-	●	●	●	-	-	●	●	●	-	-	-	-	0.5 - 5	●	●	
	2mm Vertical	5370	-	●	●	●	-	-	●	●	-	-	-	-	0.5 - 5	●	●		
	Rectangle Vertical	5610	-	●	●	●	-	-	●	●	●	-	-	-	●	●	1 - 16	●	-
		5630	-	●	●	●	-	-	●	●	●	-	-	-	-	●	●	1 - 16	●
	Rectangle Vertical Array	5638	-	●	●	●	-	-	●	●	●	-	-	-	●	●	1 - 16	-	-
	Rectangle Rt Angle Quad Level	5894	-	●	●	●	-	-	●	●	●	-	-	-	●	●	1 - 16	-	-
		5994	-	●	●	●	-	-	●	●	●	-	-	-	-	●	●	1 - 16	-
	Rectangle Rt Angle Two Array	5632	-	●	●	●	-	-	●	●	●	-	-	-	●	●	1 - 16	-	-
	Rectangle Rt Angle	5636	●	-	●	-	-	●	-	●	-	-	-	-	-	1 - 16	-	-	
		5635	●	-	●	-	-	●	-	●	-	-	-	-	-	1 - 16	-	-	

● standard ○ available on request — please contact our sales representative

Light pipes



Bright•Pipes™ Optical Lightpipes produce bright, even indication based on optical ray tracing. They conveniently and economically propagate light from SMT LEDs through angles and distances to a viewable front lens surface in order to provide an attractive, bright and even indication of equipment of function status with a minimal attenuation of light output through the optical fibers that join the base, at the LED light source, to the lens front. Custom engineered Bright•Pipes™ Optical Lightpipes for specialized applications are in constant development. The listing below contains generic product information.

Please visit our Website at www.cml-it.com for a more detailed listing of product specifications.

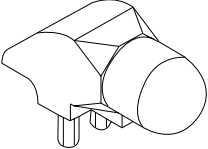
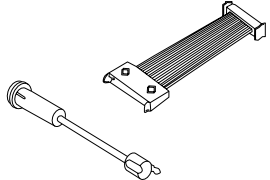
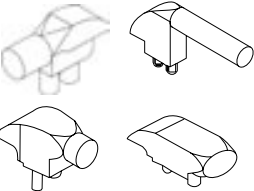
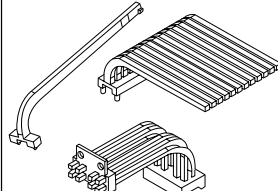
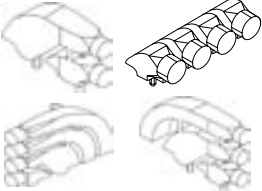
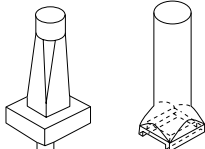
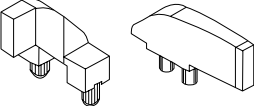
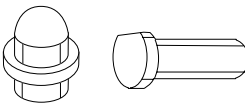
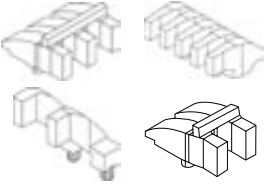
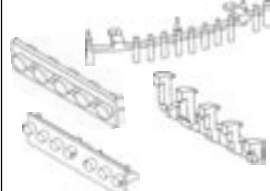
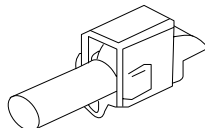
	7511 series	Right Angle 5mm		7512 series	Flexible Light Pipes
	7511 series	Right Angle 3mm		7511 series	Over Jack Style
	7511 series	Right Angle 3mm, Multiple Position		7511 series	Vertical
	7511 series	Right Angle Rectangular		7511 series	Panel Mount
	7511 series	Right Angle Rectangular Multiple Position		7511 series	Miscellaneous And Custom
				7520 series	Surface Mount



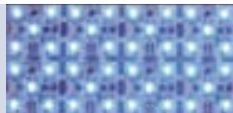

CML IT LED Modules are available in various sizes, shapes and colors and utilize the CML IT line of high quality LEDs. The features are easy handling, compact construction, long life span and low maintenance cost, constant current regulation and no IR & UV radiation. The listing below contains generic product information.

Please visit our Website at www.cml-it.com for a more detailed listing of product specifications.

		Series Numbers	Size	Red	Amber	Yellow	Orange	Green	Blue	Cyan	Cool White	Warm White	RGB	Radiance Angle Range (degree)	Mounted LEDs	Lum. Flux	Voltage
	Array Module	LM-Axxx-1x1	30 x 30 mm	●	—	●	●	●	●	—	●	—	—	120°	5 LEDs (G, B, W) 9 LEDs (R, Y, O)	210 - 720 mod per LED	24 VDC
		LM-Axxx-2x2	60 x 60 mm	●	—	●	●	●	●	—	●	—	—	120°	20 LEDs (G, B, W) 36 LEDs (R, Y, O)	210 - 720 mod per LED	24 VDC
		LM-Axxx-2x4	60 x 120 mm	●	—	●	●	●	●	—	●	—	—	120°	40 LEDs (G, B, W) 72 LEDs (R, Y, O)	210 - 720 mod per LED	24 VDC
		LM-Axxx-6x12	180 x 360 mm	●	—	●	●	●	●	—	●	—	—	120°	360 LEDs (G, B, W) 648 LEDs (R, Y, O)	210 - 720 mod per LED	24 VDC
	Bar Module	LM-Bxxx-1	200 x 10 mm	●	—	●	●	●	●	—	●	—	—	120°	18 LEDs	210 - 720 mod per LED	24 VDC
		LM-Bxxx-2	400 x 10 mm	●	—	●	●	●	●	—	●	—	—	120°	36 LEDs	210 - 720 mod per LED	24 VDC
	Flex-Bar-Module	LM-FB26x	364 x 10 mm	●	—	●	—	●	●	—	●	—	—	120°	26	200 - 850 mod per LED	10 VDC
		LM-FB26x-12	364 x 10 mm	●	—	●	—	●	●	—	●	—	—	120°	26	60 - 850 mod per LED	12 VDC
		LM-FB20F-12	400 x 15 mm	—	—	—	—	—	—	—	—	—	●	100°	20	1.5 / 3.5 / 2.3 lm per 4 LEDs	12 VDC
	Circle Module	LM-Cxxx	45 mm diameter	●	—	●	●	●	●	—	●	—	—	120°	10 LEDs (G, B, W) 18 LEDs (R, Y, O)	210 - 640 mod per LED	24 VDC
	Hi-Flux Channel Letter Module Strip Module 1	9520CL-xxx	25 x 25 mm (1 x 1 inches)	●	●	—	●	●	●	●	●	—	—	120°	1 per Module	32 - 160 lm	1.8 - 2.6 VDC 3.0 - 4.1 VDC
	Hi-Brite Channel Letter Module Strip Module 4	9500CL-xxx	30 x 30 mm (1.18 x 1.18 inches)	●	●	—	●	●	●	●	●	—	—	120°	4 per Module	3 - 25	9.0 - 14.0 VDC
	TransLED-Module	CM-200LM012-xxx	65 x 62 mm	●	●	—	●	●	●	●	●	—	—	120°	12	90 - 480 lm	8.0 - 10.4 VDC 12.0 - 16.4 VDC
		CM-200LM018-xxx	65 x 62 mm	●	●	—	●	●	●	●	●	●	—	—	120°	18	140 - 710 lm

● standard ○ available on request — please contact our sales representative



CML IT LED Modules are available in various sizes, shapes and colors and utilize the CML IT line of high quality LEDs. The features are easy handling, compact construction, long life span and low maintenance cost, constant current regulation and no IR & UV radiation. The listing below contains generic product information.



Please visit our Website at www.cml-it.com for a more detailed listing of product specifications.

		Series Number	Size	Red	Amber	Green	Blue	Cyan	Cool White	Warm White	Filtered Warm White	RGB	Radiance Angle Range (degree)	Mounted LEDs per Module	Lum. Flux	Power consumption	max current consumption	Voltage
	Power Strip-Module 8W	ILL2A0005x	302 x 13 mm	●	●	●	●	●	●	●	—	—	120°	6 x 1W	72 - 264 lm	8W	350 mA	
	LED Comp-Module 5°	ILL5A0002x	Ø 44.2 x 17 mm	●	●	●	●	●	●	●	●	—	5°	1 x 3W	19 - 64 lm	3W	250 - 325 mA	10-30 VDC
	LED Comp-Module 25°			●	●	●	●	●	●	●	●	●	—	25°	1 x 3W	19 - 64 lm	3W	250 - 325 mA
	LED Power Module Round 3W 5°	ILL3A0001x	Ø 44.2 x 15.3 mm	●	●	●	●	●	●	●	—	—	5°	1 x 3W	19 - 64 lm	3W	700 mA	
	LED Power Module Round 3W 25°			●	●	●	●	●	●	●	●	—	—	25°	1 x 3W	19 - 64 lm	3W	700 mA
	LED Power Module Round 4W 11°	ILL3A0003x	Ø 32.5 x 17 mm	●	●	●	●	●	●	●	—	—	11°	3 x 1W	29 - 105 lm	4W	350 mA	
	LED Power Module Round 4W 24°			●	●	●	●	●	●	●	●	—	—	24°	3 x 1W	29 - 105 lm	4W	350 mA
	LED Power Module Round 9W 6°	ILL3A0004x	Ø 38.1 x 15.4 mm	●	●	●	●	●	●	●	—	—	6°	3 x 3W	57 - 192 lm	9W	700 mA	
	LED Power Module Round 9W 25°			●	●	●	●	●	●	●	●	—	—	25°	3 x 3W	57 - 192 lm	9W	700 mA
	LED Power Module Round 14W 6°	ILL3A0002x	Ø 44.2 x 15.3 mm	●	●	●	●	●	●	●	—	—	6°	5 x 3W	95 - 320 lm	14W	700 mA	
	LED Power Module Round 14W 25°			●	●	●	●	●	●	●	●	—	—	25°	5 x 3W	95 - 320 lm	14W	700 mA

● standard ○ available on request — please contact our sales representative



Please visit our Website at www.cml-it.com for a more detailed listing of product specifications.

		Series Number	Size	Red	Amber	Green	Blue	Cyan	Cool White	Warm White	Filtered Warm White	Power consumption	Radiance Angle Range (degree)	Luminous Flux	Voltage
	Newport	ILL5A0001x	Ø 60 x 36 mm	●	●	●	●	●	●	●	●	3W	40°		10 - 30 VDC
	Sydney		Ø 55 mm							●		4W			10 - 30 VDC

● standard ○ available on request — please contact our sales representative



Please visit our Website at www.cml-it.com for a more detailed listing of product specifications.

		Series Numbers	Size	Voltage input	Voltage output	Power output	Current output	Suggested application
	LED Driver	CMPS1215S	74 x 54 x 22 mm	187 - 264 VAC	12 VDC	15 W	1,25 A	LM-FB-12 Series
		CMPS2415S		187 - 264 VAC	24 VDC	15 W	0,65 A	LM-A LM-B LM-C Module - Series
	LED Driver	SL-DRV-12	40 x 40 x 22 mm	90 - 250 VAC	12 VDC	3 Watts	0,25 A	LM-FB-12 and LEDules II -Series
		CMPSCC700S		90 - 250 VAC	constant current regulated	3 Watts	700 mA max	Light Engine 8570LE-series
	Power Supply	CMPS1260S	170 x 95 x 37.5 mm	187 - 264 VAC	12 VDC	70 W	6,0 A	For higher quantities of LEDules I and LEDules II
		CMPS2460S		187 - 264 VAC	24 VDC	70 W	3,0 A	For higher quantities of LEDules I and LEDules II



Please visit our Website at www.cml-it.com for a more detailed listing of product specifications.

		Series Numbers	Size	Gap	Clear Lens	Satin Lens	12 VDC Bi-polar	24 VDC Bi-polar	130 VAC	240 VAC	Mounted LEDs
	Accentio Red	CMLxxxRS	Ø 75 x 25 mm	GX53	—	●	●	●	●	●	21
		CMLxxxRC		GX53	●	—	●	●	●	●	21
	Accentio Green	CMLxxxGS	Ø 75 x 25 mm	GX53	—	●	●	●	●	●	21
		CMLxxxGC		GX53	●	—	●	●	●	●	21
	Accentio Yellow	CMLxxxYS	Ø 75 x 25 mm	GX53	—	●	●	●	●	●	21
		CMLxxxYC		GX53	●	—	●	●	●	●	21
	Accentio Blue	CMLxxxBS	Ø 75 x 25 mm	GX53	—	●	●	●	●	●	21
		CMLxxxBC		GX53	●	—	●	●	●	●	21
	Accentio White	CMLxxxWS	Ø 75 x 25 mm	GX53	—	●	●	●	●	●	21
		CMLxxxWC		GX53	●	—	●	●	●	●	21
	GX53 Lamp Holder	CMLGX53xx	Ø 78.8 x 9.9 mm	GX53			●	●	●	●	
			Ø 75.8 x 5.75 mm	GX53			●	●	●	●	

● standard ○ available on request — please contact our sales representative





Please visit our Website at www.cml-it.com for a more detailed listing of product specifications.

Light Engine types	Fits Rigid Light Guide and Side Light Cable sizes	Series Numbers	Red	Green	Amber	Blue	White	Luminous Flux (Lumens) or Luminous Intensity (Cd)	Voltage (VDC)	Maximum Current (mA)	Heat Sink
	5 mm 6.5 mm	8510LE15 Series	●	●	●	●	●	10 to 50 Cd	12	50 to 80	no
	10 mm 14 mm	8511LE16 Series	●	●	●	●	●	10 to 50 Cd	12	50 to 80	yes
	10 mm 12 mm 14 mm	8570LE12 Series	●	●	●	●	●	25 to 122 lm	2.5 - 3.4	800	yes

● standard ○ available on request — please contact our sales representative



Please visit our Website at www.cml-it.com for a more detailed listing of product specifications.

Light Guide Type	Series Numbers	Diameters (mm)	Viewing Angle	120 Diffusant	180 Diffusant	400 Diffusant	Lengths
	7530A Series	6.5	60°	—	—	—	up to 2.44 m (8 feet)
		10	90°	—	—	—	up to 1.83 m (6 feet)
		14	60°	—	—	—	up to 1.83 m (6 feet)
	754xSSx Series	5.5	360°	●	●	●	up to 4.57 m (15 feet)
		6.5	360°	●	●	●	up to 4.57 m (15 feet)
		10	360°	●	●	●	up to 4.57 m (15 feet)
		12	360°	●	●	●	up to 4.57 m (15 feet)
		14	360°	●	●	●	up to 4.57 m (15 feet)





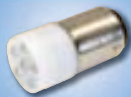















● standard ○ available on request — please contact our sales representative

Star LEDs



CML IT Star LEDs are an effective alternative for based incandescent lamps. Based LEDs have a number of advantages when compared to miniature lamps. Features include a long life expectancy of up to 100,000 hours with low power consumption. Based LEDs are shock and vibration proof and come in a wide variety of colors, styles and voltages. The listing below contains generic product information.

Please visit our Website at www.cml-it.com for a more detailed listing of product specifications.

	Series Number	Size	Base Type	Number of LEDs	Red	Green	Yellow	Blue	White	Flashing	Low voltage DC (24V, 28V)	Low voltage AC/DC (24V, 28V)	High voltage DC (130V)	High voltage AC (130V, 230V)	High voltage AC/DC (130V, 230V)	Special voltages
	15015	T-1 (3mm)	Bi-Pin	1	●	●	●	●	●	-	-	●	-	-	-	○
	15095	T-1 3/4 (6mm)	Bi-Pin	1	●	●	●	●	●	-	-	●	-	-	-	○
	15041	T5.5k	-	1	●	●	●	●	●	-	-	●	-	-	-	○
	15051	T5.5	-	1	●	●	●	●	●	-	-	●	-	-	-	○
	15071	T6.8	-	1	●	●	●	●	●	-	-	●	-	-	-	○
	15086	T-2 (7mm)	PSB	1	●	●	●	●	●	-	-	●	-	-	-	○
	15087	T-2 (7mm)	ESB	1	●	●	●	●	●	-	-	●	-	-	-	○
	15101	T-1 3/4 (6mm)	MF SX6s	1	●	●	●	●	●	-	●	-	-	-	-	○
	1511A 1511E*	T-1 1/2 (5mm)	WB W2x4.6d	1	●	●	●	●	●	-	●*	●	-	-	-	○
	1511B 1511F*	T-3 1/4 (10mm)	WB W2.1x9.5d	1	●	●	●	●	●	-	●*	●	-	-	-	○
	15121	T-1 3/4 (6mm)	MG S5.7s	1	●	●	●	●	●	-	-	●	-	-	-	○
	15161	T-2 (7x20mm)	BA7s	1	●	●	●	●	●	-	-	●	-	-	-	○
	18600* 18606*** 18608**	T-3 1/4 (10x25mm)	BA9s	1 or 3	●	●	●	●	●	-	-	●*	●**	●***	-	○
	18601* 18607*** 18609**	T-3 1/4 (10x25mm)	E10	1 or 3	●	●	●	●	●	-	-	●*	●**	●***	-	○
	18630* 18631** (18640)* (18641)**	T-5 (16x35mm)	BA15d	3 or 6	●	●	●	●	●	-	-	●*	-	-	●**	○
	18633* 18634** (18643)* (18644)**	T-5 (16x35mm)	BA15s	3 or 6	●	●	●	●	●	-	-	●*	-	-	●**	○
	18636* 18637** (18646)* (18647)**	T-5 (16x35mm)	E14	3 or 6	●	●	●	●	●	-	-	●*	-	-	●**	○
	18580* 18581**	T-6 1/3 (20x46mm)	BA15d	9	●	●	●	●	●	-	-	●*	-	●**	-	○
	18680	11x39mm	-	3	●	●	●	●	●	-	-	●	-	-	-	○











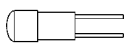

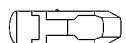

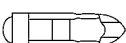
● standard ○ available on request - please contact our sales representative

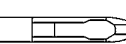
MultiLEDs

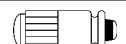
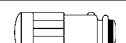

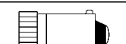
CML IT MultiLEDs are an effective alternative for based incandescent lamps. Based LEDs have a number of advantages when compared to miniature lamps. Features include a long life expectancy of up to 100,000 hours with low power consumption. Based LEDs are shock and vibration proof and come in a wide variety of colors, styles and voltages. The listing below contains generic product information.

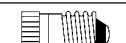
Please visit our Website at www.cml-it.com for a more detailed listing of product specifications.

	Series Number	Size	Base Type	Number of LED Chips	Red	Green	Yellow	Blue	White	Flashing	Low voltage DC (24V, 28V)	Low voltage AC/DC (24V, 28V)	High voltage DC (130V)	High voltage AC (130V, 230V)	High voltage AC/DC (130V, 230V)	Special voltages
	15010 (15012)	T-1 (3mm)	Bi-Pin	4 or 6	●	●	●	-	-	-	●	-	-	-	-	○
	15090 (15091)	T-1 3/4 (6mm)	Bi-Pin	4 or 6	●	●	●	-	-	-	●	-	-	-	-	○
	15020 (15021)	T4.5		4 or 6	●	●	●	-	-	-	●	-	-	-	-	○
	15030 (15031)	T4.6		4 or 6	●	●	●	-	-	-	●	-	-	-	-	○
	15040 (15041)	T5.5k		4 or 6	●	●	●	-	-	-	●	-	-	-	-	○
	15050 (15051)	T5.5		4 or 6	●	●	●	-	-	-	●	-	-	-	-	○
	15080 (15071)	T6.8		4 or 6	●	●	●	-	-	-	●	-	-	-	-	○
	15100 (15101)	T-1 3/4 (6mm)	MF SX6s	4 or 6	●	●	●	-	-	-	●	-	-	-	-	○
	15110* (15112)* (15113)**	T-1 1/2 (5mm)	WB W2x4.6d	4 or 6	●	●	●	-	-	-	●*	●**	-	-	-	○
	15120* (15121)* (15130)**	T-1 3/4 (6mm)	MG S5.7s	4 or 6	●	●	●	-	-	-	●*	●**	-	-	-	○
	15140* (15139)*	T-1 1/2 (5mm)	BA5s	4 or 6	●	●	●	-	-	-	●*	-	-	-	-	○
	15161	T-2 (7mm)	BA7s	6	●	●	●	-	-	-	●	-	-	-	-	○
	18270** 18271*	T-3 1/4 (10x21mm)	BA9s	8	●	●	●	-	-	-	●*	●**	-	-	-	○
	18310** 18311* 18240	T-3 1/4 (10x28mm)	BA9s	8	●	●	●	-	-	●	●*	●**	-	-	-	○
	18290** 18291*	T-3 1/4 (10x21mm)	E10	8	●	●	●	-	-	-	●*	●**	-	-	-	○
	18330** 18331*	T-3 1/4 (10x28mm)	E10	8	●	●	●	-	-	-	●*	●**	-	-	-	○

● standard ○ available on request — please contact our sales representative

Panel Mount Indicators

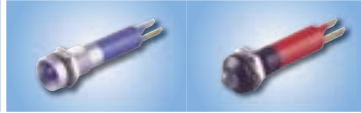

CML IT offers panel mount indicators manufactured with LED, Neon or Incandescent light sources. These indicators are available in a number of different lens and termination styles, with voltages of 2V ~ 250V available off-the-shelf. The listing below contains generic product information.

Please visit our Website at www.cml-it.com for a more detailed listing of product specifications.

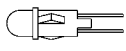
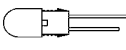
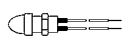
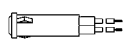
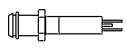
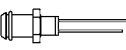
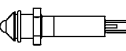
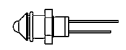
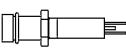
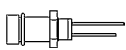
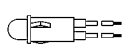
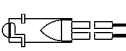
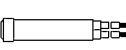
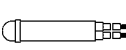
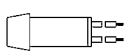
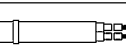
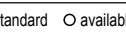
	Series Number	Fixing Hole Diameter (mm)	Bezel type	Lamp Type	Red	Green	Yellow	Amber	Blue	White	Clear	Red/Green/Yellow	Infrared	Round lens	Flat Lens	Conical lens	Metal Bezel	Plastic Bezel	Without resistor	Low voltage (6V, 12V, 24V, 28V)	High voltage AC (105 - 130V, 200 - 250V)	Special voltages	
	5111	4	Flat bezel	LED	●	●	●	●	○	○	—	○	—	●	—	—	—	●	●	—	—	—	
	5110				●	●	●	○	○	—	○	—	●	—	—	—	—	—	—	—	—	—	—
	5200	4.8	Flat bezel	LED	●	●	●	○	○	○	—	○	—	●	—	—	—	●	●	—	—	—	
	5210				●	●	●	○	○	—	○	—	●	—	—	—	—	—	—	—	—	—	—
	6039-0004-304	4.9	Flat bezel	LED	●	●	●	○	○	○	—	○	—	●	—	—	—	●	●	—	—	—	
	3990	5.5	Flat bezel	LED	●	●	●	●	○	○	—	○	—	●	—	—	—	●	●	—	—	—	
	1900	6	Superflat bezel	LED	●	●	●	—	—	—	—	—	—	—	●	—	●	—	—	●	—	○	
	1900			LED	●	●	●	—	—	—	—	—	—	—	—	●	—	●	—	—	●	—	—
	1902		Prominent bezel	LED	●	●	●	—	●	●	—	—	—	—	●	—	—	●	—	—	●	—	○
	1902			LED	●	●	●	—	●	●	—	—	—	—	—	●	—	—	●	—	—	—	—
	1903		Recessed bezel	LED	●	●	●	—	●	●	—	—	—	—	●	—	—	●	—	—	●	—	○
	1903			LED	●	●	●	—	●	●	—	—	—	—	—	●	—	—	●	—	—	—	—
	5101		6.4	Flat bezel	LED	●	●	●	●	●	○	—	●	—	●	—	—	—	●	●	●	—	—
	5100					●	●	●	●	○	—	●	—	—	—	—	—	—	—	—	—	—	—
	5120		7.5	Flat bezel	LED	●	●	●	—	—	—	—	—	—	●	—	—	—	●	●	—	—	—
	2110		7.9	Flat bezel	NEON INCANDESCENT LED	●	●	—	●	●	●	—	—	—	—	●	—	—	●	—	—	●	—
	2195	NEON INCANDESCENT LED			●	●	—	●	●	●	—	—	—	—	—	—	—	—	—	—	—	—	—
	2191	NEON INCANDESCENT LED			●	●	—	●	●	●	—	—	—	—	—	—	—	—	—	—	—	—	—
	4304	INCANDESCENT			●	●	—	●	●	●	—	—	—	—	—	—	—	—	—	—	—	—	—
	2191	NEON INCANDESCENT LED			●	●	●	●	●	—	—	—	—	—	—	●	—	—	—	—	—	—	—
	2194	NEON INCANDESCENT LED	●	●	●	●	●	—	—	—	—	—	—	—	—	—	—	—	—	—	—		

● standard ○ available on request — please contact our sales representative

Panel Mount Indicators

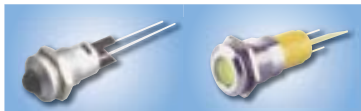

CML IT offers panel mount indicators manufactured with LED, Neon or Incandescent light sources. These indicators are available in a number of different lens and termination styles, with voltages of 2V ~ 250V available off-the-shelf.

The listing below contains generic product information.

Please visit our Website at www.cml-it.com for a more detailed listing of product specifications.

- standard
- available on request
- please contact our sales representative



	Series Number	Fixing Hole Diameter (mm)	Bezel type	Lamp Type	Red	Green	Yellow	Amber	Blue	White	Clear	Red/Green/Yellow	Infrared	Round lens	Flat Lens	Conical lens	Metal Bezel	Plastic Bezel	Without resistor	Low voltage (6V, 12V, 24V, 28V)	High voltage AC (105 - 130V, 208 - 250V)	Special voltages		
	1901 1910**	8	Superflat bezel	LED	●	●	●	■	■	■	■	●**	■	■	●	■	■	■	■	●	■	○		
	1901 1910**			LED	●	●	●	■	■	■	■	■	●**	■	■	●	■	■	■	■	■	■	■	■
	1904 1908 (Sunlight) 1951* 1901 (Flashing) 19TR**		Prominent bezel	LED	●	●	●	■	●	●	■	■	●**	■	●	■	■	●	■	■	■	●	■	○
	1904 1906 (Flashing) 1912**			LED	●	●	●	■	●	●	■	■	●**	■	●	■	■	●	■	■	■	■	■	■
	1905 1909 (Sunlight) 1950* 1907 (Flashing) 19TR**		Recessed bezel	LED	●	●	●	■	●	●	■	■	●**	■	●	■	■	●	■	■	■	■	●	○
	1905 1907 (Flashing) 1913**			LED	●	●	●	■	●	●	■	■	●**	■	●	■	■	●	■	■	■	■	■	■
	1920		With optic	LED	○	○	○	■	○	○	■	■	■	●	■	■	■	●	■	■	■	●	■	○
	1920			LED	○	○	○	■	○	○	■	■	■	●	■	■	■	●	■	■	■	■	■	■
	5400		Flat bezel	LED	●	●	●	●	■	■	■	■	■	■	■	■	■	■	■	■	■	■	■	■
	6010 6091		9.65	Flat bezel	LED NEON	●	●	●	●	■	■	■	■	■	●	■	■	●	■	■	■	●	●	■
	192D	12	Prominent bezel	LED	●	●	●	■	●	●	■	■	■	●	■	■	●	■	■	■	■	●	○	
	192D			LED	●	●	●	■	■	■	■	■	■	■	●	■	■	●	■	■	■	■	■	■
	1030 1050	12.75	Flat bezel	NEON INCANDESCENT LED	●	●	●	●	●	●	●	■	■	●	●	■	■	■	■	■	●	●	■	
	1921 192A (Sunlight) 1935* 1922 (Flashing) 1924**	14	Prominent bezel	LED	●	●	●	■	●	●	■	●**	■	●	■	■	●	■	■	■	■	●	○	
	1921 1922 (Flashing) 1924**			LED	●	●	●	■	■	■	■	■	●**	■	●	■	■	●	■	■	■	■	■	■
	1937 / 1940* (round lens) 1938 / 1941* (flat lens) 1939 / 1942* (conical lens)	16	Prominent bezel	LED	●	●	●	■	●	■	■	■	■	●	●	●	●	●	○	●	●	○		
	1970 / 1973* (round lens) 1971 / 1974* (flat lens) 1972 / 1975* (conical lens)	19	Prominent bezel	LED	●	●	●	■	●	■	■	■	■	●	●	●	●	■	○	●	●	○		
	195A / 195E* (round lens) 195B / 195F* (flat lens)	22	Prominent bezel	LED	●	●	●	■	●	●	■	■	■	●	●	■	●	●	○	●	●	○		
	2620 2660	22,25	Flat bezel	NEON	●	●	■	●	■	■	■	■	■	■	■	■	■	■	■	■	■	■	■	

T5 / T10 WB Based LEDs



The listing below contains generic product information.

Please visit our Website at www.cml-it.com for a more detailed listing of product specifications.

	Series Numbers	Size	Base Type	Number of LEDs	Red	Green	Yellow	Blue	White	Flashing	Low voltage DC (24V, 28V)	Low voltage AC/DC (24V, 28V)	High voltage DC (130V)	High voltage AC (130V, 230V)	High voltage AC/DC (130V, 230V)	Special voltages
	1511E	T-1 1/2 (5mm)	WB W2x4.6d	1	●	●	●	●	●	—	●	—	—	—	—	○
	1511F	T-3 1/4 (10mm)	WB W2.1x9.5d	1	●	●	●	●	●	—	●	—	—	—	—	○

● standard ○ available on request — please contact our sales representative



The listing below contains generic product information.

Please visit our Website at www.cml-it.com for a more detailed listing of product specifications.

Mechanical dimensions (mm)

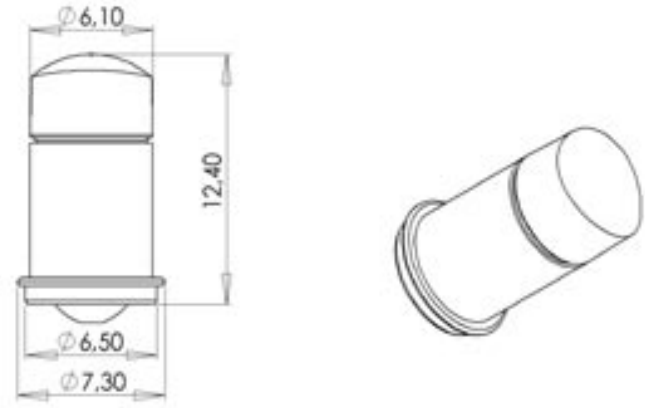

Technical operating data

	Part N°	Color	Lens	Power (W)	Voltage (V)	Typical Light Output (lm)
		white	special	0.3	28	4

Minimum and maximum ratings

Part N°	Minimax Voltage (V)	Operating Temperature (°C)	Storage Temperature (°C)	max Current Consumption (mA)
	26/30	-40 to 60	-40 to 85	13

Lamps



CML IT incandescent lamps include a diverse range of configurations and performance characteristics. Configurations include the basic wire terminal and a wide variety of base styles from micro midget flange to intermediate screw. These lamps are an ideal light source for all applications, back-lighting, illumination, and indication. They are available in a wide range of voltages from as low as 1.5V up to as high as 240V. The listing below contains generic product information.

Please visit our Website at www.cml-it.com for a more detailed listing of product specifications.

Bulb Shape	Size		Approximate diameter		Voltage range (V)	Light Output Range (Lm)	Light Output Range (MSCP)	Wire Terminal	Flange Base	Groove Base	Screw Base	Bayonet Base	Bi-Pin Base	Wedge Base	Slide Base	BA7s	Other Type	
	Inch	mm	Inch	mm														
	B-3 1/2	—	0.445	11.3	1.9 - 12.5	1.9 - 65.7	0.15 - 5.23	—	—	—	—	—	—	—	—	—	●	
	B-6	—	0.78	19.81	6 - 28	42.7 - 201	3.4 - 16	—	—	—	—	●	—	—	—	—	—	
	C7	—	0.875	22.23	115 - 125	16.3 - 56.5	1.3 - 4.5	—	—	—	●	●	—	—	—	—	—	
	G-2	—	0.25	6.35	7 - 28	0.83 - 4	0.066 - 0.32	—	—	—	●	—	—	—	—	—	—	
	G-3 1/2	G11	0.433	11	1.25 - 28	0.5 - 25.1	0.02 - 3.5	—	—	—	●	●	—	—	—	—	●	
	G-4 1/2	—	0.59	15	1.25 - 28	1.2 - 45.2	0.1 - 3.6	—	—	—	●	●	—	—	—	—	●	
	G-6	—	0.75	19	6.5 - 32	20.1 - 75.4	1.6 - 6	—	—	—	●	●	—	—	—	—	—	
	GTL-1 1/2	—	0.235	6	2.5	—	—	—	—	●	—	—	—	—	—	—	—	
	GTL-1 3/4	—	0.235	6	2.5	—	—	●	●	—	—	—	—	—	—	—	—	
	GTL-3	—	0.375	9.53	1.2 - 3.8	—	—	—	—	—	●	—	—	—	—	—	—	
	R-12	—	1.546	39.26	6 - 28	—	—	—	—	—	—	●	—	—	—	—	—	
	RP-11	—	1.42	36.1	5.5 - 44	263.9 - 1319.4	21 - 105	—	—	—	—	●	—	—	—	—	—	
	S-6	—	0.75	19	6 - 250	—	0.95 - 4.8	—	—	—	●	●	—	—	—	—	—	
	S-8	—	1.04	26.44	4 - 45	25.1 - 628.3	2 - 50	—	—	—	—	●	—	—	—	—	●	
	S-11	—	1.42	36	6.2 - 28	402.1 - 628.3	32 - 50	—	—	—	—	●	—	—	—	—	—	
	T-3/4	—	0.094	2.39	1.5 - 5	0.013 - 2.5	0.001 - 0.2	●	●	—	—	—	●	—	—	—	—	
	T-1	T3	0.125	3.18	1.25 - 28	0.012 - 3.1	0.001 - 0.25	●	●	—	—	—	●	—	—	—	—	
	T-1 1/4	T4	0.168	4.26	1.3 - 28	0.025 - 7.9	0.002 - 0.63	●	●	—	●	—	●	●	—	—	—	
	T-1 1/2	T5	0.197	5	5 - 28	0.3 - 18.6	0.024 - 1.5	●	—	—	—	—	●	●	—	—	—	
	T-1 3/4	T5.6	0.22	5.85	1.30 - 60	0.012	0.001 - 1.5	●	●	●	●	—	●	●	—	—	—	
	T-2	—	0.275 - 0.325	6.99 - 8.26	4.00 - 120	—	60 - 4000 EFC (*)	●	—	—	—	●	—	—	—	●	—	
		T6.5	0.248 - 0.263	6.3 - 6.7	6 - 24	8 - 23	0.64 - 1.8	—	—	—	—	—	—	●	—	—	—	
		T-2 1/8	T6.8	0.268	6.8	6 - 24	2.5 - 8.8	0.2 - 0.7	—	—	—	—	—	—	—	—	●	—
		T7	0.272 - 0.279	6.9 - 7.1	12 - 24	8 - 23.5	0.64 - 1.87	—	—	—	—	—	—	●	—	—	—	
		T-2 7/8	T9	0.355	9	6 - 60	2.5 - 6.3	0.2 - 0.5	—	—	—	—	●	—	—	—	—	—
		T-3 1/4	T10	0.4	10.3	1.35 - 130	1 - 84	0.08 - 6.68	—	—	—	●	●	—	●	—	—	—
		T-4 1/2	—	0.588	14.94	6.3 - 130	18.9 - 113.1	1.5 - 9	—	—	—	●	●	—	—	—	—	—
		T-5	T15	0.6	16	3.5 - 120	44 - 310	3.2 - 25	—	—	—	●	●	—	●	—	—	—
		T-6	—	0.75	19.05	60 - 150	105.5 - 119.4	8.4 - 9.5	—	—	—	●	●	—	—	—	—	—
		T-6 1/3	T20	0.787	20	12	440 - 460	35 - 36.6	—	—	—	—	—	—	●	—	—	—
		T-6 1/2	—	0.813	20.65	115 - 125	90.5 - 251.3	7.2 - 20	—	—	—	●	●	—	—	—	—	—
		T-7	—	0.875	22.23	115 - 125	100.5 - 125.6	8 - 10	—	—	—	●	●	—	—	—	—	—
	T-8	—	1.06	26.92	115 - 230	149.5 - 235	11.9 - 18.7	—	—	—	●	●	—	—	—	—	—	
	TL-3/4	—	0.094	2.39	5	—	—	●	●	—	—	—	●	—	—	—	—	
	TL-1	—	0.125	3.18	1.5 - 5	—	—	●	●	—	—	—	●	—	—	—	—	
	TL-1 3/4	—	0.23	5.85	2.5 - 14	—	—	●	●	●	●	—	●	—	—	—	—	

● standard ○ available on request — please contact our sales representative

Neon Lamps



CML IT line of Neon lamps include, standard wire terminal lamps as well as many based options. Lamps are designed for use at line voltages of 100~125 VAC or 200~250 VAC, and come with or without resistors attached to the lamp. The leads on the lamps can also be cut and formed to custom sizes upon request. The listing below contains generic product information.

Please visit our Website at www.cml-it.com for a more detailed listing of product specifications.

Bulb Shape	SIZE	BASE TYPES					COLOR		VOLTAGE			HOUSING	
		Wire Terminal	Midget Flange Base	Slide Base	Bayonet Base	Screw Base	Red	Green	115VAC	230VAC	400VAC	White plastic	Clear plastic
	G-10	-	-	-	●	-	●	-	●	●	○	-	-
	S-11	-	-	-	-	●	●	-	●	●	○	-	-
	S-7	-	-	-	●	-	●	-	●	●	○	-	-
	S-14	-	-	-	●	●	●	-	●	●	○	-	-
	T-1 1/4	●	-	-	-	-	●	●	●	●	○	-	-
	T-1 3/4	●	●	-	-	-	●	●	●	●	○	-	-
	T-2	-	-	●	-	-	●	-	●	●	○	-	-
	T-3 1/4	-	-	-	●	●	●	●	●	●	○	●	●
	T4 1/2	-	-	-	-	●	●	●	●	●	○	●	●

● standard ○ available on request - please contact our sales representative

Socketed Lamps



CML IT is the premier manufacturer of socketed lamps. Our design expertise is number one with most automotive manufacturers specifying CML IT as OEM. These products comprise a filament lamp or LED inserted into a plastic socket. Some variants have the lamp permanently installed within the socket using welded assembly techniques for ultimate contact reliability, other types utilize wire wrap for SMD and twist and turn installation. The listing below contains generic product information.

Please visit our Website at www.cml-it.com for a more detailed listing of product specifications.

Bulb Shape	Bulb Type		Approximate diameter		Voltage range (V)	Light Output Range (Lm)	Light Output Range (MSCP)	Coloured silicon caps available	PCB Twist Lock Single Contact	PCB Twist Lock Double Contact	Twist Lock With connector	Twist Lock With connector - Right Angle	Twist Lock With Wire Terminals	Twist Lock Neo-Wedge	Bi-Pin	SMD	Snap In	Other										
	Inch	mm	inch	mm																								
		P21	1.04	26.5	6-24	390-530	31-42.1	-	-	-	-	●	-	-	-	-	-	-	-									
	T-1	T3	0.125	3	5-14	0.9-3.1	0.08-0.25	●	-	-	-	-	-	●	●	●	-	-	-									
	T-1 1/4	T4	0.166	4	14	3.8-6.3	0.3-0.5	●	-	-	-	-	-	●	●	●	●	-	-									
	T-1 1/2	T5	0.197	5	6-28	0.8-23.5	0.06-1.87	●	●	●	-	-	●	●	●	●	-	-	-									
	T-1 3/4	T5.6	0.22	5.6	24-28	4-13.8	0.32-1.1	●	●	●	-	-	-	-	-	-	-	-	-									
	T-2	T6	0.255	6	12-14	5.5-37.7	0.44-3	●	-	●	-	-	-	●	-	-	-	-	-									
	T-2 1/4	T7	0.29	7	8-12	16.3	1.3	-	-	●	-	-	-	-	-	-	-	-	-									
	T-3 1/4	T10	0.393	10	6.3-28	11-84	0.65-6.7	-	-	●	●	-	●	-	-	-	-	-	-									
	T-5	T15	0.6	16	6-120	75.4-310	3.2-25	-	-	●	-	-	-	-	-	-	-	-	-									

● standard ○ available on request — please contact our sales representative



Sockets



CML IT a world leader for the manufacture and supply of lamp sockets particularly for the automotive industry. Our sockets are designed and manufactured 'in-house' using precision injection molding and metal stamping techniques. We specialize in twist and turn sockets using push-in wedge base lamps which are automatically assembled and tested using sophisticated test and inspection equipment.

The listing below contains generic product information.

Please visit our Website at www.cml-it.com for a more detailed listing of product specifications.

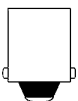
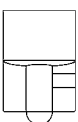
Bulb Base Type	Bulb Type		Approximate diameter		Voltage range (V)	PCB Twist Lock Single Contact	PCB Twist Lock Double Contact	Twist Lock With connector	Twist Lock With connector - Right Angle	Twist Lock Neo-Wedge	Relampable
	Inch	mm	inch	mm							
		P21	1.04	26.5	6 - 24	-	-	-	●	-	●
	T1 1/2	T 5	0.197	5	12 - 24	●	●	-	-	●	●
	T1 3/4	T 5.6	0.22	5.6	12 - 24	●	●	-	-	-	●
	T 3 1/4	T 10	0.393	10	12 - 24	-	●	●	-	●	●
	T5	T 15	0.59	15	12 - 24	●	-	-	-	-	●

● standard ○ available on request - please contact our sales representative



Aviation Lamps



Vertically integrated design, engineering, manufacturing, and assembly capabilities make CML responsive to the needs of aircraft manufacturers and maintenance facilities around the world.

Every aviation lamp we produce is designed to meet or exceed critical requirements for light output and service life. Each design anticipates environmental, electrical, and photometric conditions for aircraft or ground support applications. And CML inspection, testing, and statistical documentation set the standard for the industry.

The result is a lamp that will not only deliver top rated performance and optimum service life -- it will also cost less for you to own and operate.

Choose from a broad range of styles and operating characteristics for an equally diverse range of applications. Status indicators, Instrumentation lighting, Cabin and flight deck lighting, Navigation and anti-collision lighting, and Inspection lighting.

The listing below contains generic product information.

Please visit our Website at www.cml-it.com for a more detailed listing of product specifications.

Aviation Halogen Aircraft Lamp

Volts (V)	Wattage (W)	Light Output		Filament shape	Life Hours	Lamp Base	Part N°
		Lm	Mscp				
10	100	1630	130	C-8	1000	end caps	1978X
12	10	126	10	C-81	2000	bayonet BA9s	2059
28	50	750	60	CC-8	1000	end caps	8-A103
28	100	1760	140	CC-8	1000	end caps	1970X

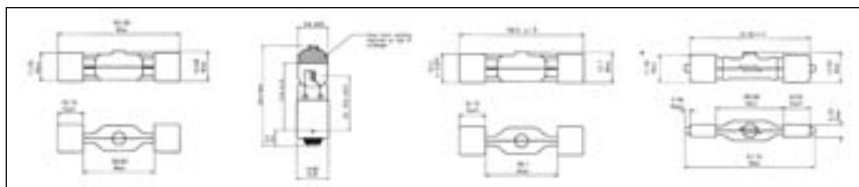

Aviation Anti-Collision Warning Lamp



Volts (V)	Wattage (W)	Filament shape	Life Hours	Lamp Base	Part N°
28	21	CC-6	300	Bayonet BA15s	CM1524
28	26	CC-6	300	Bayonet BA15s	A-7512-24
28	40	CC-6	300	Bayonet BA15s	A-4174-24

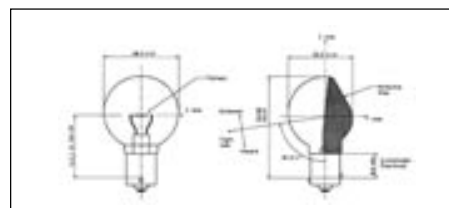
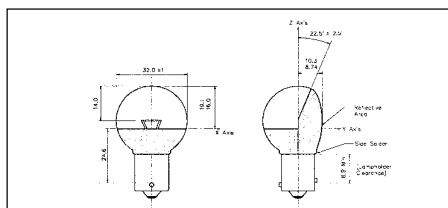

Aviation Xenon Flashtube

Max Length mm	Max Length Inches	Rated Life Hrs	Light Output Lm	Wattage (W)	Lamp Base	Part N°
117	4,6	2000*	95cd/s@32j	40	Special End Caps	55-0331-3

* Life defined as 9 million flashes at flash rate of 75 flashes per minute
 = $(9 \times 10^6) / 75 = 120,000 \text{ min} = 2000 \text{ hours}$.
 cd/s = candelas per second. Please note the size designation is T2^{1/2} (T8).

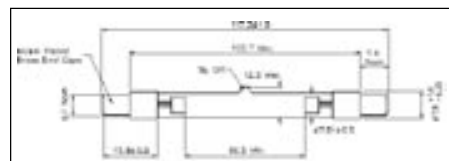

Aviation Lamps



Vertically integrated design, engineering, manufacturing, and assembly capabilities make CML responsive to the needs of aircraft manufacturers and maintenance facilities around the world.

Every aviation lamp we produce is designed to meet or exceed critical requirements for light output and service life. Each design anticipates environmental, electrical, and photometric conditions for aircraft or ground support applications. And CML inspection, testing, and statistical documentation set the standard for the industry.

The result is a lamp that will not only deliver top rated performance and optimum service life -- it will also cost less for you to own and operate.

Choose from a broad range of styles and operating characteristics for an equally diverse range of applications. Status indicators, Instrumentation lighting, Cabin and flight deck lighting, Navigation and anti-collision lighting, and Inspection lighting.

The listing below contains generic product information.

Please visit our Website at www.cml-it.com for a more detailed listing of product specifications.

Aviation Incandescent Aircraft Lamp

Volts (V)	Wattage	Light Output		Filament shape	Life Hours	Size	Lamp Base	Fig.	Part N°
		Lm	Mscp						
5	60mA	0.63	0.05	C-2R	40.000	T1 (T3)	Wire terminal	1	683
5	115mA	1.9	0.15	C-2R	40.000	T1 (T3)	B-Pin (2,54)	2	8-2400
28	24mA	1.9	0.15	CC-2F	4.000	T1 (T3)	B-Pin (2,54)	2	8-2402
28	50mA	3.8	0.3	C-2F	16.000	T11/4 (T4)	Special Midget Flange	3	737AS15
28	40mA	3.8	0.3	C-2F	7.000	T11/4 (T5.6)	Midget Flange, SX6s	4	387
28	40mA	4.3	0.34	C-2F	4.000	T13/4 (T5.6)	Midget Groove, S5.7s	5	334
28	40mA	3.8	0.3	C-2F	7.000	T13/4 (T5.6)	Bi-Pin (3.18)	6	7387
28	300mA	75	6	C-2F	500	T41/2 (T14)	Miniature Bayonet, BA9s	7	1495
28	560mA	201	16	CC-8	2.000	B-6 (B19)	Bayonet BA15s	8	1308
28	520mA	188	15	2xC-2R	300	B-6 (B19)	Bayonet BA15s	8	1309IF
28	510mA	188	15	C-2V	300	S-8 (S25)	Bayonet BA15s	9	305
28	670mA	264	21	C-2V	300	S-8 (S25)	Bayonet BA15s	9	307
28	17W	188	15	2xC-2R	1.000	S-8 (S25)	Bayonet BA15s	9	1691
28	18W	226	18	CC-8S	2.000	S-8 (S25)	Bayonet BA15s	9	2332SB
28	21W	264	21	CC-8S	2.000	S-8 (S25)	Bayonet BA15s	9	2233
28	36W	553	44	C-2V	1.000	S-11 (S35)	Bayonet BA15s	10	3011
28	800mA	264	21	C-2V	1.000	S-8 (S25)	Bayonet BA15s	9	1665
28	1020mA	402	32	2C-6	500	S-8 (S25)	Bayonet BA15s	9	1683
28	610mA	188	15	2C-2R	1000	S-8 (S25)	Bayonet BA15s	9	1691
6	2000mA	238	19	C6	50	T21/4 (T7)	Miniature Bayonet, BA9s	11	767
28	24mA	1.6	0.13	CC-2F	4000	T1 (T3)	Sub-midget flange	12	6839

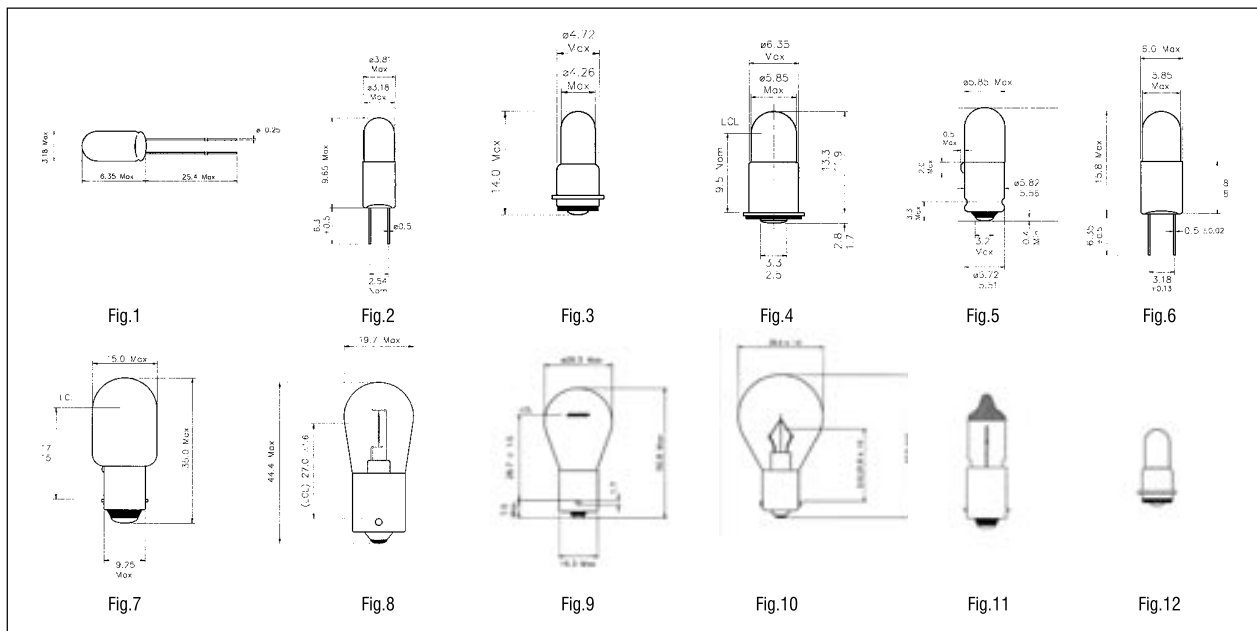

Aviation Fluorescent Lamps



Vertically integrated design, engineering, manufacturing, and assembly capabilities make CML responsive to the needs of aircraft manufacturers and maintenance facilities around the world.

Every aviation lamp we produce is designed to meet or exceed critical requirements for light output and service life. Each design anticipates environmental, electrical, and photometric conditions for aircraft or ground support applications. And CML inspection, testing, and statistical documentation set the standard for the industry.

The result is a lamp that will not only deliver top rated performance and optimum service life -- it will also cost less for you to own and operate.

Choose from a broad range of styles and operating characteristics for an equally diverse range of applications. Status indicators, Instrumentation lighting, Cabin and flight deck lighting, Navigation and anti-collision lighting, and Inspection lighting.

The listing below contains generic product information.

Please visit our Website at www.cml-it.com for a more detailed listing of product specifications.

Aviation Fluorescent Lamp

Max Length Rated		Life Hrs	Light Output Lm	Wattage W	Colour	Cap	Fig. N°	Part N°
mm	inches							
T5 (Ø 16mm)								
150	6	7500	145	4	Warm White	G5, Bi-Pin	1	CM5104WW
150	6	7500	140	4	Cool White	G5, Bi-Pin	1	CM5104CW
150	6	7500	145	4	Warm White	Pinless	2	5004WW
150	6	7500	140	4	Cool White	Pinless	2	5004CW
226	9	7500	290	6	Warm White	G5, Bi-Pin	1	CM5106WW
226	9	7500	270	6	Cool White	G5, Bi-Pin	1	CM5106CW
302	12	7500	400	8	Warm White	G5, Bi-Pin	1	CM5108WW
302	12	7500	380	8	Cool White	G5, Bi-Pin	1	CM5108CW
302	12	7500	400	8	Warm White	Pinless	2	5008WW
302	12	7500	380	8	Cool White	Pinless	2	5008CW
531	21	7500	880	13	Warm White	G5, Bi-Pin	1	CM5113WW
531	21	7500	860	13	Cool White	G5, Bi-Pin	1	CM5113CW
531	21	7500	880	13	Warm White	Pinless	2	5013WW
531	21	7500	860	13	Cool White	Pinless	2	5013CW
760	30	8000	1150	18	Warm White	G5, Bi-Pin	1	18WT5-WW
760	30	8000	1150	18	Cool White	G5, Bi-Pin	1	18WT5-CW
T8 (Ø 25mm)								
909	36	14000	2200	30	Cool White	G13, Bi-Pin	1	F30W133TB
T12 (Ø 35mm)								
984	39	9000	2800	40	Warm White	G13, Bi-Pin	1	F40W1M129
984	39	9000	2800	40	Cool White	G13, Bi-Pin	1	F40W1M133

Fig.1

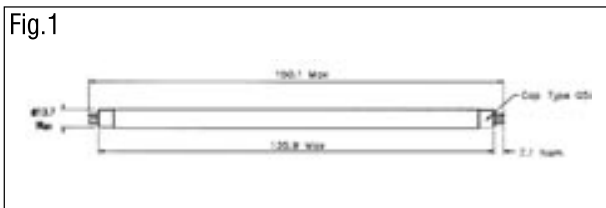
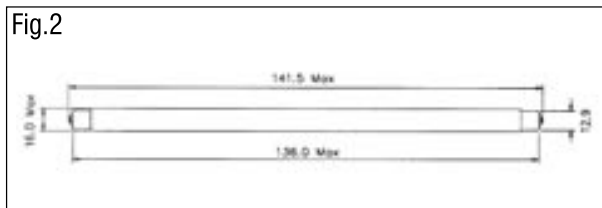

Fig.2



CCFL & Inverters



CML IT range of cold cathode fluorescent lamps is proving increasingly popular where strong white light sources are required to give even light distribution over large surface areas.

Small diameter tubes are highly efficient in providing reliable illumination with life time up to 50,000 hours.

The listing below contains generic product information.

Please visit our Website at www.cml-it.com for a more detailed listing of product specifications.

Diameter (mm)	Series Number	Overall Length (mm)	Active Length (mm)	Surface Brightness (Cd/mm ²)	Voltage (V)	Watts (W)	Bar Shape	U Shape
1.8	CCFL18	220 - 280	205 - 265	50,000	540 - 660	2.7 - 3.3	●	—
2.0	CCFL 20	40 - 150	27.5 - 135	43,000	160 - 400	0.8 - 2	●	—
2.6	CCFL 26	100 - 420	85 - 400	30,000	265 - 850	1.3 - 4.25	●	●
4.1	CCFL 41	100 - 400	75 - 375	14,000	260 - 800	1.3 - 4	●	—

● standard ○ available on request — please contact our sales representative

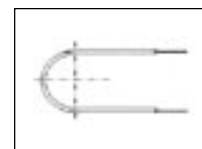
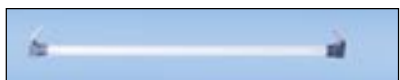

These are best described as electronic ballasts providing the power source for our range of CCFL products. All CML-IT models offer low voltage DC input with long life.

The listing below contains generic product information.

Please visit our Website at www.cml-it.com for a more detailed listing of product specifications.

Inverter types	Series Number	Application	Dimensions (mm) W x L x H	CCFL Length (mm)	Input voltage	Input current (mA)	Output voltage (V)	Output Current Max. (mA)	Number of drive circuits	Operating Temp Range (°C)
	INV 1	CCFL	18 x 49 x 13	50 - 150 mm	12VDC	210 - 900	260 to 850	5	1	0 - 50
	INV 5	CCFL	18 x 49 x 13	50 - 150 mm	12VDC	210 - 900	260 to 850	5	2	0 - 50
	INV 2	CCFL	20 x 70 x 15	150 - 300 mm	12VDC	210 - 900	260 to 850	5	1	0 - 50
	INV 6	CCFL	20 x 70 x 15	150 - 300 mm	12VDC	210 - 900	260 to 850	5	2	0 - 50
	INV 4	CCFL	25 x 75 x 15	300 - 420 mm	12VDC	210 - 900	260 to 850	5	1	0 - 50
	INV 8	CCFL	25 x 75 x 15	300 - 420 mm	12VDC	210 - 900	260 to 850	5	2	0 - 50
	INV 9	CCFL	18 x 49 x 13	50 - 150 mm	5VDC	210 - 900	260 to 850	5	1	0 - 50
	INV 11	CCFL	18 x 49 x 13	50 - 150 mm	5VDC	210 - 900	260 to 850	5	2	0 - 50
INV 10	CCFL	20 x 70 x 15	150 - 280 mm	5VDC	210 - 900	260 to 850	5	1	0 - 50	

Power Supply types	Series Numbers	Application	Dimensions (mm) W x L x H	Application (Watt)	Input voltage	Input current (mA)	Output voltage (VDC)	Output Current Max. (A)	Number of drive circuits	Operating Temp Range (°C)
	CMPS Series	LED BrightStrips	3.7"x1"x1.5" 94mm x 25.4 mm x 38.1mm	upto 20 Watt	100VAC - 240VAC	300mA	8 to 13.5	1.67 A	4 to 20 ft 1.2 to 6 m	0 - 50
		LED BrightStrips	9.5"x1.5"x2.4" 241mm x 38.1 mm x 61 mm	upto 60 Watt	100VAC - 240VAC	1000mA	12	5.0 A	12 to 60 ft 3.6 to 18.2 m	-20 +70
		LED BrightStrips	4"x1.25"x2" 102 mm x 32 mm x 51 mm	upto 30 Watt	100VAC - 240VAC	1000mA	12	2.5 A	6 to 30 ft 1.8 to 9.1 m	-20 +70

Xenon Lamps, Sockets, & Sixcess Lamps



The listing below contains generic product information.

Please visit our Website at www.cml-it.com for a more detailed listing of product specifications.

Xenon Lamps

Bulb Shape	Size		Approximate diameter		Series number	Voltage range (V)	Light Output Range (Lm)	Light Output Range (MSCP)	Wire Terminal	Flange Base	Groove Base	Screw Base	Bayonet Base	Bi-Pin Base	Wedge Base	Slide Base	BA7s	Other Type
	Inch	mm	inch	mm														
	T3 1/4	T10	0.4	10.3	1260XLF	12	85	6.75	—	—	—	—	—	—	●	—	—	—
	T3 1/4	T10	0.4	10.3	1503XLF	14	25	2	—	—	—	—	—	—	●	—	—	—
	T3 1/4	T10	0.4	10.3	501XLF	12	50	4	—	—	—	—	—	—	●	—	—	—

● standard ○ available on request — please contact our sales representative

Sockets for Xenon Lamps

Bulb Base Type	Series Numbers	Bulb Type		Approximate diameter		Circuit Thickness (mm)	Voltage range (V)	PCB Twist Lock - Single Contact	PCB Twist Lock - Double contact	Twist Lock - With Connector	Twist Lock - With Connector - Right Angle	Twist Lock Neo-Wedge	Relampable
		Inch	mm	inch	mm								
	7121x	T3 1/4	T10	0.393	10	1.6 +/- 0.1	12-24	—	●	—	—	—	●
	7080x	T3 1/4	T10	0.393	10	2.0 +/- 0.1	12-24	—	●	—	—	—	●

● standard ○ available on request — please contact our sales representative

Sixcess Lamps

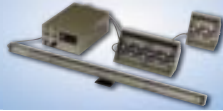

Series Numbers	Size	E12	E14	White	Color Temperature	12V AC/DC	24V AC/DC
2410F73-24V		●	—	●	3100°K	—	●

● standard ○ available on request — please contact our sales representative



The listing below contains generic product information.

Please visit our Website at www.cml-it.com for a more detailed listing of product specifications.

	Series Numbers	Size	Voltage input	Voltage output	Power consumption	with Optic	Color RGB	Color AMB	
	DMX COLORDIRECTOR 12V ONE	CR-CD0 Series 320 x 230 x 120 mm	100 - 240 VAC	12 VDC	60 W				
	DMX COLORDIRECTOR 12V Four		100 - 240 VAC	12 VDC	500 W				
	DMX COLORDIRECTOR 24V ONE		100 - 240 VAC	24 VDC	60 W				
	DMX COLORDIRECTOR 24V Four		100 - 240 VAC	24 VDC	500 W				
	Flood	CR-FL0 Series	149 x 174 x 66 mm	12 VDC		9 W		● ●	
			149 x 174 x 66 mm	12 VDC		9 W	● ● ●		
			149 x 174 x 66 mm	24 VDC		18 W		● ●	
			149 x 174 x 66 mm	24 VDC		18 W	● ● ●		
			300 x 174 x 66 mm	24 VDC		18 W		● ●	
			300 x 174 x 66 mm	24 VDC		18 W	● ● ●		
			300 x 174 x 66 mm	24 VDC		36 W		● ●	
			300 x 174 x 66 mm	24 VDC		36 W	● ● ●		
	Linear	CR-LI0 Series	500 x 50 x 40 mm	24 VDC		18 W		● ●	
			500 x 50 x 40 mm	24 VDC		18 W	● ● ●		
			1000 x 50 x 40 mm	24 VDC		36 W		● ●	
			1000 x 50 x 40 mm	24 VDC		36 W	● ● ●		
	Wall Unit Up/Down	CR-WU Series	2280 x 1400 mm	12 VDC		20 W	— ● —		
	Submersible	CR-SU0 Series	Ø 150 x 90 mm	12 VDC		10 W	— ● —		







● standard ○ available on request — please contact our sales representative

Traffic Lights

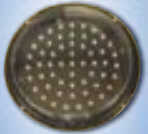

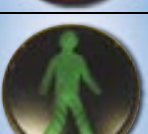
The listing below contains generic product information.

Please visit our Website at www.cml-it.com for a more detailed listing of product specifications.

		Series Numbers	Size	Red	Amber	Green	White	Voltage 40V	Voltage 90 - 140 VAC	Voltage 180 - 285 VAC	Initial Intensity
	High Brite	TL210xx-xHB Series	210 mm	●	●	●	—	○	●	●	200 - 800 cd
	High Flux Clear			●	●	●	—	○	●	●	200 - 800 cd
	High Flux Tinted	TL210xx-xHF Series		●	●	●	—	○	●	●	200 - 800 cd
	High Flux Stop Man Straight Arrow Left Arrow Right Arrow Pedetrain Walk Man			●	●	●	—	○	●	●	200 - 800 cd
	High Brite	TL300xx-xHB Series	300 mm	●	●	●	—	○	●	●	200 - 800 cd
	High Flux Clear			●	●	●	—	○	●	●	200 - 800 cd
	High Flux Tinted	TL300xx-xHF Series		●	●	●	—	○	●	●	200 - 800 cd
	High Flux Stop Man Straight Arrow Left Arrow Right Arrow Pedetrain Walk Man			●	●	●	—	○	●	●	200 - 800 cd

● standard ○ available on request — please contact our sales representative



The listing below contains generic product information.

Please visit our Website at www.cml-it.com for a more detailed listing of product specifications.

		Series Numbers	Length 18» / 457mm	Length 36» / 914mm	Length 48» / 1219mm	Length 72» / 1829mm	Length 96» / 2438mm	Diameter 0.23 / 5.8mm (non-oblent, flexible)	Diameter 0.4» / 10.5mm (obedient)	Dual Shaft / Convertible 2 in 1
	Scope	PV-618	●	-	-	-	-	●	-	-
	Scope	PV-100	●	-	-	-	-	-	●	-
	Scope	PV2618-21	●	-	-	-	-	-	-	●
	Scope	PV-636	-	●	-	-	-	●	-	-
	Scope	PV-300	-	●	-	-	-	-	●	-
	Scope	PV2636-21	-	●	-	-	-	-	-	●
	Scope	PV-480	-	-	●	-	-	-	●	-
	Scope	PV-720	-	-	-	●	-	-	●	-
	Scope	PV-960	-	-	-	-	●	-	●	-

Accessories

		Series Numbers	PV-618	PV-100	PV2618-21	PV-636	PV-300	PV2636-21	PV-480	PV-720	PV-960
	ProView 45 Clip On Mirror 45°	PVW-45M	●	-	-	●	-	-	-	-	-
		PVW-45	-	●	-	-	●	-	●	●	●
	ProMag 1 Clip In - Magnetic Tip	PM-1M	●	-	-	●	-	-	-	-	-
		PM-1	-	●	-	-	●	-	●	●	●
	ProLite - Halogen Bulb	PL1000	●	●	●	●	●	●	●	●	●
	ProView 45 Kit	PVK-45M	●	-	-	●	-	-	-	-	-
		PVK-45	-	●	-	-	●	-	●	●	●
	ProView 45 Kit	PVKM-45M	●	-	-	●	-	-	-	-	-
		PVKM-45	-	●	-	-	●	-	●	●	●
	Rubber Eye Cup	PVEG1	●	●	-	●	●	-	●	●	●
		PVCC37	●	●	-	●	●	-	●	●	●
	Protective Boots	PVB	●	●	-	●	●	-	●	●	●

● standard ○ available on request - please contact our sales representative

8-2400.....	27	1939.....	19	5636.....	7
8-2402.....	27	1940.....	19	5638.....	7
8-A103.....	26	1941.....	19	5640.....	6
18WVT5-CW.....	28	1942.....	19	5670.....	6
18WVT5-WW.....	28	1970.....	19	5680.....	6
19TR.....	19	1970X.....	26	5681.....	6
43xxD.....	5	1971.....	19	5684.....	6
43xxF.....	5	1972.....	19	5693.....	6
43xxH.....	5	1973.....	19	5694.....	6
43xxR.....	5	1974.....	19	5894.....	7
55-0331-3.....	26	1975.....	19	5994.....	7
192A.....	19	1978X.....	26	6010.....	19
192D.....	19	2059.....	26	6039-0004-304.....	18
195.....	18	2110.....	18	6091.....	19
195A.....	19	2191.....	18	6200.....	5
195B/195F.....	19	2194.....	18	6255.....	5
195E.....	19	2232SB.....	27	6839.....	27
305.....	27	2233.....	27	7011X.....	5
307.....	27	2410F13-12V.....	30	7016X.....	5
334.....	27	2410F13-24V.....	30	7080X.....	30
387.....	27	2990.....	18	7121X.....	30
501XLF.....	30	3011.....	27	7387.....	27
553.....	6	3990.....	18	7511.....	8
683.....	27	4304.....	18	7512.....	8
737AS15.....	27	4361H.....	5	7520.....	8
754xxSSxSeries.....	15	4361L.....	5	7530ASeries.....	15
767.....	27	4361M.....	5	8510LE15Series.....	14
1030.....	19	4362D.....	5	8511LE16Series.....	14
1030.....	19	5004CW.....	28	8570LE12Series.....	14
1970/1973,1971/1974,1972/1975.....	19	5004WW.....	28	9500CL-xxx.....	9
1260XLF.....	30	5008CW.....	28	9520CL-xxx.....	9
1308.....	28	5008WW.....	28	15010.....	17
1309IF.....	27	5013CW.....	28	15012.....	17
1495.....	27	5013WW.....	28	15015.....	16
1503XLF.....	30	5100.....	18	15020.....	17
1511A.....	16	5101.....	18	15021.....	17
1511B.....	16	5110.....	18	15030.....	17
1511E.....	16	5111.....	18	15031.....	17
1511F.....	16	5120.....	18	15040.....	17
1665.....	27	5200.....	18	15041.....	16-17
1683.....	27	5210.....	18	15050.....	17
1691.....	27	5300.....	6	15051.....	16-17
1900.....	18	5306.....	6	15071.....	16-17
1901.....	19	5306.....	6	15080.....	17
1902.....	18	5311.....	6	15086.....	16
1903.....	18	5320.....	6	15087.....	16
1904.....	19	5321.....	6	15090.....	17
1905.....	19	5322.....	6	15091.....	17
1906.....	19	5324.....	6	15095.....	16
1907.....	19	5326.....	6	15100.....	17
1908.....	19	5341.....	6	15101.....	16-17
1909.....	19	5350.....	7	15110.....	17
1910.....	19	5360.....	6	15112.....	17
1912.....	19	5365.....	6	15113.....	17
1913.....	19	5370.....	7	15120.....	17
1920.....	19	5390.....	6	15121.....	16-17
1921.....	19	5400.....	19	15130.....	17
1922.....	19	5600.....	6	15139.....	17
1924.....	19	5610.....	6	15140.....	17
1935.....	19	5630.....	7	15161.....	16-17
1937.....	19	5632.....	7	18240.....	17
1938.....	19	5635.....	7	18270.....	17

18271.....	17	CMDA5.....	5	ILL2A0005x.....	10
18290.....	17	CMDA6.....	5	ILL3A0001x.....	10
18291.....	17	CMDA19.....	5	ILL3A0002x.....	10
18310.....	17	CMDA30.....	4	ILL3A0003x.....	10
18311.....	17	CMDA30RGB.....	4	ILL3A0004x.....	10
18330.....	17	CMDA31RGB.....	4	ILL5A0001x.....	11
18331.....	17	CMDA59RGB.....	4	ILL5A0002x.....	10
18580.....	16	CMDA31.....	4	INV1.....	29
18581.....	16	CMDA32.....	4	INV2.....	29
18600.....	16	CMDA33.....	4	INV4.....	29
18601.....	16	CMDA34.....	4	INV5.....	29
18606.....	16	CMDA35.....	4	INV6.....	29
18607.....	16	CMDA36.....	4	INV8.....	29
18608.....	16	CMDA37.....	4	INV9.....	29
18609.....	16	CMDA38.....	4	INV10.....	29
18630.....	16	CMDA39.....	4	INV11.....	29
18631.....	16	CMDA40.....	4	LAMPS.....	22
18633.....	16	CMDA41.....	4	LM-Axxx-1x1.....	9
18634.....	16	CMDA42.....	4	LM-Axxx-2x2.....	9
18636.....	16	CMDA43.....	4	LM-Axxx-2x4.....	9
18637.....	16	CMDA44.....	4	LM-Axxx-6x12.....	9
18640.....	16	CMDA48.....	4	LM-Bxxx-1.....	9
18641.....	16	CMDA49.....	4	LM-Bxxx-2.....	9
18643.....	16	CMDA50.....	4	LM-Cxxx.....	9
18644.....	16	CMDA51.....	4	LM-FB20F-12.....	9
18646.....	16	CMDA52.....	4	LM-FB26x.....	9
18647.....	16	CMDA53.....	4	LM-FB26x-12.....	9
18680.....	16	CMDA54.....	4	MFB.....	21
A-4174-24.....	26	CMDA55.....	4	NEON LAMPS.....	23
A-4712-24.....	26	CMDA56.....	4	PL1000.....	33
CCFL18.....	29	CMLxxxBC.....	13	PM-1.....	33
CCFL20.....	29	CMLxxxBS.....	13	PM-1M.....	33
CCFL26.....	29	CMLxxxGC.....	13	PV-100.....	33
CCFL41.....	29	CMLxxxGS.....	13	PV-300.....	33
CM-200LM012-xxx.....	9	CMLxxxRC.....	13	PV-480.....	33
CM-200LM018-xxx.....	9	CMLxxxRS.....	13	PV-618.....	33
CMI524.....	26	CMLxxxWC.....	13	PV-636.....	33
CM5104CW.....	28	CMLxxxWS.....	13	PV-720.....	33
CM5104WW.....	28	CMLxxxYC.....	13	PV-960.....	33
CM5106CW.....	28	CMLxxxYS.....	13	PV2618-21.....	33
CM5106WW.....	28	CMLGX53xx.....	13	PV2636-21.....	33
CM5108CW.....	28	CMPS1215S.....	12	PVB.....	33
CM5108WW.....	28	CMPS1260S.....	12	PVCC37.....	33
CM5113CW.....	28	CMPS2415S.....	12	PVEG1.....	33
CMD5-124.....	5	CMPS2460S.....	12	PVK-45.....	33
CMD12-21.....	5	CMPSSeries.....	29	PVK-45M.....	33
CMD15-21.....	5	CMPSCC700S.....	12	PVKM-45.....	33
CMD17-21.....	5	CR-CD0 Series.....	31	PVKM-45M.....	33
CMD28-21.....	5	CR-F10Series.....	31	PVW-45.....	33
CMD67-21.....	5	CR-L10Series.....	31	PVW-45M.....	33
CMD67-22.....	5	CR-WU Series.....	31	SL-DRV-12.....	12
CMD91-21/TR7.....	5	CR-SU0 Series.....	31	SOCKETEDLAMPS.....	24
CMD91-21/TR9.....	5	CS010.....	5	SOCKETS.....	25
CMD91-21/TR10.....	5	CS020.....	5	TL210xx-xHBSeries.....	32
CMD95-21/TR7.....	5	CS025.....	5	TL210xx-xHFSeries.....	32
CMD95-21/TR9.....	5	CS100.....	5	TL300xx-xHBSeries.....	32
CMD95-21/TR10.....	5	CS130.....	5	TL300xx-xHFSeries.....	32
CMD339.....	5	CT301.....	5		
CMD11504.....	5	CT501.....	5		
CMDxx.....	5	F30W133TB.....	28		
CMDxxx.....	5	F40WIMI29.....	28		
CMDA2.....	5	F40WIMI33.....	28		



America:
CML Innovative Technologies, Inc.
147 Central Avenue
Hackensack - NJ 07601 - USA
Tel: 1-201-489 - 8989
Fax: 1-201-489 - 6911
e-mail: americas@cml-it.com

Europe:
CML Technologies GmbH & Co. KG
Robert-Bunsen-Str. 1
67098 Bad Dürkheim - GERMANY
Tel: +49 (0) 6322 9567-0
Fax: +49 (0) 6322 9567-88
e-mail: europe@cml-it.com

Asia:
CML Innovative Technologies, Inc.
61 Aida Street
Singapore 459975
Tel: (65) 9630 - 5003
e-mail: asia@cml-it.com

www.cml-it.com