

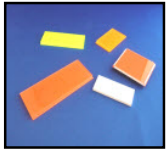

The Optoelectronic Manufacturing Corporation

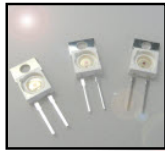

LED T5 Style Light Tube

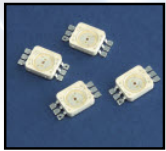

www.omc-uk.com

Technical Datasheet

An ultrabright LED lighting tube with a diameter matching that of a T5 fluorescent tube. The tube is supplied with a selection of mounting clips and fixings to facilitate use in the widest possible range of applications. No fluorescent fitting is required - power input to this product is via a safe, 24V DC wire feed into the rear of the tube. The convenient and compact tube size makes this lighting component ideal for use in place of T5 fluorescent light sources in applications such as illumination for machinery, shelf displays, backlighting, automotive lighting, display cabinets and more.

Key Features:

- Very low power consumption
- High efficiency and brightness
- Easy to install, range of fixings supplied
- Fits in the space of a T5 fluorescent
- Low voltage, 24V DC operation
- Safe - no glass, gases or filaments
- RoHS Compliant
- Easily dimmable using PWM

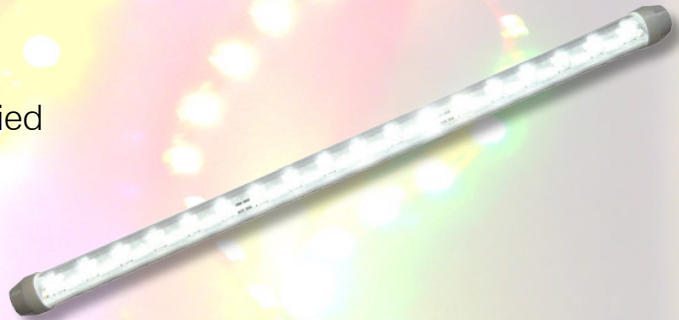

Typical Applications:

- Refrigerated vehicles
- Machinery lighting
- Food cabinet illumination
- Office and factory task lighting
- Vending machine illumination
- Point-of-sale display lighting
- Lighting for buses and trains
- Shelf and cabinet lighting
- Architectural lighting
- Refrigerators and freezers



Typical electro-optical and mechanical specifications

(Conditions: $V_{in} = 24VDC$, $T_a = 25^{\circ}C$)

Available types	1 foot, 2 foot, 3 foot, 4 foot, 5 foot									
Tube diameter	16mm									
Beam angle $2\theta_{1/2}$	60°									
Maximum Input Voltage	24V DC									
Type	1 foot		2 foot		3 foot		4 foot		5 foot	
Power consumption	2.88W		5.76W		8.64W		11.52W		14.4W	
Length (mm)	321		621		921		1221		1521	
Forward current	120mA		240mA		360mA		480mA		600mA	
Colour	Daylight	Warm	Daylight	Warm	Daylight	Warm	Daylight	Warm	Daylight	Warm
CCT (K)	6500	3500	6500	3500	6500	3500	6500	3500	6500	3500
Illuminance at 0.5m (lux)	700	530	1000	750	1000	750	1050	770	1050	770

Note: Fixings not included in above dimensions.

(Specifications subject to change without notice.)

Absolute Maximum Ratings ($T_a=25^{\circ}C$ where applicable)

Quantity	Rating
Applied voltage	24V DC
Operating Temperature Range	-20°C to +40°C
Temperature Range in Storage	-30°C to +80°C

Fixing Method A - Mini Clip

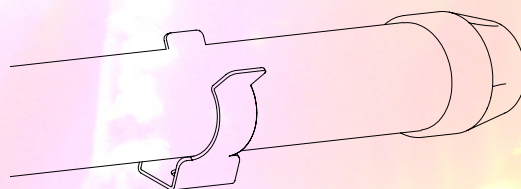
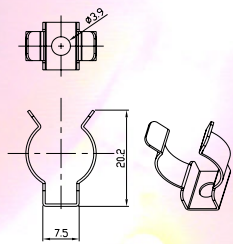

Overall dimensions when using this fixing method:
 L = Original length
 H = 22mm
 W = 19mm

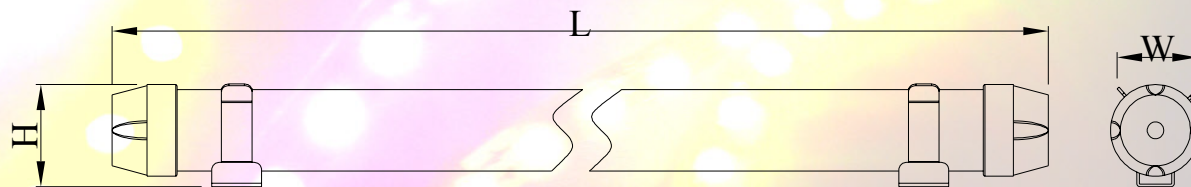

All specifications correct at time of publishing. In the interests of continual improvement, OMC reserve the right to alter specifications without notice.

Fixing Method B - Channel Clip

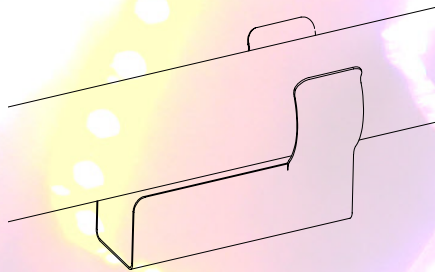
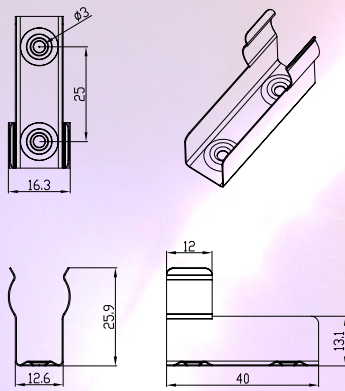

Overall dimensions when using this fixing method:
 L = Original length
 H = 27mm
 W = 18mm

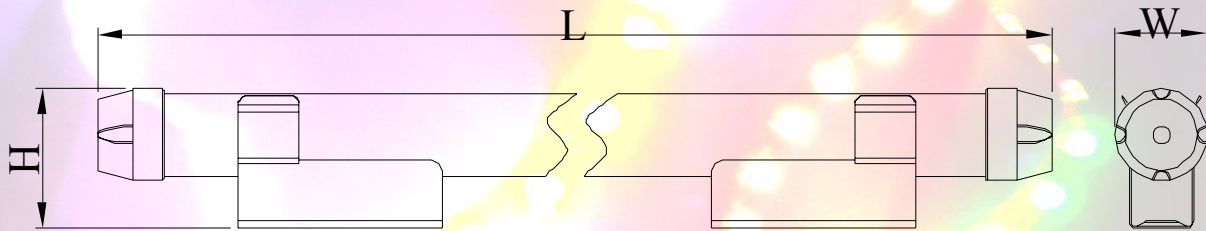

Fixing Method C - Swivel bracket

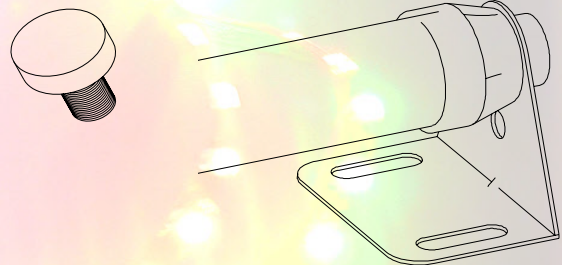
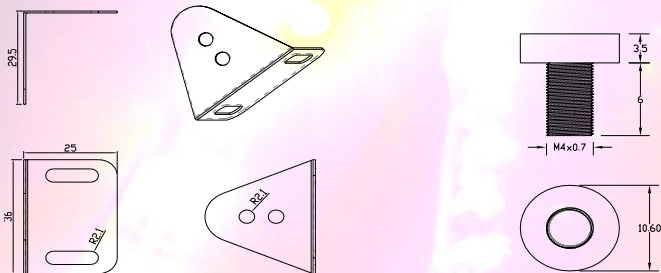

Overall dimensions when using this fixing method:

L = Original length + 11mm
 H = 30mm
 W = 36mm



Drawing without fixings

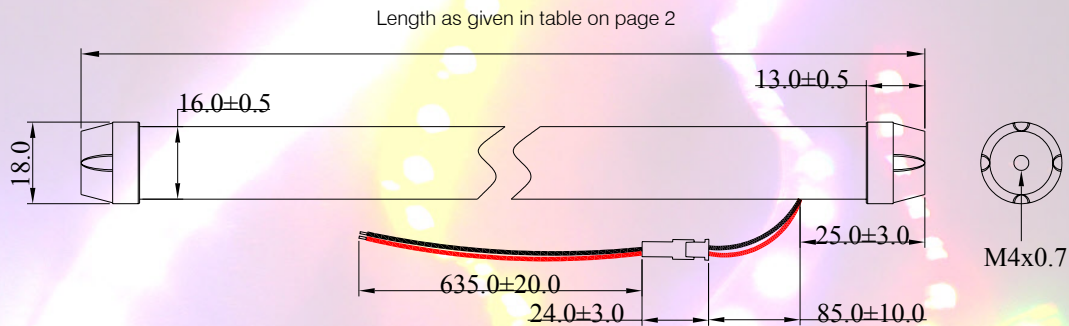

Notes:

All dimensions in this datasheet are in mm with tolerance ± 3 mm unless otherwise noted.

Application notes

- ◆ Do not apply voltages greater than 24V DC to this product or damage may occur.
- ◆ As with all semiconductor devices, it is recommended to avoid electrostatic discharge.
- ◆ If operating in ambient temperatures above 25°C, input should be de-rated to ensure optimal long-term performance. A derating curve is available on request.
- ◆ Please do not exceed the absolute maximum ratings specified in this document or damage may occur.
- ◆ If the LED packages have lenses fitted, do not use reflow soldering as the lenses should not be taken above 110°C.
- ◆ Connect anode to red wire, cathode to black wire.
- ◆ This product is not designed to be cut.
- ◆ Use of a regulated 24V DC power supply is recommended.
- ◆ This product is designed for interior use. Please do not use in damp environments.

The Optoelectronic Manufacturing Corporation (UK) Ltd.

Candela House,
Cardrew Industrial Estate,
Redruth,
Cornwall
TR15 1SS

Tel: 01209 215424

Fax: 01209 215197

General e-mail: omc-sales@omc-uk.com

www.omc-uk.com