

SDN-P DIN Rail Series

The SDN DIN Rail power supplies provide industry leading performance. Sag Immunity, transient suppression and noise tolerant, the SDN series ensures compatibility in demanding applications. Power factor correction to meet European directives, hazardous location approvals and optional redundant accessories allow the SDN series to be used in a wide variety of applications. Wide operation temperature range, high tolerance to shock and vibration and reliable design make the SDN series the preferred choice of users everywhere.

Features

- Power Factor Correction (per EN61000-3-2)
- Auto Select 115/230 Vac, 50/60 Hz Input
- Single Phase models meet SEMI F47 Sag Immunity
- Class 1, Zone 2 Hazardous Locations
 - ATEX approval on 2.5 through 10A, 24 Vdc Single Phase Models
 - ATEX approval pending on 12 Vdc and 48 Vdc single phase models
- Improved metal mounting clip
- DC OK Signal
- Adjustable Voltage
- SDN10-24-100P New Compact width (3.26")
- Parallel Capability standard on all units
- Industrial grade design
 - -10°C to 60°C operation without derating. Indefinite short circuit, overvoltage and overtemperature protection.
 - Powers high inrush loads without shutdown or foldback
 - Rugged metal case and DIN connector
- SDN2.5-24-100P and SDN4-24-100LP meet NEC Class 2
- Narrow width on rail for space critical applications
- User-friendly front panel
 - Large, rugged, accessible, multiple connection screw terminations
 - Easy installation
- Broad range of product to fit almost any application – 2.5 A through 40 A, 24 Vdc
- Single and three phase inputs available
- 12 Vdc and 48 Vdc single phase models available
- Highly efficient >90% switching technology
- High MTBF and reliability
- RoHS compliant



Related Products

- SDP™ Series
- SFL Series
- SCP Series
- SCL Series
- SDU UPS

Applications

- Industrial/Machine Control
- Process Control
- Conveying Equipment
- Material Handling
- Vending Machines
- Packaging Equipment
- DeviceNet™
- Amusement Park Equipment
- Semiconductor Fabrication Equipment

Accessories

- Chassis Mount Bracket (SDN-PMBRK2)

Visit our website at www.solahd.com or contact Technical Services at (800) 377-4384 with any questions.

SDN-P Specifications (Single Phase), 24 Vdc Output



Description	Catalog Number				
	SDN 2.5-24-100P	SDN 4-24-100LP	SDN 5-24-100P	SDN 10-24-100P	SDN 20-24-100P
Input					
Nominal Voltage	115/230 Vac auto select				
-AC Range	85-132/176-264 Vac				
-DC Range ¹	90-375 Vdc	210-375 Vdc			N/A
-Frequency	47 - 63 Hz				
Nominal Current ²	1.3 A. / 0.7 A	2.1 A / 1.0 A	2.2 A / 1.0 A	5 A / 2 A typ.	9 A / 3.9 A
-Inrush current max.	typ. < 25 A		typ. < 20 A		typ. < 40 A
Efficiency (Losses ³)	> 87.5% typ. (8.6 W)	> 88% typ. (13.1 W)	> 88% typ. (16.4 W)	> 88% typ. (32.7 W)	> 90% typ. (48 W)
Power Factor Correction	Units Fulfill EN61000-3-2				
Output					
Nominal Voltage	24 Vdc (22.5 - 28.5 Vdc adj.)	24 Vdc (22.5 - 25.5 Vdc adj.)	24 Vdc (22.5 - 28.5 Vdc adj.)		
-Tolerance	< ±2% overall (combination Line, load, time and temperature related changes)				
-Ripple ⁴	< 50 mVpp				
Overvoltage Protection	> 30 Vdc, but < 33 Vdc, auto recovery				
Nominal Current	2.5 A (60 W)	3.8 A (92 W)	5 A (120 W)	10 A (240 W)	20 A (480 W)
-Current Limit	Fold Forward (Current rises, voltage drops to maintain constant power during overload up to max peak current)				
Holdup Time ⁵	> 50 ms	> 100 ms			
Parallel Operation	Single or Parallel use is selectable via Front Panel Switch (SDN 2.5, 4 should not be used in parallel as Class 2 rating would be violated.)				
General					
EMC: -Emissions	EN61000-6-3, -4; Class B EN55011, EN55022 Radiated and Conducted including Annex A.				
-Immunity	EN61000-6-1, -2; EN61000-4-2 Level 4, EN61000-4-3 Level 3; EN61000-4-6 Level 3; EN61000-4-4 Level 4 input and Level 3 output; EN61000-4-5 Isolation Class 4, EN61000-4-11;				
Approvals	EN60950; UL508 Listed, cULus; UL60950, cRUus, CE (LVD 73/23 & 93/68/EEC). EN61000-3-2, IEC60079-15 (Class 1, Zone 2, Hazardous Location, Groups A, B, C, D w/ T3A temp class up to 60°C Ambient.) SEMI F47 Sag Immunity. SDN 2.5 & SDN 4 - UL60950 testing to include approval as Class 2 power supply in accordance with UL1310.				
Temperature	Storage: -25°C...+85°C Operation. -10°-60°C full power with operation to 70°C possible with a linear derating to half power from 60°C to 70°C (Convection cooling, no forced air required). Operation up to 50% load permissible with sideways or front side up mounting orientation.				
Humidity	The relative humidity is < 90% RH, noncondensing; IEC 68-2-2, 68-2-3.				
MTBF:	> 820,000 hours	> 640,000 hours		> 600,000 hours	> 510,000 hours
- Standard	Bellcore Issue 6 Method 1 Case 3 @ 40°C				MIL STD 217F @ 30°C
Warranty	5 years				
General Protection/ Safety	Protected against continuous short-circuit, overload, open-circuit. Protection Class 1 (IEC536), degree of protection IP20 (IEC 529) Safe low voltage: SELV (acc. EN60950)				
Status Indicators	Green LED and DC OK signal (N.O. Solid State Contact rated 200 mA / 60 Vdc)				
Installation					
Fusing -Input	Internally fused. External 10 A slow acting fusing for the input is recommended to protect input wiring.				
-Output	Outputs are capable of providing high currents for short periods of time for inductive load startup or switching. Fusing may be required for wire/loads if 2x Nominal O/P current rating cannot be tolerated. Continuous current overload allows for reliable fuse tripping.				
Mounting	Simple snap-on system for DIN Rail TS35/7.5 or TS35/15 or chassis-mounted (optional screw mounting set SDN-PMBRK2 required).				
Connections	Input: IP20-rated screw terminals, connector size range: 16-10 AWG (1.5-6 mm ²) for solid conductors. 16-12 AWG (0.5-4 mm ²) for flexible conductors. Output: Two connectors per output, connector size range: 16-10 AWG (1.5 - 6 mm ²) for solid conductors.				
Case	Fully enclosed metal housing with fine ventilation grid to keep out small parts.				
-Free Space	25 mm above and below, 25 mm left and right, 10 mm in front		25 mm above and below, 25 mm left and right, 15 mm in front		70 mm above and below, 25 mm left and right, 15 mm in front
H x W x D (inches/mm)	4.88. x 1.97 x 4.55 (124 x 50 x 116)	4.88 x 2.56 x 4.55 (124 x 65 x 116)		4.88 x 3.26 x 4.55 (124 x 83 x 116)	4.88 x 6.88 x 4.55 (124 x 175 x 116)
Weight (lbs/kg)	1 (.45)	1.5 (.68)		2.2 (0.1)	3 (1.36)

- Not UL listed for DC input.
- Input current ratings are conservatively specified with low input, worst case efficiency and power factor.
- Losses are heat dissipation in watts at full load, nominal input line.
- Ripple/noise is stated as typical values when measured with a 20 MHz, bandwidth scope and 50 Ohm resistor.
- Full load, 100 Vac Input @ T_{amb} = +25°C

Visit our website at www.solahd.com or contact Technical Services at (800) 377-4384 with any questions.

SDN-P Specifications (Single Phase), 12 Vdc and 48 Vdc Output

 CE Ex II 3G DEMKO 06
ATEX 05 21715U

Description	Catalog Number		
	SDN 9-12-100P	SDN 5-48-100P	SDN 16-12-100P
Input			
Nominal Voltage	115/230 Vac auto select		
-AC Range	85-132/176-264 Vac		
-DC Range ¹	210-375 Vdc		
-Frequency	47-63 Hz, 400 Hz		
Nominal Current ²	2.0 A / 1.5 A	4 A / 2.3 A	3.3 A / 1.7 A
-Inrush current max.	Typ. < 20 A		typ. < 40 A
Efficiency ² (Losses ³)	> 84% typ. (17.28 W)	> 88% typ. (28.8 W)	> 84% typ. (30.72 W)
Power Factor Correction	Units fulfill EN61000-3-2		
Output			
Nominal Voltage	12 V (11.8-15.2 Vdc Adj.)	48 V (35.8 - 52 Vdc Adj.)	12 V (11.6-14.0 Vdc Adj.)
Tolerance	< ±2 % overall (combination Line, load, time and temperature related changes)		
-Line Regulation	< 0.5%		
-Load Regulation	< 0.5%		
-Time & Temp. Drift	< 1%		
Ripple ³	< 50 mVpp		
Overvoltage Protection	< 16 Vdc with auto-recovery	< 60 Vdc with auto-recovery	< 16 Vdc with auto-recovery
Nominal Current	9 A (108 W)	5 A (240 W)	16 A (192 W)
-Current Limit ⁴	110% of nominal - Fold Forward (Current rises, voltage drops to maintain constant power during overload up to max peak current)		
Holdup Time ⁵	>20 ms (Full load, 100 Vac Input @ T _{amb} =+25°C) to 95% output Voltage		
Parallel Operation	Supplies will not be damaged with parallel operation		
Power Back Immunity	16 Vdc	60 Vdc	16 Vdc
General			
EMC: -Emissions	EN61000-6-3, EN61204-3, EN55022 Class B, EN61000-3-2, EN61000-3-3		
-Immunity	EN61000-6-2, EN61204-3, EN55024, IEC61000-4-2, IEC61000-4-3, IEC61000-4-4, IEC61000-4-5, IEC61000-4-6, IEC61000-4-8, IEC61000-4-11		
Approvals	UL508 Listed, cULus; UL 60950-1, cURus; CE (LVD 73/23 & 93/68/EEC), (EMC 89/336 & 93/68/EEC). EN61000-3-2; UL 60079-15 pending (Class 1, Zone 2 hazardous location, Groups IIA, IIB, IIC w/ T3 temp. class up to 60°C Ambient.); EN60079-15 (ATEX); SEMI F47 Sag Immunity, RoHS		
Temperature	Storage: -25 to +85°C, Operation -10 to +60°C full power; with linear derating to half power from 60 to 70°C (Convection cooling, no forced air required). Operation up to 50% load permissible with sideways or front side up mounting orientation.		
Humidity	< 90% RH, non-condensing; IEC 68-2-2, 68-2-3		
MTBF:	>500,000 hrs		
- Standard	Telcordia/Bellcore, Issue Case 3 @25°C		
Warranty	5 years		
General Protection/Safety	Protected against continuous short -circuit, continuous overload, continuous open circuit. Protection Class 1 (IEC536), Degree of Protection IP20 (IEC 529) Safe low voltage: SELV (acc. EN60950)		
Status Indicators (Visual)	Green LED on when V _{out} > 75% (with ± 5% tolerance) of nominal output voltage		
Status Indicators (Relay)	Normally Open solid state relay - signal active when V _{out} >70% of nominal output voltage (rated up to 200 mA, 60 Vdc)		
Installation			
Fusing -Input	Internally fused		
-Output	Outputs are capable of providing high currents for short periods of time for inductive load startup or switching. Fusing may be required if Nominal O/P current rating cannot be tolerated. Continuous current overload allows for reliable fuse tripping.		
Mounting	Simple snap-on to DIN TS35/7.5 or TS35/15 rail system. Unit should handle normal shock and vibration of industrial use and transportation without falling off the rail.		
Connections	Input: Screw terminals, connector size range: 16-10 AWG (1.5-6mm ²) for solid conductors. Output: Two terminals per output, connector size range: 16-10 AWG (1.5-6mm ²) for solid conductors.		
Case	Fully enclosed metal housing with fine ventilation grid to keep out small parts.		
-Free Space	70 mm above and below, 25 mm left and right, 15mm in front		
H x W x D (inches/mm)	4.88 x 2.56 x 4.55 (124 x 65 x 116)	4.88 x 3.26 x 4.55 (124 x 83 x 116)	
Weight (lbs/kg)	2.4 (1.05)	3.3 (1.48)	

1. Input current ratings are specified with low input, line conditions and worst case efficiency values. Input current at nominal input settings will be typically half these values.

2. Losses are heat dissipation in watts at full load, nominal line.

3. Ripple/ noise is stated as typical values when measured with a 20 MHz bandwidth scope and 50 Ohm resistor.

4. Unit shall not shutdown or 'hiccup' during overload or short circuit. Maximum current value shown shall be maintained indefinitely without damage to the supply. Voltage shall drop according to amount of overload to protect supply from damage.

Visit our website at www.solahd.com or
contact Technical Services at (800) 377-4384 with any questions.

SDN-P Specifications (Three Phase)

Description	Catalog Number				
	SDN 5-24-480	SDN 10-24-480	SDN 20-24-480C	SDN 30-24-480	SDN 40-24-480
Input					
Nominal Voltage	1Ø or 3Ø 380-480 Vac		1Ø or 3Ø 380 - 480 Vac ¹	3Ø 380 - 480 Vac	
-AC Range	340 - 576 Vac				
-DC Range ²	450 - 820 Vdc				
-Frequency	47 - 63 Hz				
Nominal Current ³	0.5 A	0.8 A	1.5 A	2.0 A	3.0 A
-Inrush current max.	typ. < 18 A			typ. < 30 A	
Efficiency (Losses ⁴)	> 90% typ. (12 W)	> 90% typ. (48 W)		> 90% typ. (72 W)	> 90% typ. (96 W)
Power Factor Correction	Units Fulfill EN61000-3-2				
Output					
Nominal Voltage	24 Vdc (22.5 - 28.5 Vdc adj.)				
-Tolerance	< ±2% overall (combination Line, load, time and temperature related changes)				
-Ripple ⁵	< 50 mVpp				
Overvoltage Protection	> 30 Vdc, but < 33 Vdc, auto recovery				
Nominal Current	5 A (120 W)	10 A (240 W)	20 A (480 W)	30 A (720 W)	40 A (960 W)
-Peak Current	6A, 2x Nominal Current < 2 sec.	12A, 2x Nominal Current < 2 sec.	25A, 2x Nominal Current < 2 sec.	35A, 2x Nominal Current < 2 sec.	45A, 2x Nominal Current < 2 sec
-Current Limit	Fold Forward (Current rises, voltage drops to maintain constant power during overload up to max peak current)				
Holdup Time ⁶	> 40 ms		> 28 ms	> 20 ms	
Parallel Operation	5A through 30A units may be passively paralleled by selecting the "P" position of the switch on the unit. The SDN 40 contains active current balancing.				
General					
EMC: -Emissions	EN61000-6-3, -4; Class B EN55011, EN55022 Radiated and Conducted including Annex A.				
-Immunity	EN61000-6-1, -2; EN61000-4-2 Level 4, EN61000-4-3 Level 3; EN61000-4-6 Level 3; EN61000-4-4 Level 4 input and Level 3 output; EN61000-4-5 Isolation Class 4, EN61000-4-11;				
Approvals	CB Scheme, EN60950; UL508 Listed, cULus; UL60950, cRUus, CE (LVD 73/23 & 93/68/EEC). EN61000-3-2, UL60079-15 Class 1, Zone 2 Hazardous Location, Groups IIA, IIB, IIC w/T3 temp class up to 60°C Ambient.				
Temperature	Storage: -25°C...+85°C Operation. -10°C -60°C full power with operation to 70°C possible with a linear derating to half power from 60°C to 70°C (Convection cooling, no forced air required). Operation up to 50% load permissible with sideways or front side up mounting orientation. The relative humidity is < 90% RH, noncondensing; IEC 68-2-2, 68-2-3.				
MTBF:	> 1,110,000 hours	> 940,000 hours	> 550,000 hours	> 620,000 hours	> 490,000 hours
- Standard	MIL STD 217F @ 30°C				
Warranty	5 years				
General Protection/ Safety	Protected against continuous short-circuit, overload, open-circuit. Protection Class 1 (IEC536), degree of protection IP20 (IEC 60529) Safe low voltage: SELV (acc. EN60950)				
Status Indicators	Green LED on when V _{out} = 18V or greater.				
Installation					
Fusing -Input	Internally fused				
-Output	Outputs are capable of providing high currents for short periods of time for inductive load startup or switching. Fusing may be required for wire/loads if 2x Nominal O/P current rating cannot be tolerated. Continuous current overload allows for reliable fuse tripping.				
Mounting	Simple snap-on system for DIN Rail TS35/7.5 or TS35/15 or chassis-mounted (optional screw mounting set SDN-PMBRK2 required).				
Connections ⁷	Input: IP20-rated screw terminals, connector size range: 16-10 AWG (1.5-6 mm ²) for solid conductors. 16-12 AWG (0.5-4 mm ²) for flexible conductors. Output: Two connectors per output, connector size range: 16-10 AWG (1.5-6 mm ²) for solid conductors.				
Case	Fully enclosed metal housing with fine ventilation grid to keep out small parts.				
-Free Space	25 mm above and below, 25 mm left and right, 15 mm in front		70 mm above and below, 25 mm left and right , 15 mm in front		
H x W x D (inches/mm)	4.88 x 2.91 x 4.55 (124 x 73 x 116)	4.88 x 3.5 x 4.55 (124 x 89 x 116)	4.88 x 5.9 x 4.55 (124 x 150 x 116)	4.88 x 9.72 x 4.55 (124 x 247 x 116)	4.88 x 11.1 x 4.55 (124 x 282 x 116)
Weight (lbs/kg)	1.7 (.77)	2.16 (.98)	3.97 (1.8)	4 (1.81)	6.6 (2.99)

1. For the SDN 20-24-480C, single phase input is permissible, but output is derated to 75% (15 Amps @ 24 Vdc).
 2. Not UL listed for DC input.
 3. Input current ratings are conservatively specified with low input, worst case efficiency and power factor.

4. Losses are heat dissipation in watts at full load, nominal input line.
 5. Ripple/noise is stated as typical values when measured with a 20 MHz, bandwidth scope and 50 Ohm resistor.
 6. Full load, 100 Vac Input @ T_{amb} = +25°C
 7. For the SDN 40-24-480, output: one (+) two (-) connectors, size range 16-5 AWG (1.5016 mm²) solid conductor.

Visit our website at www.solahd.com or contact Technical Services at (800) 377-4384 with any questions.

SDN-P Series Dimensions

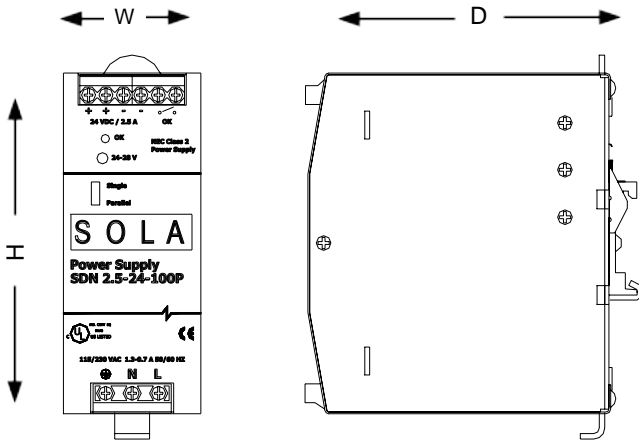

Catalog Number	Dimensions – inches (mm)		
	H	W	D
12 Vdc			
SDN 9–12–100P	4.88 (124)	2.56 (65)	4.55 (116)
SDN 16–12–100P	4.88 (124)	3.26 (83)	4.55 (116)
24 Vdc			
SDN 2.5–24–100P	4.88 (124)	1.97 (50)	4.55 (116)
SDN 4–24–100LP	4.88 (124)	2.56 (65)	4.55 (116)
SDN 5–24–100P	4.88 (124)	2.56 (65)	4.55 (116)
SDN 5–24–480	4.88 (124)	2.91 (73)	4.55 (116)
SDN 10–24–100P	4.88 (124)	3.26 (83)	4.55 (116)
SDN 20–24–100P	4.88 (124)	6.88 (175)	4.55 (116)
48 Vdc			
SDN 5–48–100P	4.88 (124)	3.26 (83)	4.55 (116)

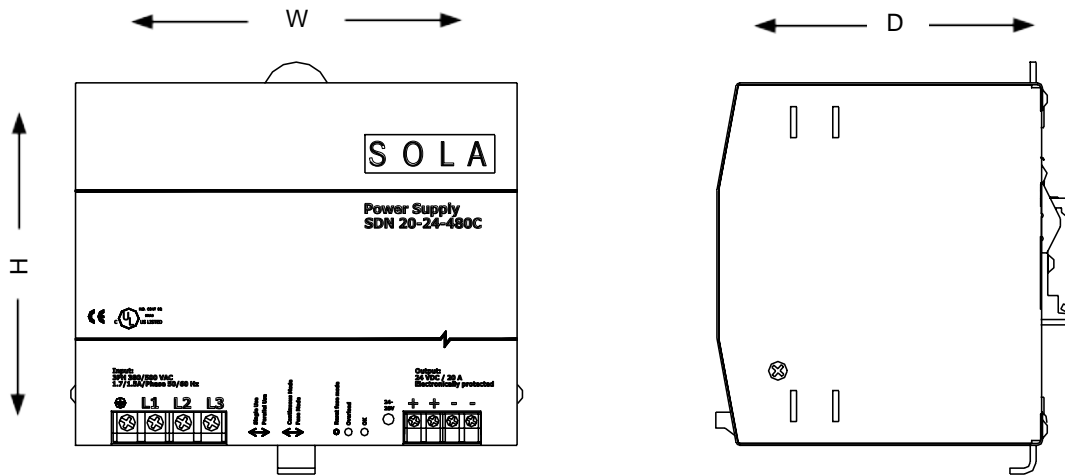

Catalog Number	Dimensions – inches (mm)		
	H	W	D
SDN 10–24–480	4.88 (124)	5.90 (150)	4.55 (116)
SDN 30–24–480	4.88 (124)	9.72 (247)	4.55 (116)
SDN 40–24–480	4.88 (124)	11.10 (282)	4.55 (116)

Visit our website at www.solahd.com or contact Technical Services at (800) 377-4384 with any questions.

SDN-P Series Mounting

DIN Rail Mounting

Snap on the DIN Rail:

1. Tilt unit slightly backwards
2. Put it onto the DIN Rail
3. Push downwards until stopped
4. Push at the lower front edge to lock
5. Shake the unit slightly to ensure that the retainer has locked

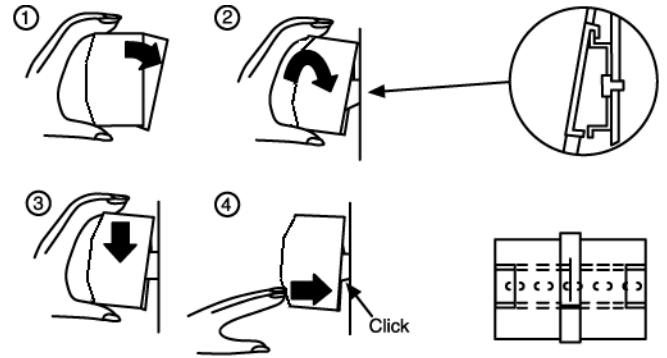

Alternative Panel Mount: Using the optional SDN-PMBRK2 accessory, the unit can be screw mounted to a panel.

Detachment from DIN Rail:

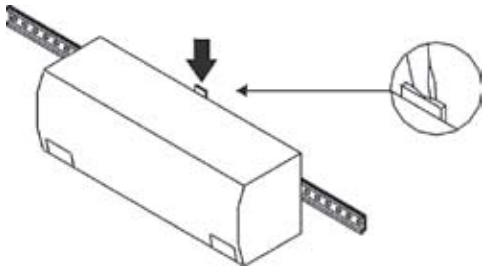

Chassis Mounting

Instead of snapping a Sola SDN™ unit on the DIN Rail, you can also attach it using the screw mounting set SDN-PMBRK2.

This set consists of two metal brackets, which replace the existing two aluminum profiles.

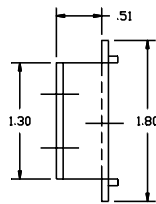
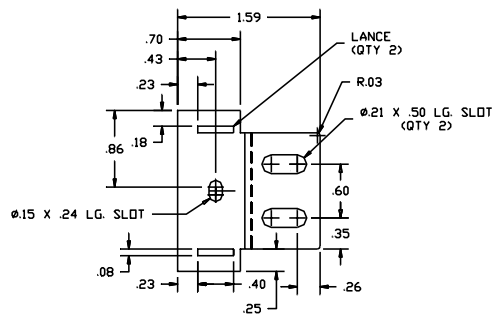

Dimensions

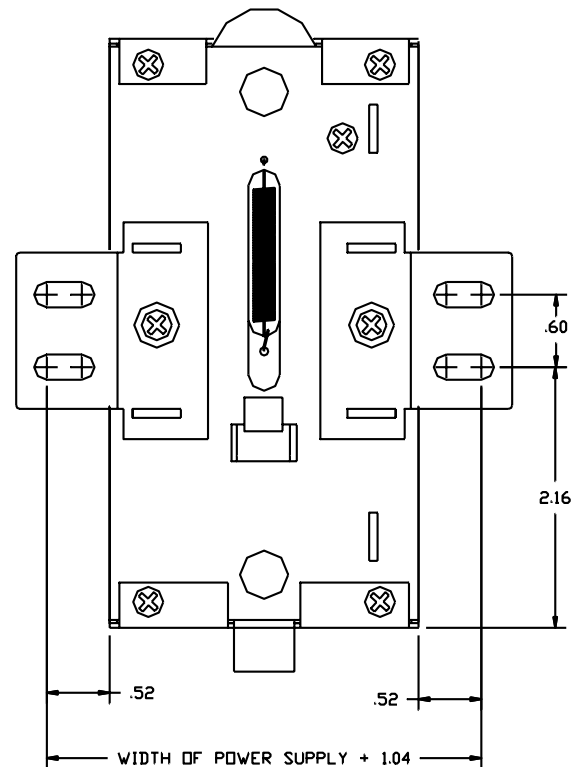

Visit our website at www.solahd.com or contact Technical Services at (800) 377-4384 with any questions.