

Description : **T-1½(5mm) Lead-free Wedge base lamp 12V 1W**

Dimensional Characteristics : All dimensions in mm

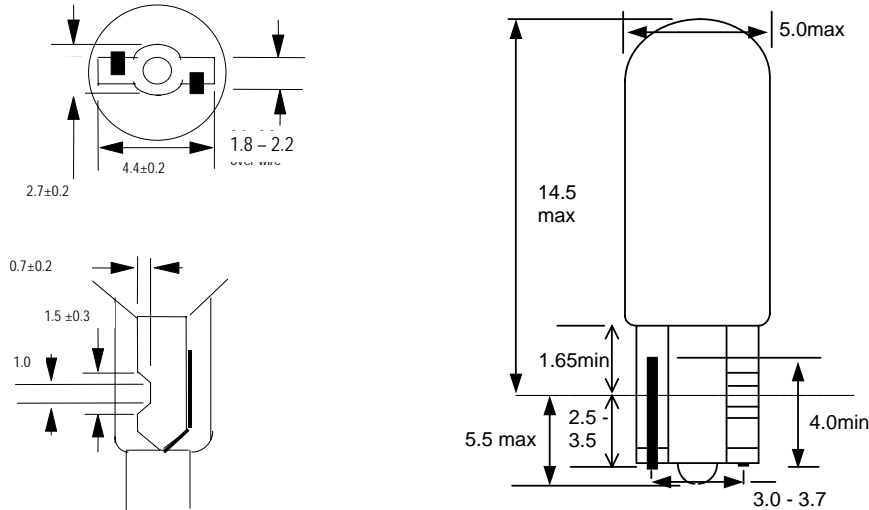

Marking

CML 12V 1W

Performance Characteristics @ 12 volts

	Nom	Min	Max
Current(mA)	83	75	91
Light output(Lm)	3.00	2.25	3.75
Life(hrs)	5,000		

Issue # 1

Date 07/03/06