

Description : **T-1½(5mm) Lead-free Wedge base lamp 28V 40mA**

Dimensional Characteristics : All dimensions in mm

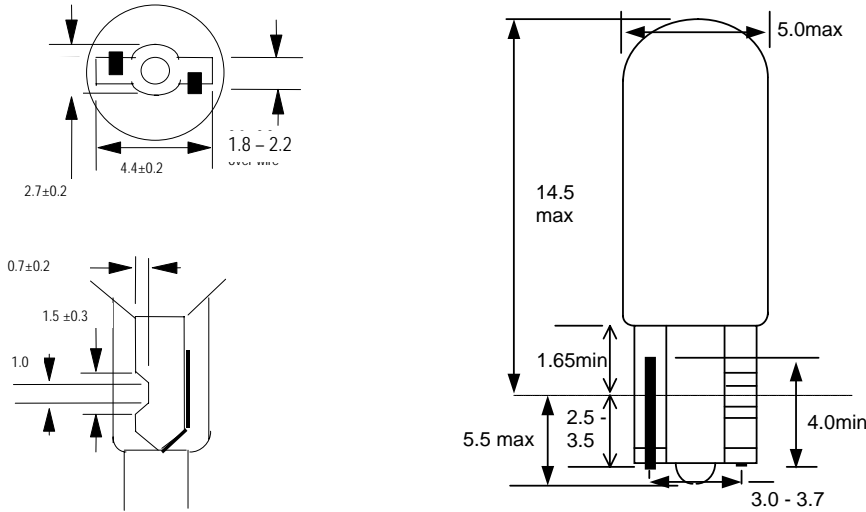

Marking

CML 28V 40mA

Performance Characteristics @ 28 volts

	Nom	Min	Max
Current(mA)	40	36	44
Light output(Lm)	3.8	2.9	4.7
Life(hrs)	10,000		

Issue # 1

Date 13/03/06