

800-262-IDEC

www.IDEC.com/usa/SpiderLights

(Actual Size)

DOME LENS

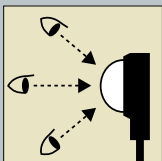
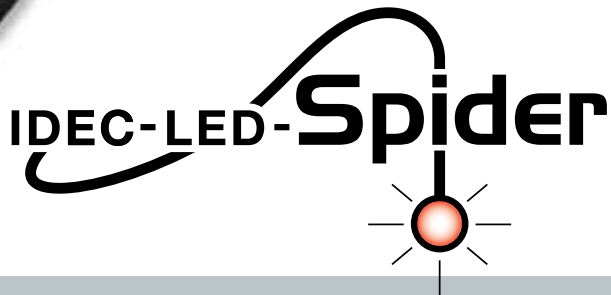

Good Visibility
From the front and the side.

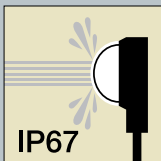

IP67
IP67 Protection
Can be used in environments exposed to water.

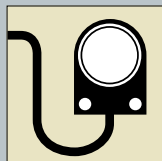

Cable Wiring
Direct wiring ensures waterproof characteristics.

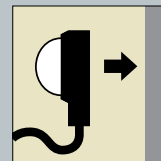

Direct Surface Mounting
Requires only a small space behind the mounting surface. Can be installed without concern for other components behind mounting area.

Surface Mount Indicators LH Series

New type of indicator for mounting on equipment or panel surfaces



FLAT LENS

(Actual Size)

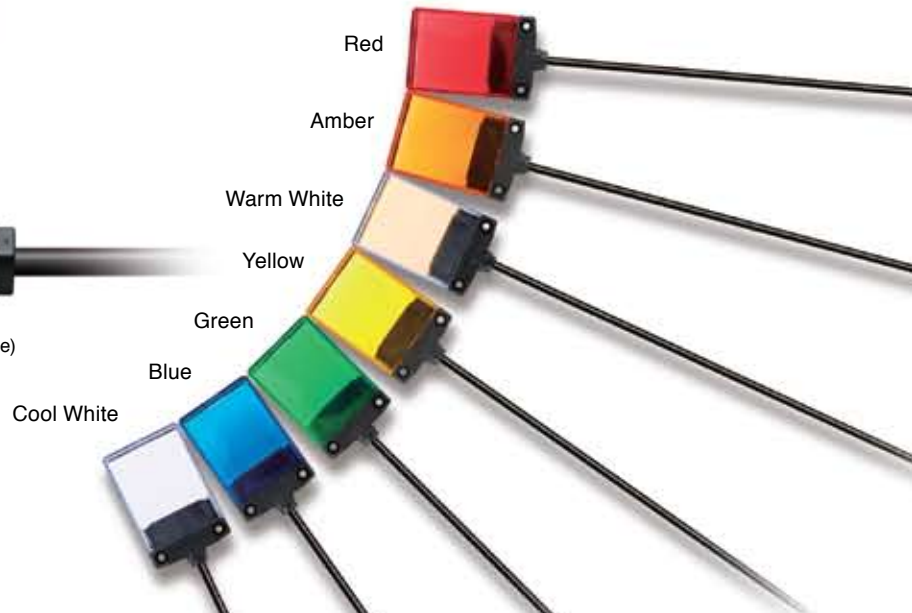

Red/green two color alternate lights also available.

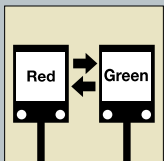

Red/Green
Two-color alternate illumination available.

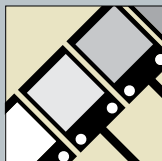

Seven Colors
Amber, blue, green, cool white, red, warm white, & yellow.

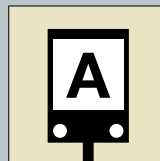

Legends
Marking film can be inserted into the flat type lens.

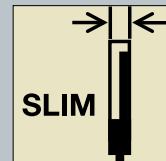

Slim Profile
Can be installed in small areas easily.



LH Series Surface Mount Indicators

Innovative indicators in a slim & stylish design.
Reduces installation space.

- Direct mounting on surfaces such as panels, aluminum frames, and walls using screws.
- Surface mount style does not affect the placement of other components. Requires only a small space behind the mounting surface for screws and nuts.
- Slim design well suited for installation in small spaces.
- Direct cable wiring style ensures waterproof characteristics. 1m, 3m, and 5m cables available.
- IP67 (IEC60529) rated.
- Excellent visibility from the front and from the side.
- Legends and symbols can be printed on marking film to customize flat type.
- Red/Green two-color alternate illumination available.



Standards

Standards	Marks	File No. or Organization
EN 60598-2-1		TÜV SÜD
EN 60598-2-1 EN 60947-5-1		EC Low Voltage Directive
E68961		UL, cUL

LH series surface mount indicators are approved by TÜV as class III lighting fixtures.

Specifications

Rated Insulation Voltage (Ui)	32V
Rated Voltage	24V AC/DC
Operating Voltage Range	24V AC/DC ±10%
Rated Current	17 mA
Maximum Current Draw	0.6W (25 mA)
Illumination Color	A (amber), G (green), PW (cool white), R (red), S (blue), W (warm white), Y (yellow) R (red) /G (green) alternate
LED Lamp Life	Approx. 50,000 hours (When used on complete DC at 25°C, brightness reduces to 50% of the initial intensity.)

Specifications



Applicable Standards	IEC 60947-1, IEC 60947-5-1, EN 60598-2-1, EN 60947-5-1 UL508, CSA C22.2 No.14
Operating Temperature	-20 to +55°C (no freezing)
Operating Humidity	45 to 85% RH (no condensation)
Storage Temperature	-30 to +80°C (no freezing)
Impulse Withstand Voltage (illuminating part)	800V
Insulation Resistance	Between live and dead parts: 100 MΩ minimum
Dielectric Strength	Between live and dead parts: 2000V, 50/60Hz, 1 minute
Pollution Degree	3
Vibration Resistance	60m/s ² , 5 to 55 Hz, amplitude 0.5 mm
Shock Resistance	1000m/s ²
Cable Tensile Strength	90N minimum
Degree of Protection	IP67 (IEC 60529)
Housing Color	Black
Cable	UL20276, 24 AWG 2-core (one-color) 3-core (2-color alternate)
Cable Outside Diameter	ø4.1mm
Allowable Cable Bending Radius	24.6mm minimum
Weight	50g (1m cable)



www.IDEC.com/usa/SpiderLights

Dome Type

Part Numbers

Shape	Cable	Part No.	② Illumination Color
Dome $\phi 37$ One Color 	1m	LH1D-D2HQ4C10-②	Specify a color code in place of ② in the Part No. A: amber G: green PW: cool white R: red S: blue W: warm white Y: yellow
	3m	LH1D-D2HQ4C30-②	
	5m	LH1D-D2HQ4C50-②	
Dome $\phi 37$ Red/Green 2-color alternate 	1m	LH1D-D2HQ4C10-RG	R (red) / G (green) 2-color alternate illumination
	3m	LH1D-D2HQ4C30-RG	
	5m	LH1D-D2HQ4C50-RG	

Dimensions

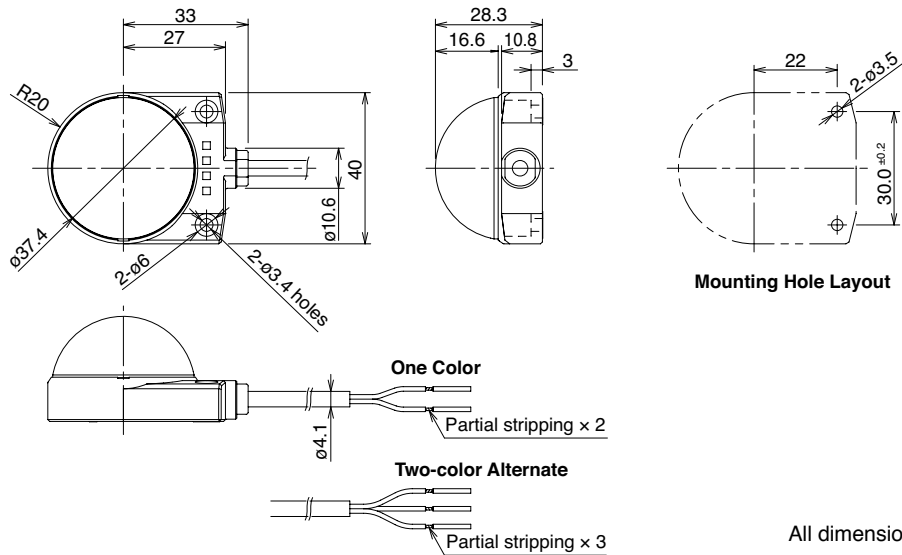

All dimensions in mm.

Internal Circuit

• One-color Illumination

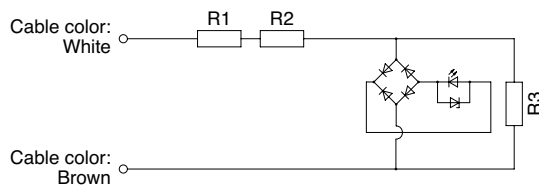

• Two-color Alternate Illumination

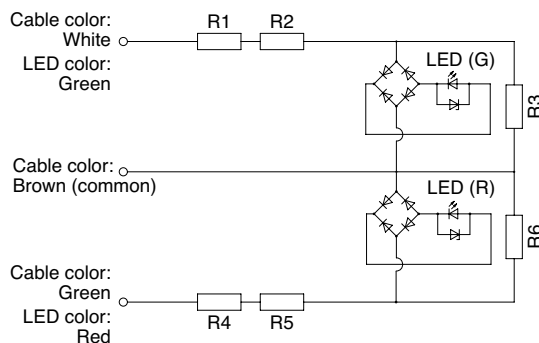

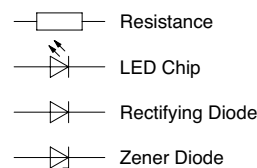

Lens Colors

Illumination Type	Illumination Color	Lens Color
One Color	Amber	Amber
	Blue	Blue
	Green	Green
	Cool White	Clear (Note)
	Red	Red
	Warm White	Clear (Note)
Two-color Alternate	Red/Green	Clear (Note)



Note: Because lenses have a white diffusion cover inside, cool white, warm white, and red/green types look white when the light is off.

Flat Type

Shape	Cable	Part Number	② Illumination Color
Flat One Color Full 	1m	LH1D-H2HQ4C10-②	Specify a color code in place of ② in the Part No. A: amber G: green PW: cool white R: red S: blue W: warm white Y: yellow
	3m	LH1D-H2HQ4C30-②	
	5m	LH1D-H2HQ4C50-②	
Flat Red/Green 2-color Alternate 	1m	LH1D-H2HQ4C10-RG	R (red) / G (green) 2-color alternate illumination
	3m	LH1D-H2HQ4C30-RG	
	5m	LH1D-H2HQ4C50-RG	

Dimensions

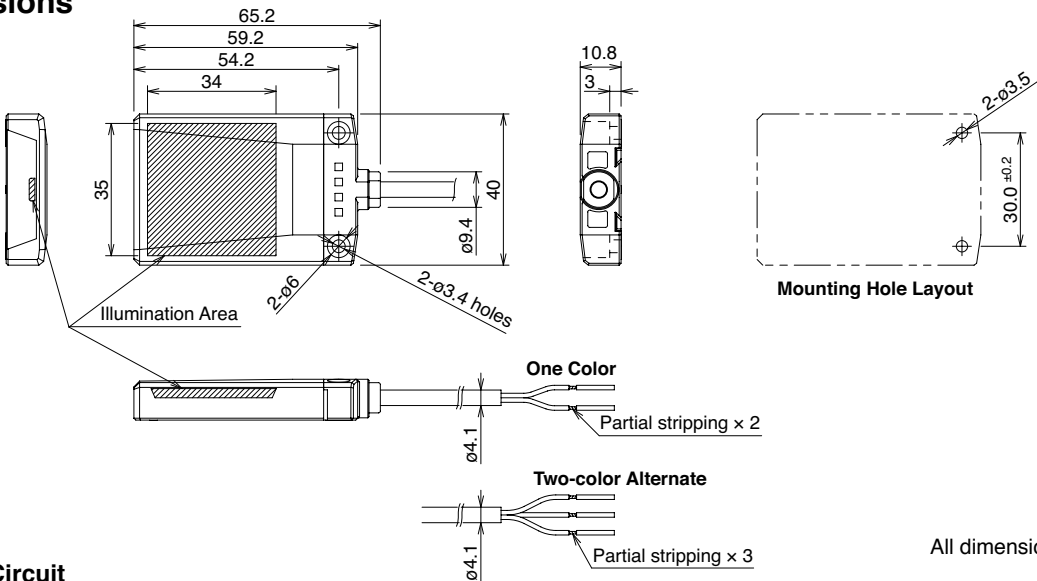

All dimensions in mm.

Internal Circuit

• One-color Illumination

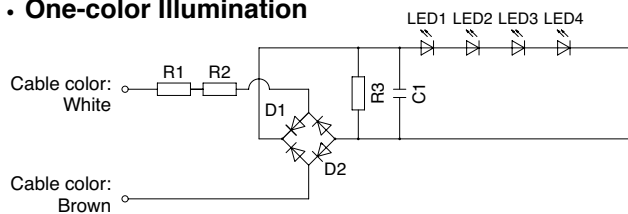

• Two-color Alternate Illumination

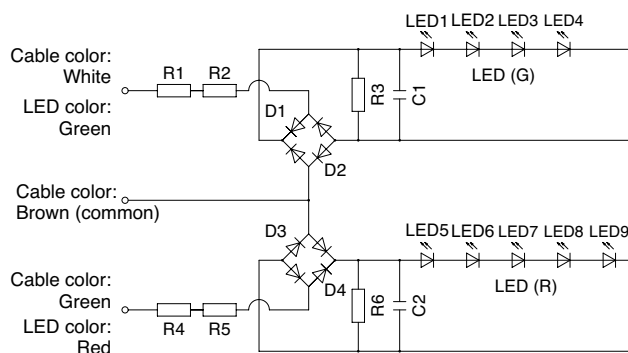

Lens Colors

Illumination Type	Illumination Color	Lens Color
One Color	Amber	Amber
	Blue	Blue
	Green	Green
	Cool White	Clear
	Red	Red
	Warm White	Clear
Two-color Alternate	Red/Green	Clear

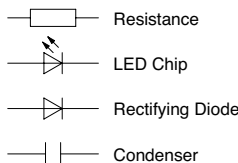

800-262-IDEC

www.IDEC.com/usa/SpiderLights

Replacement Parts

Shape	Material	Part Number	② Lens Color
 Lens (flat type)	Polyarylate	LH9Z-1DLH2-②	For flat type. Specify a color code in place of ② in the Part No. A: amber G: green C: clear R: red S: blue Y: yellow Note: Use C (clear) lens for R/G (red/green alternate), W (warm white), or PW (cool white) illumination.

Instructions

Panel Mounting

Using two M3 screws, install the LH indicator to a mounting surface. Tighten the screws to a torque of 0.6 N·m maximum. Mounting screws are not provided and must be supplied by the user.

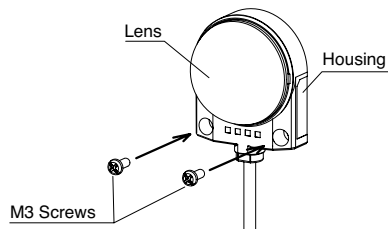

Note: The dome lens is not removable. Do not attempt to remove the lens, otherwise damage will occur.

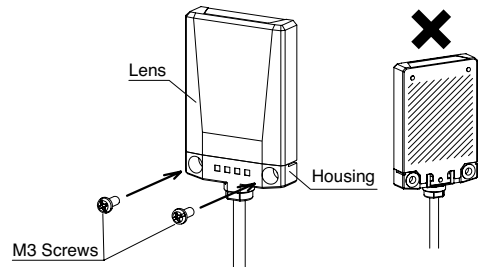

Note 1: Do not install the LH indicator by attaching the lens only, such as by taping down on the lens as the internal components may come loose.

Note 2: Make sure that the back of the indicator is securely attached to the mounting surface so that the lens cannot be easily removed.

Inserting Marking Film into Flat Type Lens

1. Insert a flat screwdriver into the groove between the base and lens.

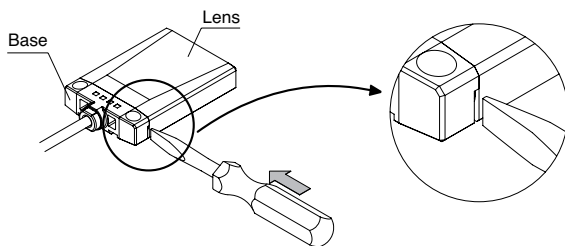

2. Twist the screwdriver and disengage the lens from the base.

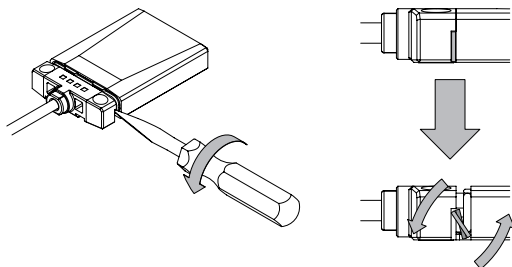

3. Remove the lens from the base.

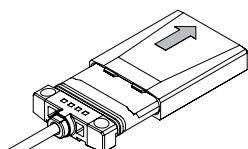

4. Insert the edge of a marking film into the gap between the base and the diffusion plate, and place the marking film on top of the diffusion plate.

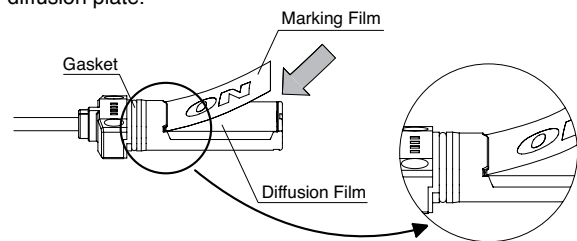

5. Replace the lens. Ensure that the lens is installed snugly.

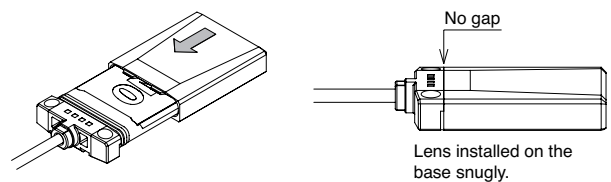

Note 1: Do not touch the gasket, as this may affect its waterproof characteristics.

Note 2: Do not touch the diffusion plate.

Markings

Legends and symbols can be printed on marking film that can be used with the flat lens. One 0.1mm-thick film can be inserted.

Marking films are not included and must be supplied by the user.
Recommended marking film: Polyester

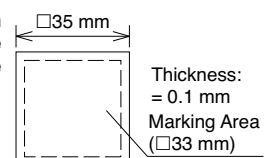

Applications

Conventional Indicators

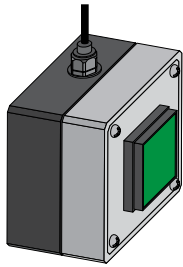

IDEC LED Spider

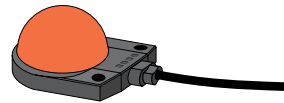
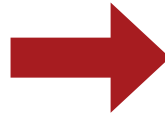
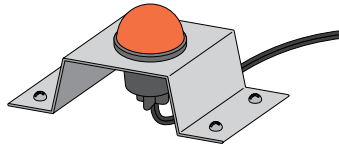
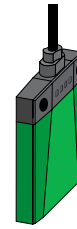

Picking Application

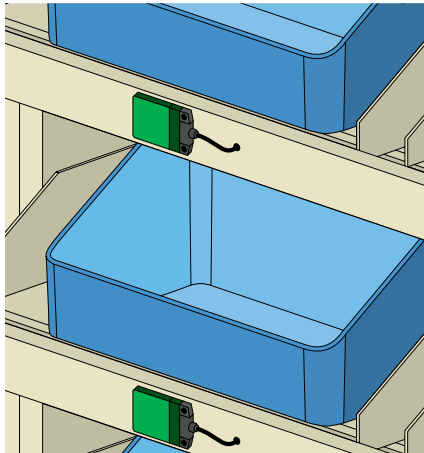

Door Monitoring

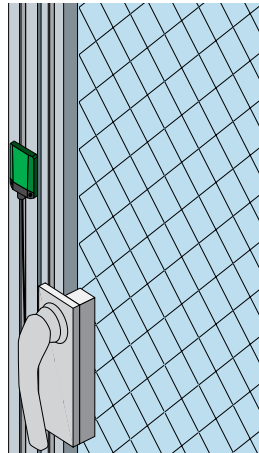

Robotic Arm

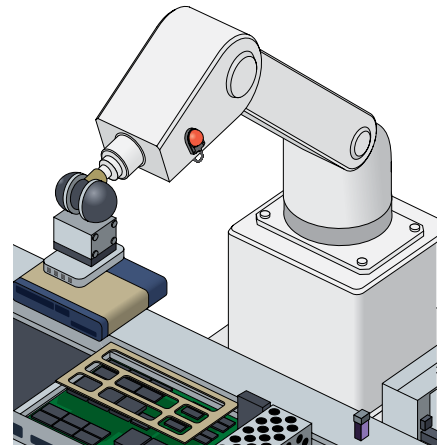

800-262-IDEC

www.IDEC.com/usa/SpiderLights



www.idec.com

USA
IDEC Corporation
Tel: (408) 747-0550
opencontact@IDEC.com

Canada
IDEC Canada Ltd.
Tel: (905) 890-8561
sales@ca.IDEC.com

Australia
IDEC Australia Pty. Ltd.
Tel: +61-3-9763-3244
sales@au.IDEC.com

Japan
IDEC Corporation
Tel: +81-6-6398-2571
products@IDEC.co.jp

United Kingdom
IDEC Electronics Ltd.
Tel: +44-1256-321000
IDEC@uk.IDEC.com

Germany
IDEC Elektrotechnik GmbH
Tel: +49-40-253054-0
service@IDEC.de

Hong Kong
IDEC (H.K.) Co., Ltd.
Tel: +852-2803-8989
info@hk.IDEC.com

China/Beijing
IDEC (Beijing) Corporation
Tel: +86-10-6581-6131
idec@cn.IDEC.com

China/Shanghai
IDEC (Shanghai) Corporation
Tel: +86-21-5353-1000
idec@cn.IDEC.com

China/Shenzhen
IDEC (Shenzhen) Corporation
Tel: +86-755-8356-2977

Singapore
IDEC Asia Pte. Ltd.
Tel: +65-6746-1155
info@sg.IDEC.com

Taiwan
IDEC Taiwan Corporation
Tel: +886-2-2698-3929
service@tw.IDEC.com

©2009 IDEC Corporation. All Rights Reserved.
Catalog No. LH9Y-B100-0 5/09 15K

Specifications and other descriptions in this catalog are subject to change without notice.