

# Dot Graphic VFD Module

# GU160x32F-7806A

- q 160x32 Dot Graphic (2/3/4 x 20+ characters)
- q Single 5V Supply
- q High Brightness Blue Green Display
- q Operating Temp -40°C to +85°C
- q 6 Multi Sized Fonts (Katakana / International)
- q 4/8 Bit Parallel LCD & Serial Interfaces

The module includes the Vacuum Fluorescent Display glass, VF drivers and micro-controller ICs with refresh RAM, character generator and interface logic. The 4/8 bit parallel & serial bi-directional interfaces are 5V TTL/CMOS compatible. The command set is LCD compatible with extended graphic functions.

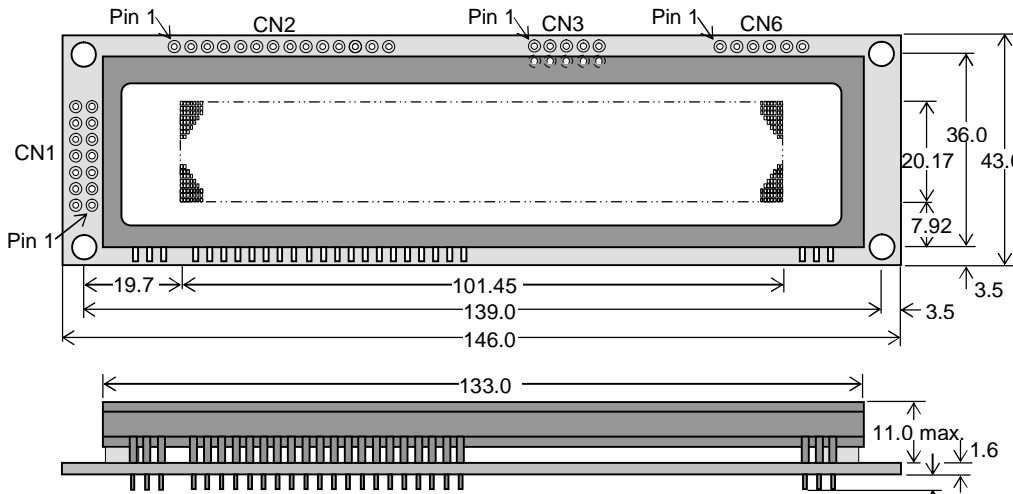

Dimensions in mm & subject to tolerances. Mounting holes 3.2mm dia.

### CN3 – SERIAL INTERFACE

Pin	Async	SPI
1	VCC	VCC
2	NC	SCK
3	RXD	/SS
4	LINK1	SIN
5	GND	GND
6	LINK2	SOUT
7	TXD	NC
8	/RES	/RES
9	MB	MB
10	HB	HB

NC = Do Not Connect

### CN1/2 - PARALLEL INTERFACE

Pin	Sig	Pin	Sig
1	GND	2	VCC
3	NC*	4	RS
5	R/W	6	E
7	D0	8	D1
9	D2	10	D3
11	D4	12	D5
13	D6	14	D7

Pin 3 can be changed to /RESET or BUSY terminal and selectable by jumper J3 (2-3) or J3 (1-2)

### ELECTRICAL SPECIFICATION

Parameter	Symbol	Value	Condition
Power Supply Voltage	VCC	5.0VDC +/- 5%	GND=0V
Power Supply Current	ICC	300mA typ.	VCC=5V
Logic High Input	VIH	0.8xVCC min. VCC max.	VCC=5V
Logic Low Input	VIL	0VDC min 0.6VDC max.	VCC=5V
Logic High Output	VOH	3.5VDC min. VCC max.	IOH=-10uA
Logic Low Output	VOL	0VDC min 0.6VDC max.	IOL=4mA

### OPTICAL and ENVIRONMENTAL SPECIFICATIONS

Parameter	Value
Display Area (XxY mm)	101.45 x 20.17
Dot Size/Pitch (XxY mm)	0.485 x 0.485 / 0.635 x 0.635
Luminance	500 cd/m <sup>2</sup> Typ.
Colour of Illumination	Blue-Green (Filter for colours)
Operating Temperature	-40°C to +85°C
Storage Temperature	-40°C to +85°C
Operating Humidity (non condensing)	20 to 80% RH @ 25°C

### SOFTWARE COMMAND SUMMARY

Instruction	R/W	RS	D0-D7
Clear Display	L	L	01H
Cursor Return Home	L	L	02H
Entry Mode Set	L	L	04H-07H
Display ON/OFF	L	L	08H-0FH
Cursor Shift Left	L	L	10H
Cursor Shift Right	L	L	14H
Display Shift Left	L	L	18H
Display Shift Right	L	L	1CH
Select 4/8 bit interface	L	L	20H (4Bit) / 30H (8Bit) + luminance
Display Luminance	L	H	00H - 03H (must follow above command)
Set CG RAM Addr.	L	L	40H-7FH
Set DD RAM Addr.	L	L	80H-E7H
Read BUSY/Addr.	H	L	00H-FFH D7 Busy = High
Read Data from RAM	H	H	00H-FFH
Set Graphic Cursor	L	L	F0H + <i>xpos</i> + <i>ypos</i>
Set Area Commands	L	L	F1H + <i>x1</i> + <i>y1</i> + <i>x2</i> + <i>y2</i> + <i>cmd</i> where <i>cmd</i> 49H = Invert Area 46H = Fill Area 43H = Clear Area 4FH = Set Outline Box 6FH = Clear Outline Box
Write Graphic Image	L	L	F1H + <i>x1</i> + <i>y1</i> + <i>x2</i> + <i>y2</i> + <i>cmd</i> + <i>data</i>
Set Font / Spacing / Line	L	L	F2H + <i>font style</i> / <i>line set</i>
User Expansion Ports	L	L	F4H-F8H Set, write and read user ports
Set RS Low			0FH Serial Comms. only
Read Data			FEH Serial Comms. only
Read Cursor Position			FFH Serial Comms. only

### CHARACTER SET

Standard Fonts	LCD Katakana Font	International Font
00 UDF1	! " # \$ % & ' ( ) * + , - . /	0 1 2 3 4 5 6 7 8 9 A B C D E F G
01 UDF2	: ; < = > ? @ A B C D E F G H I J K L M N O P Q R S T U V W X Y Z [ \ ] ^ _ ` {   } ~	! " # \$ % & ' ( ) * + , - . /
02 UDF3	0 1 2 3 4 5 6 7 8 9 A B C D E F G H I J K L M N O P Q R S T U V W X Y Z [ \ ] ^ _ ` {   } ~	! " # \$ % & ' ( ) * + , - . /
03 UDF4	! " # \$ % & ' ( ) * + , - . /	0 1 2 3 4 5 6 7 8 9 A B C D E F G
04 UDF5	: ; < = > ? @ A B C D E F G H I J K L M N O P Q R S T U V W X Y Z [ \ ] ^ _ ` {   } ~	! " # \$ % & ' ( ) * + , - . /
05 UDF6	! " # \$ % & ' ( ) * + , - . /	0 1 2 3 4 5 6 7 8 9 A B C D E F G
06 UDF7	: ; < = > ? @ A B C D E F G H I J K L M N O P Q R S T U V W X Y Z [ \ ] ^ _ ` {   } ~	! " # \$ % & ' ( ) * + , - . /
07 UDF8	! " # \$ % & ' ( ) * + , - . /	0 1 2 3 4 5 6 7 8 9 A B C D E F G
08 UDF1	: ; < = > ? @ A B C D E F G H I J K L M N O P Q R S T U V W X Y Z [ \ ] ^ _ ` {   } ~	! " # \$ % & ' ( ) * + , - . /
09 UDF2	! " # \$ % & ' ( ) * + , - . /	0 1 2 3 4 5 6 7 8 9 A B C D E F G
0A UDF3	: ; < = > ? @ A B C D E F G H I J K L M N O P Q R S T U V W X Y Z [ \ ] ^ _ ` {   } ~	! " # \$ % & ' ( ) * + , - . /
0B UDF4	! " # \$ % & ' ( ) * + , - . /	0 1 2 3 4 5 6 7 8 9 A B C D E F G
0C UDF5	: ; < = > ? @ A B C D E F G H I J K L M N O P Q R S T U V W X Y Z [ \ ] ^ _ ` {   } ~	! " # \$ % & ' ( ) * + , - . /
0D UDF6	! " # \$ % & ' ( ) * + , - . /	0 1 2 3 4 5 6 7 8 9 A B C D E F G
0E UDF7	: ; < = > ? @ A B C D E F G H I J K L M N O P Q R S T U V W X Y Z [ \ ] ^ _ ` {   } ~	! " # \$ % & ' ( ) * + , - . /
0F UDF8	! " # \$ % & ' ( ) * + , - . /	0 1 2 3 4 5 6 7 8 9 A B C D E F G

NOTE: UDF characters are available using 7x7 font only.

### Proportional Mini Font

00	01	02	03	04	05	06	07	08	09	0A	0B	0C	0D	0E	0F
!	"	#	\$	%	&	'	(	)	*	+	,	-	.	/	
0	1	2	3	4	5	6	7	8	9	A	B	C	D	E	F
G	H	I	J	K	L	M	N	O	P	Q	R	S	T	U	V
W	X	Y	Z	[	\	]	^	_	`	{		}	~		

### Serial / Parallel Selection

J6	Interface
Open	Sync Serial / Parallel (default)
Link	Asynchronous Serial

### Parallel Interface type (M68 / i80)

J2	J4	Mode	Signals
1-2	1-2	i80	Pin 5 = /WR, Pin 6 = /RD
2-3	2-3	M68	Pin 5 = R/W, Pin 6 = E

### SERIAL MODE

J12	Configuration
3-4	1-2 7-8
O	O O 9600, N, 8, 1
L	O O 19200, N, 8, 1
O	L O 38400, N, 8, 1
X	X L Self Test Mode

Copyright 2008 Noritake Itron Corp. Japan

### CN1 Pin 3 Function

J3	Font
2 & 3	/ Reset
1 & 2	Busy

All J12 links & J6 should be open for parallel operation.

### CONTACT

**Noritake Sales Office Tel Nos**  
 Nagoya Japan: +81 (0)52-561-9867  
 Canada: +1-416-291-2946  
 Chicago USA: +1-847-439-9020  
 Munchen (D): +49 (0)89-3214-290  
 Itron UK: +44 (0)1493 601144  
 Rest Europe: +49 (0)61-0520-9220  
[www.noritake-iron.com](http://www.noritake-iron.com)

Subject to change without notice.  
 IUK Doc Ref: 32586 Iss:1 14 Aug 08

## SOFTWARE COMMANDS

Instruction	Data Format (RS = 1)	Description
UDF Write	00H – 0FH	Write user defined character 1-8 to the current cursor location on the display.
Data Write (40us – LCD compatible mode) (250us – Graphic mode)	00H – FFH	Write data to the display. In normal (LCD compatible) mode of operation, data is written to the display data (DD RAM) or character generator (CG RAM). When using the graphical data commands (F0H, F1H & F2H), data is written direct to the display and is not stored in DD RAM. Data write busy times will increase when using the graphic functions.
Data Read (40us – LCD compatible mode)	00H – FFH	Read data from the display. In normal (LCD compatible) mode of operation, data is read from the display data (DD RAM) or character generator (CG RAM).
Instruction	Data Format (RS = 0)	Description
Status / Cursor Position Read (40us – LCD compatible mode)	00H - FFH	D0 – D6 of read data corresponds to the current cursor position. D7 shows the status of busy.
Display Clear (150us)	01H	Fills all locations in the display data (DD) RAM with 20H (blank character). The address counter is set to 0 in the DD RAM. The address counter is set to increment on each data read/write. Any display offset (using the display shift command) is removed.
Cursor Home (500us)	02H	The address counter is set to 0 in the DD RAM. Any display offset (using the display shift command) is removed.
Entry Mode (40us)	04H – 07H	Bit 1 is used to select the direction of the address counter on each data read or write. If set to '1', the address counter is incremented. If set to '0', the address counter is decremented. Bit 0 enables the display to shift on each data read/write. If this bit is set to '1', the display is shifted with the cursor. The display shift direction depends upon the address counter direction (bit1). If this is set to increment, the display is shifted left, if the address counter is set to decrement, the display is shifted right. Note: When display shift is enabled, the data write busy time can increase by 200us.
Display Control (50us)	08H-0FH	Bit 2 is used to enable or disable the display. If this bit is set to '0' the VFD's power supply is turned off to reduce power consumption. Bit 0 enables the flashing block cursor. Note: If the cursor is enabled, busy times can increase by 20us.
Cursor Shift Left (40us)	10H	Shift the cursor position (address counter) one position to the left.
Cursor Shift Right (40us)	14H	Shift the cursor position (address counter) one position to the right.
Display Shift Left (150us)	18H	Shift the display left, one character position.
Display Shift Right (150us)	1CH	Shift the display right, one character position.
Select 4 bit interface (40us)	20H + lum (RS=1)	Enables 4-bit communications. Data is received on DB4-DB7 only. Two writes are required to send one data byte. The most significant nibble should be sent first. Refer to the 'Parallel Communications' section for more information. The lum value sets the displays brightness, and must be sent with the RS line high: - 00H = full brightness, 01H = 75%, 02H = 50% & 03H = 25%.
Select 8 bit interface (40us)	30H + lum (RS=1)	Enables 8-bit communications. Data is received on DB0-DB7. The lum value sets the displays brightness, and must be sent with the RS line high: - 00H = full brightness, 01H = 75%, 02H = 50% & 03H = 25%.
Set CG Address (40us)	40H – 7FH	Set the character generator address (CG RAM). All written data is placed within the user definable character area.
Set DD Address (40us)	80H – E7H	Set the display data address (DD RAM). 80H - 93H = 1st line. C0H – D3H = 2nd line. 94H – A7H = 3rd line. D4H – E7H = 4th line
Set Graphic Cursor <sup>*Note</sup> (40us)	F0H + xpos + ypos	Set the absolute cursor position. xpos = 0 – 159, ypos = 0 – 47. Co-ordinates should be written with RS line set high.
Set Area <sup>*Note</sup> (40us + 500us(cmd byte))	F1H + x1 + y1 + x2 + y2 + cmd	Area Commands: - 'I' - invert area, 'F' – fill area, 'C' = clear area, 'O' – set outline, 'o' – clear outline. All area commands should be preceded with the area co-ordinates. X1 Y1 left top X2 Y2 bottom right. Co-ordinates, command and graphical data should be written with RS line set high.
Write Graphic Image	F1H + x1 + y1 + x2 + y2 + cmd	Image Commands: - 'H' – write horizontal graphical data with horizontal cursor movement. 'V' – write vertical graphical data with horizontal cursor movement. 'h' – write horizontal graphical data with vertical cursor movement. 'v' – write vertical graphical data with vertical cursor movement. Graphical data should immediately follow the 'H', 'h', 'V' and 'v' commands. Co-ordinates, command and graphical data should be written with RS line set high.
Set Font / Lines <sup>*Note</sup> (40us)	F2H + font / line number	Select font type, font size and font spacing. Select number of lines to display in LCD emulation mode. Font commands: 'A' or 'a' = 64 character mini-font. 'B' = 5x7 font with Katakana. 'b' = 5x7 font with International. 'C' = 10x14 font with Katakana. 'c' = 10x14 font with International. 'D' = 7x7 LCD font with Katakana. 'd' = 7x7 LCD font with International. 'E' = 7x15 font with Katakana. 'e' = 7x15 font with International. 'F' and 'f' = 20x28 font using pixel doubling of 'C' and 'c'. Font spacing: 'P' = Proportional, 'M' = Mono-spaced, '1' or '2' = 1 / 2 pixel inter-character spacing Display Lines: 'L' = 2 Lines with 7x7 fonts, '3' = 3 Lines with 7x7 fonts, '4' = 4 Lines with 7x7 fonts. Font / line commands should be written with RS line set high.
Port Configure	F4H + byte	Bit 7 High = I/O Port, Low = Serial Port. See extended port and serial commands.
Read Port Status	F5H	The current port status is read with RS high. See extended port and serial commands.
Port Out / Serial Send	F6H + byte	byte is output from the port. In serial mode check the busy status before sending again.
Port In / Serial Read	F7H	The current port levels or buffered received data can be read with RS high.
Port Buffer Send	F8H + size + data	Up to 128 bytes of data can be buffered before being transmitted from the serial port.
Instruction	Data Format	Additional Serial Data Commands
Set RS Low	0FH	Set the RS line low for the following byte only. Used in serial communications only.
Read Data	FEH	Read data at current cursor position. This command is used with serial communications only.
Read Cursor Position	FFH	Read current cursor position. This command is used with serial communications only.

**Note:** After these commands are executed, the cursor will be disabled and any character data will be written to the display only, and not the DD RAM. Any subsequent LCD compatible command will re-enable the cursor and allow for DD RAM writing.

## GRAPHICAL DATA WRITES

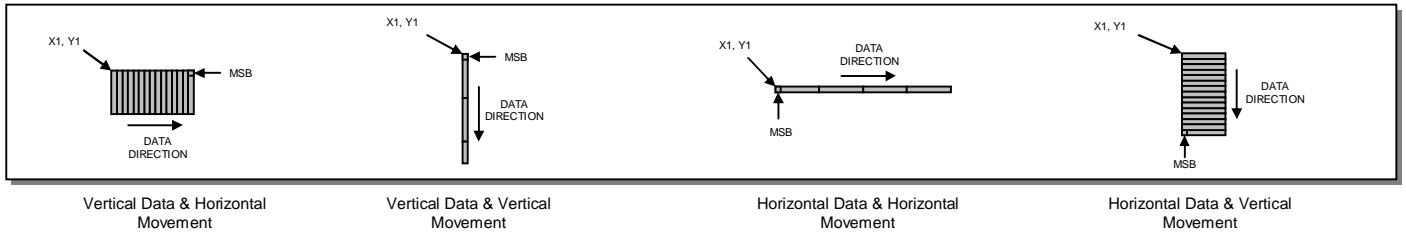

## PARALLEL COMMUNICATIONS

This module has a fast latching 8-bit data bus. The 'RS' and 'R/W' control lines should be set prior to the rising edge of the 'E' enable line. Data is clocked in on the falling edge of the enable line. The busy line should be checked before sending data.

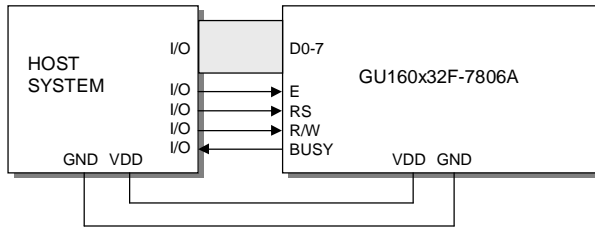

The busy state can be monitored on D7 when reading the DDRAM address (RS line low). The busy state can also be monitored directly from CN1 pin 3 if link J6 is set to 2&3.

### 8-Bit Data Write Timing Diagram.

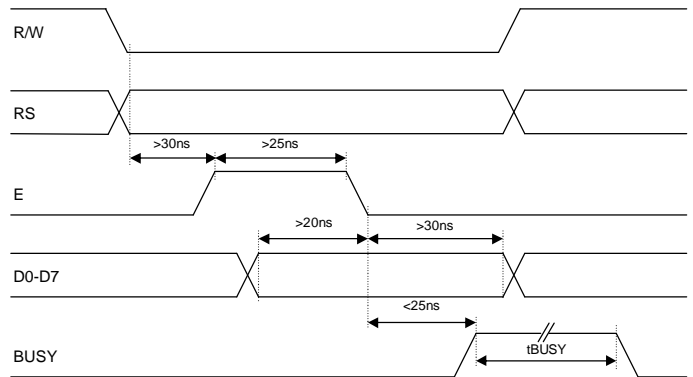

### 8-Bit Data Read Timing Diagram.

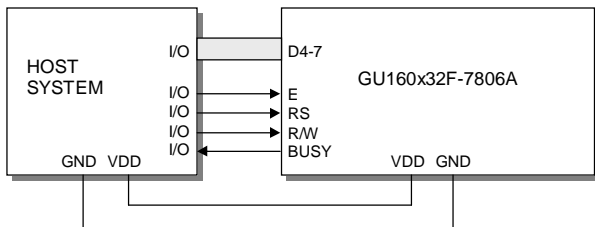
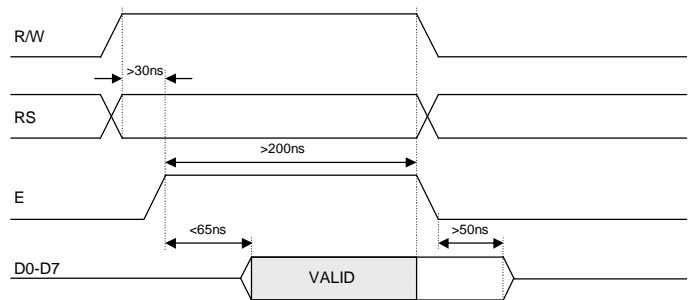

The data bus width can be selected for 4-bit operation, using data lines D4-D7. Within this mode, two writes are required to send one data byte. The high nibble (bits 4-7) should be sent first, followed by the low nibble (bits 0-3). The busy state is not triggered between nibbles. It is important that the status is NOT read within 40us of sending the command to set either 4 or 8 bit mode.

### 4-Bit Data/Command Write Timing Diagram.

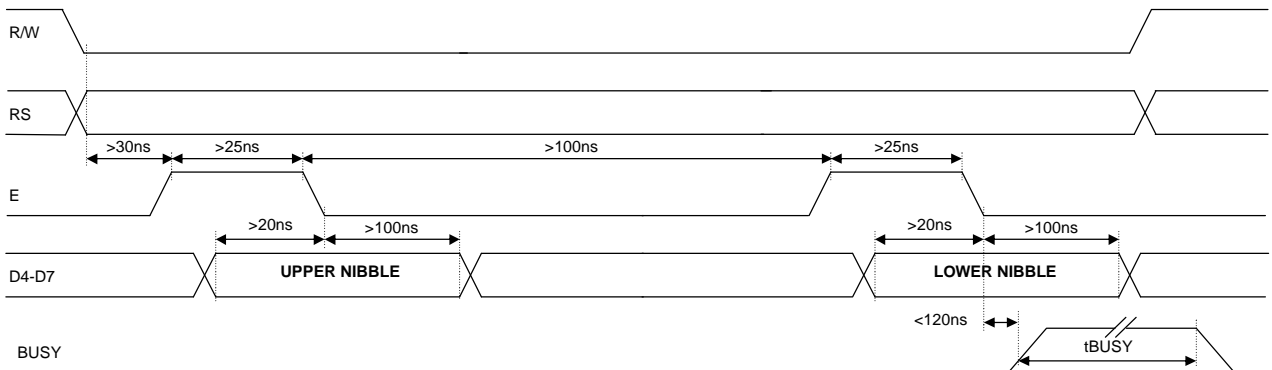

### 4-Bit Data/Status Read Timing Diagram.

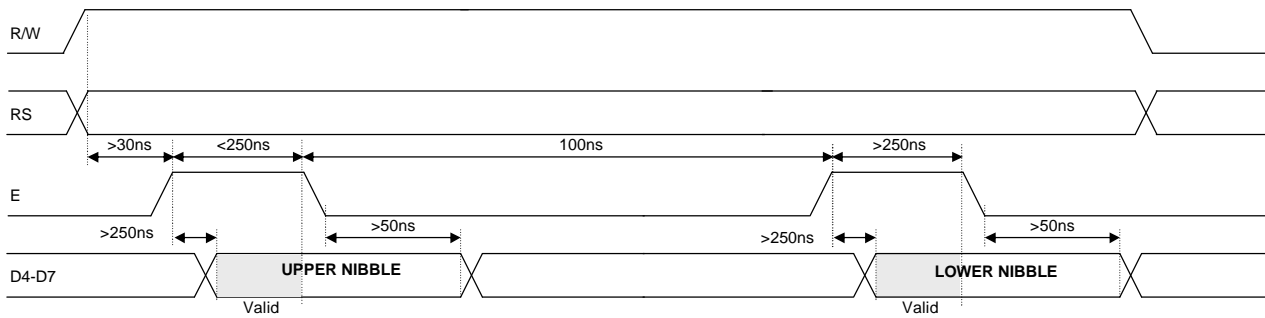

### ASYNCHRONOUS SERIAL COMMUNICATION

Asynchronous & synchronous serial interfaces are provided at TTL level. Synchronous is enabled with parallel, first received byte disables the other. To enable Asynchronous Serial Mode connect pin 4 and 6 on CN2 (LINK1 and LINK2), Link J6 and enable i80 Mode on J2 and J4. When using Asynchronous serial communications, the module is automatically initialized at power-up/reset with the cursor enabled.

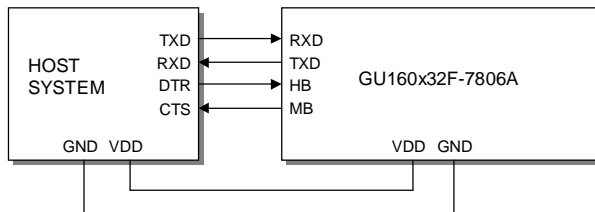

#### Host to Module Write

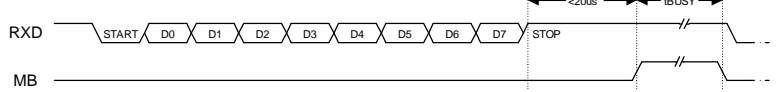

#### Module to Host Write

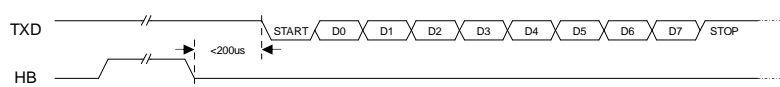

The host busy line (HB) stops the module from sending data to the host. The use of the HB and MB lines are optional, and can be connected together if not required.

### SYNCHRONOUS SERIAL COMMUNICATION

With synchronous communications enabled, data can be clocked into the VFD module on the rising edge of SCK, with the MSB sent first. The host must provide adequate delays for the module to process the data, these busy times are specified in the software command section. Alternatively the host can monitor the MB (Module Busy) line.

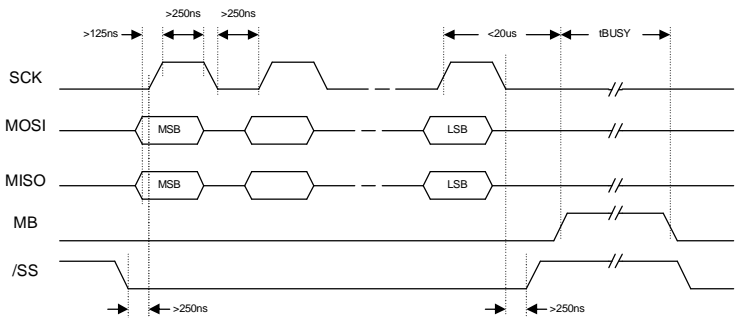
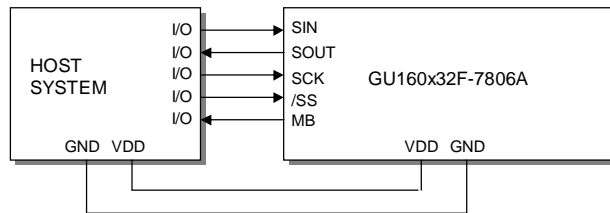

TTL Synchronous serial communication.

The /SS pin can be used as an enable pin if other devices are connected to the serial line, and also allows byte synchronisation. The use of the /SS line is recommended, but can be permanently pulled low if not required.

### SERIAL CONTROL

An additional command has been included to distinguish between command and data writes when using serial communications. This command (0FH) will temporarily set the RS line low for the subsequent written byte. The following example displays two text messages using the serial communications and the 'Set RS' command: -

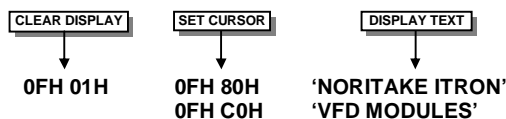

Displaying text using serial communications.

## LCD COMPATIBILITY

This module features a command set that is LCD compatible, allowing easy replacement in existing equipment with little or no modifications. Careful consideration should be taken regarding the command execution times of this module. Although the commands can be executed within 40µs, which is normal for LCD, busy times are increased when using the scroll write modes and with the cursor enabled. When using the 4-bit parallel mode, a 40µs delay is required between nibbles. Reading back data in 4-bit parallel mode is supported. DD RAM address locations F0H+ are used to access the extended graphic commands.

At power up and reset the module is automatically initialised and ready to receive data. The interface is set to 8-bit, the display is cleared, the cursor position is set to the top-left corner (DD RAM address = 00H), and the display luminance is set to 100%. The display defaults to 2-line LCD emulation mode with a 7x7 font.

## RESET

At power ON the modules internal reset requires at least 8ms before commands can be sent. Please check the busy status. If you connect pin 3 to the hardware reset using jumper 3, the module will require 3ms to re-initialize. Reset is achieved by high-low-high transition of at least 100ns.

## EXTENDED GRAPHIC COMMANDS

Command Structure and Values Copyright 2007 Noritake Co Limited, Japan

In addition to the standard LCD commands, this module includes additional commands to display graphical data, different font sizes, fill, clear and invert defined areas of the display. Also an outline command is available to draw rectangles around objects. When any of these extended commands are executed, the module will change to the 'graphics' mode of operation. This graphics mode allows text to be written to any part of the display.

There are many differences the user should be aware of when the display is in this graphics mode: -

- Written data may require additional busy times.
- Text data is not written into the DD RAM and therefore can not be read back.
- Graphical text can not be shifted onto the display.
- The cursor is disabled & cursor direction is set to increment only.
- UDF characters cannot be written.

The graphics mode is disabled as soon as any valid LCD command is received.

## DISPLAYING GRAPHICAL TEXT

The module contains 6 font sizes, a mini-font, 5x7 pixel, 7x7 pixel, 7x15 pixel, 10x14 pixel, and a 20x28 pixel font. Graphical text can be written to any part of the display using the 'Set Graphic Cursor' command (F0H). Characters are positioned above the current cursor position. Each character written will include either a one pixel or two pixel space to the right side of the character. After each character is written to the display, the cursor position is automatically advanced. If the cursor position reaches the end of the display, the host must reposition to the next line.

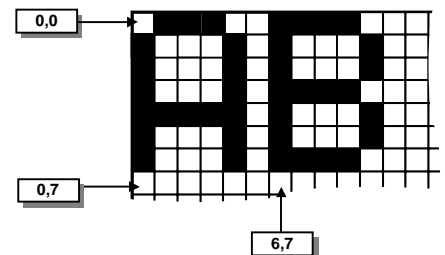

Cursor Positioning, example of writing 2 characters from cursor position 0,7.

The following example displays two text messages in the center of the display using the standard 5x7 character font. Command bytes that are underlined should be sent with RS line low.

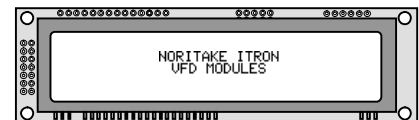
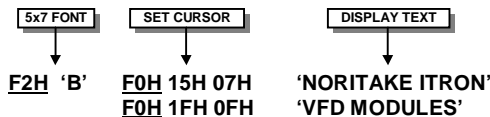

Displaying text using the 5x7 font.

The next example displays one line of text using the 10x14 character font. Command bytes that are underlined should be sent with RS line low.

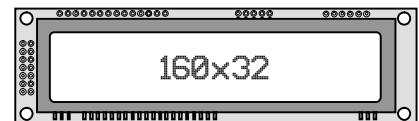
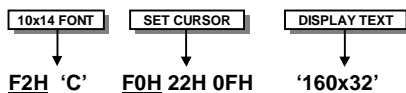

Displaying text in the large 10x14 font.

## DISPLAYING GRAPHICS

Graphical images can be displayed on the VFD module in either a horizontal or vertical byte orientation. After each graphical data write, the cursor is automatically advanced. All graphical data is contained within the defined area. Unused bits are masked where the screen area is not a byte multiple

The following example displays a simple graphical image. The graphical data orientation is set to horizontal data format, with a vertical cursor movement. Command bytes that are underlined should be sent with RS line low.

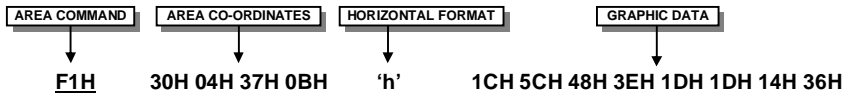

The next example displays a simple graphical image using a vertical data format, with a horizontal cursor movement. Command bytes that are underlined should be sent with RS line low.

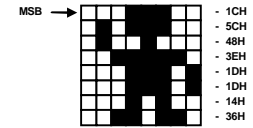
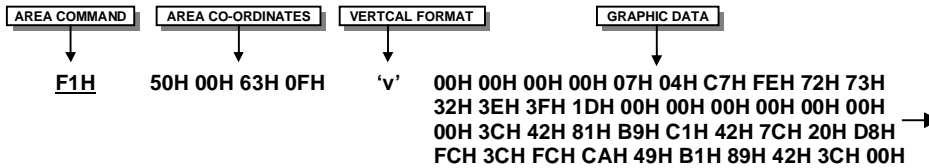

Graphic Image using horizontal data

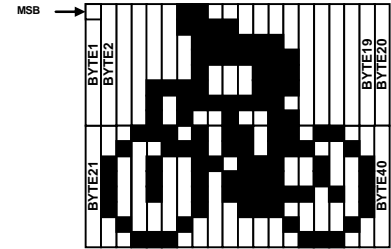

Graphic Image using vertical data

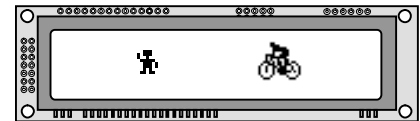

Displaying graphic images in vertical and horizontal format.

## AREA COMMANDS

The VFD module contains commands to fill, clear and invert defined areas of the display. Also an outline command is available to draw rectangles around objects.

The following example displays three options for the user to select, each option is contained within a box with a shadow effect. Drawing horizontal and vertical lines using the fill area command creates the shadow effect. Command bytes that are underlined should be sent with RS line low.

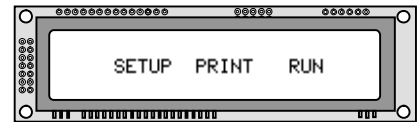
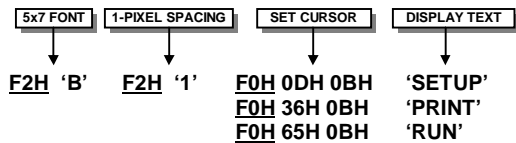

Display options with simple graphic text write.

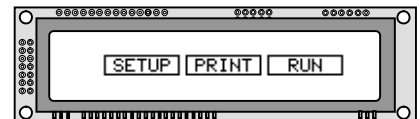
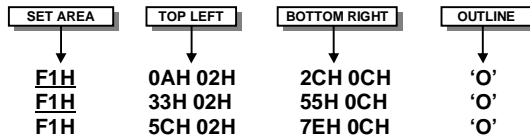

Boxes created using the 'Set Area Outline' command.

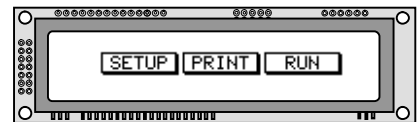
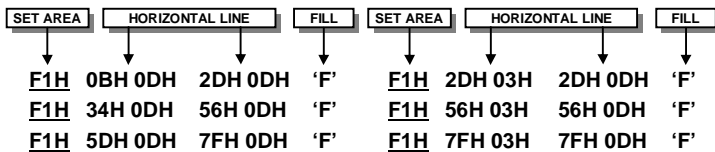

Drop Shadows created with the 'Fill Area' command.

The next example uses the invert area command to select one of the options.

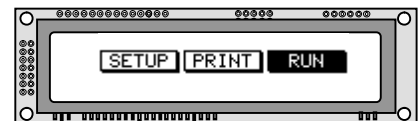
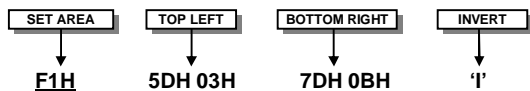

Option 'Run' selected with the 'Invert Area' command.

## EXTENDED PORT AND SERIAL COMMANDS

Command Structure and Values Copyright 2007 Noritake Co Limited, Japan

The extended port and serial commands are only valid when the display is connected to the host using the parallel interface.

### PORT I/O MODE

The I/O mode gives direct access to the 7 control lines on the serial connector; HB, MB, TXD, RXD, MISO, MOSI and SCK. Each line can be individual set to an Input or Output using the 'PORT CONFIGURE' command. All inputs include an optional pull-up resistor, 30K-120K in value. The outputs can source ~5mA and sink ~30mA. There are 3 commands available to configure port, set port level and read port state.

Example: -

- F4H 82H** - Set RXD to input and other ports to outputs.
- F6H 02H** - Turn on LED1&2 by setting HB & MB low. Enable internal pull-up resistor on RXD.
- F7H** - Read port, D1 is the switch state.

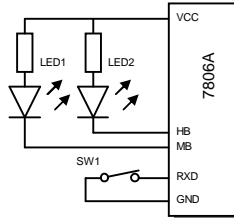

### SYNCHRONOUS SERIAL MODE

This mode gives the ability to control external synchronous devices connected to the serial connector. Data is transmitted and received on each 'PORT OUT' command. The received data byte is buffered until the 'PORT READ' command is executed.

The 'PORT BUFFER SEND' command will buffer up to 128 bytes of data prior to transmission; only the last data byte received is captured when using this command.

The 'PORT CONFIGURE' command will set the MOSI & SCK lines to outputs, and the MISO line to an input. The HB line is used as an optional busy input, and the MB line is set to an output. The TXD line is also set to an output, and this can be used as a reset or device select control line.

The serial transmission is defined by the 'DEF H/L' (default clock level high or low), 'CLK EDGE' (rising or falling clock edge), and the 'SPEED' (clock speed) control bits. The 'HNDSHK' bit is used to detect the status of the HB line prior to data transmit. All data is transmitted MSB first.

A 'STATUS READ' command can be used to check for completed data transmission.

Example: -

- F4H 1BH** - Enable Synchronous mode with busy test; clock speed to 125kHz, data clocked on falling edge, default clock level is low.
- F6H 55H** - Send byte 55H to synchronous port when HB line is low.
- F5H** - Read current status. Wait until TXC is set.
- F5H** - Read current status. Check if RXC is set.
- F7H** - Read received byte.
- F8H 16H** "This is a test string." - Send character string when HB line is low.
- F5H** - Read current status. Wait until TXC is set.

### PORT CONFIGURE

#### F4H + I/O

D7	D6	D5	D4	D3	D2	D1	D0
1	HB I/O	MB I/O	TXD I/O	MISO I/O	MOSI I/O	RXD I/O	SCK I/O

A '1' defines the port as an input, '0' an output. All ports are subsequently set low.

### PORT OUT

#### F6H + OUT

D7	D6	D5	D4	D3	D2	D1	D0
-	HB OUT	MB OUT	TXD OUT	MISO OUT	MOSI OUT	RXD OUT	SCK OUT

A '1' sets the corresponding port high, and a '0' sets it low. If the port is set to an input, a '1' will enable the internal pull-up resistor.

### PORT IN

#### F7H

D7	D6	D5	D4	D3	D2	D1	D0
-	HB IN	MB IN	TXD IN	MISO IN	MOSI IN	RXD IN	SCK IN

The current port levels are read with RS high.

### PORT CONFIGURE

#### F4H + SETUP

D7	D6	D5	D4	D3	D2	D1	D0
0	0	TXD OUT	HNDSHK	DEF HL	CLK EDGE	SPEED1	SPEED0

The TXD port is set high with a '1' and low with a '0'. Busy detection is enabled by setting HNDSHK to a '1'. The default clock level is high with DEF H/L set to a '1', low if '0'. The CLK EDGE is set to rising with a '1', and falling with a '0'. The clock speed is set with the SPEED1/0 bits, 00=4Mhz, 01=1Mhz, 10=250kHz, 11=125kHz.

### SERIAL SEND

#### F6H + DATA

Data is transmitted to the synchronous serial port. If the 'HNDSHK' bit is enabled, transmission will be delayed until the HB line is pulled low.

### PORT BUFFER SEND

#### F8H + SIZE + DATA

A maximum of 128-bytes of data is buffered before transmission to the synchronous serial port. If the 'HNDSHK' bit is enabled, transmission is delayed until HB line is low.

### READ PORT STATUS

#### F5H

D7	D6	D5	D4	D3	D2	D1	D0
-	-	-	HB IN	TX PEND	TXC	RXC	-

The current port status is read with RS high. TX PEND shows data is pending for transmission, TXC transmission completed, and RXC shows data received. HB IN shows the current state of the 'HB' line. TXC is cleared after status read.

### SERIAL READ

#### F7H

The currently buffered data byte can be read with RS high. The host should first check the RXC bit using the PORT STATUS command. After reading the data byte, the RXC bit is cleared.

## ASYNCHRONOUS SERIAL MODE

This mode gives the ability to control external asynchronous devices connected to serial connector. Data is transmitted on each 'PORT OUT' command. Data received is held within a 1 byte buffer until the 'PORT READ' command is executed.

The 'PORT BUFFER SEND' command will buffer up to 128 bytes of data prior to transmission.

The 'PORT CONFIGURE' command will set the TXD & MB lines to outputs, and the RXD line to an input. The MISO line is also set to an output, and this can be used as a reset or device select control line. The HB line is used as an optional busy input. The MB line mirrors the RXC status flag, and indicates that data has been received.

A 'STATUS READ' command can be used to check for completed data transmission.

Data Write Example: -

- F4H 5AH** - Enable Asynchronous mode with busy test; set interface to 19200E.
- F6H 55H** - Send byte 55H to asynchronous port when HB line is low.
- F5H** - Read current status. Wait until TXC is set.
- F6H AAH** - Send byte AAH to asynchronous port when HB line is low.

- F8H 16H "This is a test string."** - Send character string when HB line is low.
- F5H** - Read current status. Wait until TXC is set.

Data Read Example: -

- F5H** - Read current status. Repeat until RXC is set.
- F7H** - Read received byte.

## PORT CONFIGURE

## F4H + SETUP

D7	D6	D5	D4	D3	D2	D1	D0
0	1	MISO OUT	HNDSHK	PARITY1	PARITY0	BAUD1	BAUD0

The MISO port is set high with a '1' and low with a '0'. Busy detection is enabled by setting HNDSHK to a '1'. The parity is set with the PARITY1/0 bits, 00=none, 10=even & 11=odd. The baud rate is set with the BAUD1/0 bits, 00=4800, 01=9600, 10=19200 & 11=38400.

## SERIAL SEND

## F6H + DATA

Data is transmitted to the asynchronous serial port. If the 'HNDSHK' bit is enabled, transmission will be delayed until the HB line is pulled low.

## PORT BUFFER SEND

## F8H + SIZE + DATA

A maximum of 128-bytes of data is buffered before transmission to the asynchronous serial port. If the 'HNDSHK' bit is enabled, transmission is delayed until HB line is low.

## READ PORT STATUS

## F5H

D7	D6	D5	D4	D3	D2	D1	D0
-	-	-	HB IN	TX PEND	TXC	RXC	RX ERR

The current port status is read with RS high. TX PEND shows that data is pending for transmission, TXC transmission was completed, and RXC shows data has been received. RX ERR indicates a received parity, overrun or framing error. HB IN shows the current state of the 'HB' line. The TXC bit is cleared after status read.

## SERIAL READ

## F7H

The currently buffered data byte can be read with RS high. The host should first check the RXC bit using the PORT STATUS command. After reading the data byte, the RXC bit is cleared.



### 5x5 Mini Font

	00	01	02	03	04	05	06	07	08	09	0A	0B	0C	0D	0E	0F
20	!	l	H	b	z	5	C	)	*	+	.	-	.	/		
30	0	1	2	3	4	5	6	7	8	9	:	:	<	=	>	?
40	0	A	B	C	D	E	F	G	H	I	J	K	L	M	N	O
50	P	Q	R	S	T	U	V	W	X	Y	Z	[	¥	]	^	_

### 5x7 Font - Main

	00	01	02	03	04	05	06	07	08	09	0A	0B	0C	0D	0E	0F
00	UDF	UDF	UDF	UDF	UDF	UDF	UDF	UDF	UDF	UDF	UDF	UDF	UDF	UDF	UDF	UDF
10	!	l	H	b	z	5	C	)	*	+	.	-	.	/		
20	!	"	#	\$	%	&	'	(	)	*	+	.	-	.	/	
30	0	1	2	3	4	5	6	7	8	9	:	:	<	=	>	?
40	0	A	B	C	D	E	F	G	H	I	J	K	L	M	N	O
50	P	Q	R	S	T	U	V	W	X	Y	Z	[	¥	]	^	_
60	`	a	b	c	d	e	f	g	h	i	j	k	l	m	n	o
70	P	q	r	s	t	u	v	w	x	y	z	(		)	→	←

### 5x7 Font - Katakana

	00	01	02	03	04	05	06	07	08	09	0A	0B	0C	0D	0E	0F
80	ä	ä	ä	ä	E	ö	ö	ö	ö	ü	ü	\	#	~	§	
90	æ	æ	æ	æ	o	o	o	o	o	o	o	o	o	o	o	o
A0	g	g	g	g	h	h	h	h	h	h	h	h	h	h	h	h
B0	—	ア	イ	ウ	エ	オ	カ	キ	ク	ケ	コ	サ	シ	ス	セ	ソ
C0	チ	ツ	テ	ト	ナ	ニ	ヌ	ネ	ノ	ヘ	フ	ハ	ホ	フ	フ	フ
D0	ミ	ム	メ	モ	リ	ロ	ル	レ	ロ	ワ	ヰ	ヱ	ヰ	ヱ	ヰ	ヱ
E0	α	ä	β	ε	μ	σ	ρ	g	γ	ι	j	*	ε	±	ñ	ö
F0	p	q	θ	∞	Ω	Ü	Σ	π	α	γ	¥	¥	¥	÷		■

### 5x7 Font - International

	00	01	02	03	04	05	06	07	08	09	0A	0B	0C	0D	0E	0F
80	É	é	í	l	Ł	ł	ó	é	h	θ	λ	π	τ	φ	ω	
90	Σ	Ω	Ξ	Χ	÷	ο	ϕ	Ε	∠	∆	#	Γ	θ	ι	ο	⊗
A0	ı	ı	ı	ı	ı	ı	ı	ı	ı	ı	ı	ı	ı	ı	ı	ı
B0	#	±	²	³	´	µ	¶	.	.	¹	º	»	¼	½	■	¿
C0	À	Á	Â	Ã	Ä	Å	Æ	Ç	È	É	Ê	Ë	Ì	Í	Î	Ï
D0	Ð	Ñ	Ò	Ó	Ô	Õ	Ö	×	Ø	Ù	Ú	Û	Ü	Ý	Þ	ß
E0	à	á	â	ã	ä	å	æ	ç	è	é	ê	ë	ì	í	î	ï
F0	ð	ñ	ò	ó	ô	õ	ö	÷	ø	ù	ú	û	ü	ý	þ	ÿ

### 10x14 Font - Main

	00	01	02	03	04	05	06	07	08	09	0A	0B	0C	0D	0E	0F
10	!	l	H	b	z	5	C	)	*	+	.	-	.	/		
20	!	"	#	\$	%	&	'	(	)	*	+	.	-	.	/	
30	0	1	2	3	4	5	6	7	8	9	:	:	<	=	>	?
40	0	A	B	C	D	E	F	G	H	I	J	K	L	M	N	O
50	P	Q	R	S	T	U	V	W	X	Y	Z	[	¥	]	^	_
60	`	a	b	c	d	e	f	g	h	i	j	k	l	m	n	o
70	P	q	r	s	t	u	v	w	x	y	z	(		)	→	←

### 10x14 Font - Katakana

	00	01	02	03	04	05	06	07	08	09	0A	0B	0C	0D	0E	0F
80	ä	ä	ä	ä	E	ö	ö	ö	ö	ü	ü	\	#	~	§	
90	æ	æ	æ	æ	o	o	o	o	o	o	o	o	o	o	o	o
A0	g	g	g	g	h	h	h	h	h	h	h	h	h	h	h	h
B0	—	ア	イ	ウ	エ	オ	カ	キ	ク	ケ	コ	サ	シ	ス	セ	ソ
C0	チ	ツ	テ	ト	ナ	ニ	ヌ	ネ	ノ	ヘ	フ	ハ	ホ	フ	フ	フ
D0	ミ	ム	メ	モ	リ	ロ	ル	レ	ロ	ワ	ヰ	ヱ	ヰ	ヱ	ヰ	ヱ
E0	α	ä	β	ε	μ	σ	ρ	g	γ	ι	j	*	ε	±	ñ	ö
F0	p	q	θ	∞	Ω	Ü	Σ	π	α	γ	¥	¥	¥	÷		■

### 10x14 Font - International

	00	01	02	03	04	05	06	07	08	09	0A	0B	0C	0D	0E	0F
80	É	é	í	l	Ł	ł	ó	é	h	θ	λ	π	τ	φ	ω	
90	Σ	Ω	Ξ	Χ	÷	ο	ϕ	Ε	∠	∆	#	Γ	θ	ι	ο	⊗
A0	ı	ı	ı	ı	ı	ı	ı	ı	ı	ı	ı	ı	ı	ı	ı	ı
B0	#	±	²	³	´	µ	¶	.	.	¹	º	»	¼	½	■	¿
C0	À	Á	Â	Ã	Ä	Å	Æ	Ç	È	É	Ê	Ë	Ì	Í	Î	Ï
D0	Ð	Ñ	Ò	Ó	Ô	Õ	Ö	×	Ø	Ù	Ú	Û	Ü	Ý	Þ	ß
E0	à	á	â	ã	ä	å	æ	ç	è	é	ê	ë	ì	í	î	ï
F0	ð	ñ	ò	ó	ô	õ	ö	÷	ø	ù	ú	û	ü	ý	þ	ÿ

7x7 LCD Font - Main

	00	01	02	03	04	05	06	07	08	09	0A	0B	0C	0D	0E	0F
10																
20	!	"	#	\$	%	&	'	(	)	*	+	,	-	.	/	
30	0	1	2	3	4	5	6	7	8	9	:	;	<	=	>	?
40	@	A	B	C	D	E	F	G	H	I	J	K	L	M	N	O
50	P	Q	R	S	T	U	V	W	X	Y	Z	[	¥	]	^	_
60	`	a	b	c	d	e	f	g	h	i	j	k	l	m	n	o
70	p	q	r	s	t	u	v	w	x	y	z	{		}	←	→

7x7 LCD Font - Katakana

	00	01	02	03	04	05	06	07	08	09	0A	0B	0C	0D	0E	0F
80	ā	ā	ā	ā	ā	ā	ā	ā	ā	ā	ā	ā	ā	ā	ā	ā
90	ē	ē	ē	ē	ē	ē	ē	ē	ē	ē	ē	ē	ē	ē	ē	ē
A0	ī	ī	ī	ī	ī	ī	ī	ī	ī	ī	ī	ī	ī	ī	ī	ī
B0	ō	ō	ō	ō	ō	ō	ō	ō	ō	ō	ō	ō	ō	ō	ō	ō
C0	ū	ū	ū	ū	ū	ū	ū	ū	ū	ū	ū	ū	ū	ū	ū	ū
D0	ē	ē	ē	ē	ē	ē	ē	ē	ē	ē	ē	ē	ē	ē	ē	ē
E0	ī	ī	ī	ī	ī	ī	ī	ī	ī	ī	ī	ī	ī	ī	ī	ī
F0	ō	ō	ō	ō	ō	ō	ō	ō	ō	ō	ō	ō	ō	ō	ō	ō

7x7 LCD Font - International

	00	01	02	03	04	05	06	07	08	09	0A	0B	0C	0D	0E	0F
80	ē	ē	ē	ē	ē	ē	ē	ē	ē	ē	ē	ē	ē	ē	ē	ē
90	ī	ī	ī	ī	ī	ī	ī	ī	ī	ī	ī	ī	ī	ī	ī	ī
A0	ō	ō	ō	ō	ō	ō	ō	ō	ō	ō	ō	ō	ō	ō	ō	ō
B0	ū	ū	ū	ū	ū	ū	ū	ū	ū	ū	ū	ū	ū	ū	ū	ū
C0	ē	ē	ē	ē	ē	ē	ē	ē	ē	ē	ē	ē	ē	ē	ē	ē
D0	ī	ī	ī	ī	ī	ī	ī	ī	ī	ī	ī	ī	ī	ī	ī	ī
E0	ō	ō	ō	ō	ō	ō	ō	ō	ō	ō	ō	ō	ō	ō	ō	ō
F0	ū	ū	ū	ū	ū	ū	ū	ū	ū	ū	ū	ū	ū	ū	ū	ū

7x15 Font - Main

	00	01	02	03	04	05	06	07	08	09	0A	0B	0C	0D	0E	0F
10																
20	!	"	#	\$	%	&	'	(	)	*	+	,	-	.	/	
30	0	1	2	3	4	5	6	7	8	9	:	;	<	=	>	?
40	@	A	B	C	D	E	F	G	H	I	J	K	L	M	N	O
50	P	Q	R	S	T	U	V	W	X	Y	Z	[	¥	]	^	_
60	`	a	b	c	d	e	f	g	h	i	j	k	l	m	n	o
70	p	q	r	s	t	u	v	w	x	y	z	{		}	←	→

7x15 Font - Katakana

	00	01	02	03	04	05	06	07	08	09	0A	0B	0C	0D	0E	0F
80	ā	ā	ā	ā	ā	ā	ā	ā	ā	ā	ā	ā	ā	ā	ā	ā
90	ē	ē	ē	ē	ē	ē	ē	ē	ē	ē	ē	ē	ē	ē	ē	ē
A0	ī	ī	ī	ī	ī	ī	ī	ī	ī	ī	ī	ī	ī	ī	ī	ī
B0	ō	ō	ō	ō	ō	ō	ō	ō	ō	ō	ō	ō	ō	ō	ō	ō
C0	ū	ū	ū	ū	ū	ū	ū	ū	ū	ū	ū	ū	ū	ū	ū	ū
D0	ē	ē	ē	ē	ē	ē	ē	ē	ē	ē	ē	ē	ē	ē	ē	ē
E0	ī	ī	ī	ī	ī	ī	ī	ī	ī	ī	ī	ī	ī	ī	ī	ī
F0	ō	ō	ō	ō	ō	ō	ō	ō	ō	ō	ō	ō	ō	ō	ō	ō

7x15 Font - International

	00	01	02	03	04	05	06	07	08	09	0A	0B	0C	0D	0E	0F
80	ē	ē	ē	ē	ē	ē	ē	ē	ē	ē	ē	ē	ē	ē	ē	ē
90	ī	ī	ī	ī	ī	ī	ī	ī	ī	ī	ī	ī	ī	ī	ī	ī
A0	ō	ō	ō	ō	ō	ō	ō	ō	ō	ō	ō	ō	ō	ō	ō	ō
B0	ū	ū	ū	ū	ū	ū	ū	ū	ū	ū	ū	ū	ū	ū	ū	ū
C0	ē	ē	ē	ē	ē	ē	ē	ē	ē	ē	ē	ē	ē	ē	ē	ē
D0	ī	ī	ī	ī	ī	ī	ī	ī	ī	ī	ī	ī	ī	ī	ī	ī
E0	ō	ō	ō	ō	ō	ō	ō	ō	ō	ō	ō	ō	ō	ō	ō	ō
F0	ū	ū	ū	ū	ū	ū	ū	ū	ū	ū	ū	ū	ū	ū	ū	ū