

5-60 Watts

DNR Series



- Rugged Design for Industrial Applications
- Up to 89% Efficiency
- Full Power to +60 °C
- Wide Adjustment Range
- DC OK 24 V Models
- DC Standby Versions
- 3 Year Warranty

Specification

Input

Input Voltage	• 90-264 VAC, 120-375 VDC (DNR05/10/18) 85-264 VAC, 90-375 VDC (DNR30/60)
Input Frequency	• 47-63 Hz
Input Current	• See tables
Inrush Current	• 5-18 W: 10/18 A at 115/230 VAC 30 W: 20/40 A at 115/230 VAC 60 W: 30/60 A at 115/230 VAC
Power Factor	• EN61000-3-2, class A
Earth Leakage Current	• 0.8 mA max
Input Protection	• Internal fuse T2A, 250 VAC fitted in line

Output

Output Voltage	• See tables
Output Voltage Trim	• See tables
Initial Set Accuracy	• ±1%
Minimum Load	• No minimum load required
Start Up Delay	• <1 s (may increase at low temperature extremes)
Start Up Rise Time	• <150 ms
Hold Up Time	• 30/130 ms at 115/230 VAC (DNR05) 25/100 ms at 115/230 VAC (DNR10) 20/75 ms at 115/230 VAC (DNR18) 20/30 ms at 115/230 VAC (DNR30) 20/30 ms at 115/230 VAC (DNR60)
Line Regulation	• 5-18 W: ±1.0% max 30-60 W: ±0.5% max
Load Regulation	• 5-18 W: ±2.0% max 30-60 W: ±0.5% max
Parallel Operation	• Redundancy module DPM10 available for load currents up to 10 A (not with standby system), contact sales
Transient Response	• 4% max deviation recovery to within 1% in 2 ms for a 50% load change
Ripple & Noise	• 50 mV pk-pk, 20 MHz bandwidth (may increase at low temperature extremes)
Overvoltage Protection	• Output clamps at 120-145% Vnom, auto recovery
Overload Protection	• 110-145% constant current (DNR05-18) 105-150% power limited (DNR30/60)
Short Circuit Protection	• Power limited, auto recovery
Temperature Coefficient	• ±0.03%/°C

General

Efficiency	• See tables
Isolation	• 3000 VAC Input to Output, 1500 VAC Input to Ground, 500 VAC Output to Ground
Switching Frequency Signals	• 132 KHz typical, 55-90 kHz (DNR60)
MTBF	• DC ON indicator LED Green: All models DC LOW indicator LED Red: 5-18 W models DC OK: 24 V 30-60 W models DC OK: All standby models
DIN Rail	• 800 kHrs typical Bellcore, Issue 6 at +40 °C, GB (DNR05/10/18), 530 kHrs typical Bellcore, Issue 6 at +40 °C, GB (DNR30/60)
	• Compatible with TS35/7.5 or TS35/15

Environmental

Operating Temperature	• -20 °C to +70 °C (DNR05/10/18) -40 °C to +70 °C, start up at -35 °C (DNR30/60), all units derate linearly from 60 °C (see derating curves)
Cooling	• Convection-cooled with 25mm free space all sides
Operating Humidity	• 20-95% RH, non-condensing
Storage Temperature	• -25 °C to +85 °C (DNR05/10/18) -40 °C to +85 °C (DNR30/60)
Shock	• 15 g, 11 ms, X, Y & Z axis, 3 shocks/axis in both directions
Vibration	• 2 g, 10 Hz to 500 Hz, along X, Y & Z axis, 60 mins/axis, mounted on rail

EMC & Safety

Emissions	• EN55022, level B conducted & radiated
Harmonic Currents	• EN61000-3-2, class A
Voltage Flicker	• EN61000-3-3
ESD Immunity	• EN61000-4-2, level 4, Perf Criteria A
Radiated Immunity	• EN61000-4-3, level 3, Perf Criteria A
EFT/Burst	• EN61000-4-4, level 4, Perf Criteria A
Surge	• EN61000-4-5, installation class 3, Perf Criteria A
Conducted Immunity	• EN61000-4-6, level 3, Perf Criteria A
Magnetic Field	• EN61000-4-8, level 4 Perf Criteria A
Dips & Interruptions	• EN61000-4-11, 30% 10 ms, 60% 100 ms, 100% 5000 ms Perf Criteria A, B, B
Safety Approvals	• EN60950-1, UL508 Pollution Degree 2, UL1310 class 2 power recognised, See note 3 & ratings table, UL60950-1 Overvoltage Category II, UL508 Overvoltage Category III, DNR30 & DNR60: SEMI F47 ANSI/ISA 12.12.01. Class 1, Division 2 Groups A,B,C and D

Models and Ratings

Output Voltage	Input Current (typ.)		Output Voltage Trim	Output Current	Efficiency (typ.)	Model Number
	115 VAC	230 VAC				
5 V	0.12 A	0.08 A	4.50-5.75 V	1.000 A	69%	DNR05US05 ^(†)
12 V	0.12 A	0.08 A	10.80-13.80 V	0.420 A	72%	DNR05US12 ^(†)
15 V	0.12 A	0.08 A	13.50-17.25 V	0.340 A	72%	DNR05US15 ^(†)
24 V	0.12 A	0.08 A	21.60-28.80 V	0.210 A	72%	DNR05US24 ^(†)
5 V	0.20 A	0.13 A	4.50-5.75 V	2.000 A	73%	DNR10US05 ^{(†)^}
12 V	0.20 A	0.13 A	10.80-13.80 V	0.840 A	75%	DNR10US12 ^{(†)^}
15 V	0.20 A	0.13 A	13.50-17.25 V	0.670 A	76%	DNR10US15 ^{(†)^}
24 V	0.20 A	0.13 A	21.60-28.80 V	0.420 A	76%	DNR10US24 ^{(†)^}
5 V	0.36 A	0.21 A	4.50-5.75 V	3.000 A	75%	DNR18US05 ^{(†)^}
12 V	0.36 A	0.21 A	10.80-13.80 V	1.500 A	77%	DNR18US12 ^{(†)^}
15 V	0.36 A	0.21 A	13.50-17.25 V	1.200 A	77%	DNR18US15 ^{(†)^}
24 V	0.36 A	0.21 A	21.60-28.80 V	0.750 A	77%	DNR18US24 ^{(†)^}
5 V	0.56 A	0.33 A	5.00-5.50 V	6.000 A	79%	DNR30US05 ^{(†)^}
12 V	0.56 A	0.33 A	12.00-14.00 V	2.500 A	84%	DNR30US12 ^{(†)^}
24 V	0.56 A	0.33 A	24.00-28.00 V	1.250 A	86%	DNR30US24 ^{(†)^}
48 V	0.56 A	0.33 A	48.00-55.00 V	0.625 A	86%	DNR30US48 ^{(†)^}
5 V	1.10 A	0.59 A	5.00-5.50 V	10.000 A	79%	DNR60US05 ^{(†)^}
12 V	1.10 A	0.59 A	12.00-14.00 V	5.000 A	86%	DNR60US12 ^{(†)^}
24 V	1.10 A	0.59 A	24.00-28.00 V	2.500 A	89%	DNR60US24 ^{(†)^}
48 V	1.10 A	0.59 A	48.00-55.00 V	1.250 A	89%	DNR60US48 ^{(†)^}

Notes

1. Add suffix '-S' for spring clamp connection option.
 2. 30-60 W models are suitable for battery-charging applications.
 3. Approved to UL1310, but 5 & 12 V not Class 2 Power recognised.
 4. SEMI F47 compliant.
- † Available from Farnell & element14. See pages 284-290. ^ Available from Newark. See pages 291-296.

Derating Curves

DNR05-18 W Models

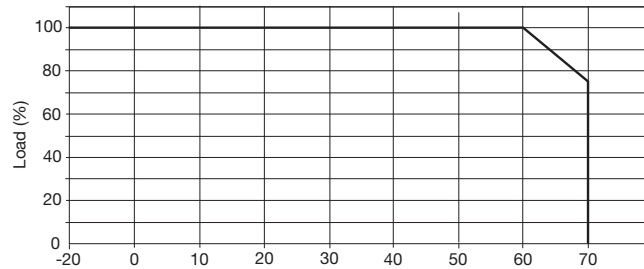

DNR30-60 W Models

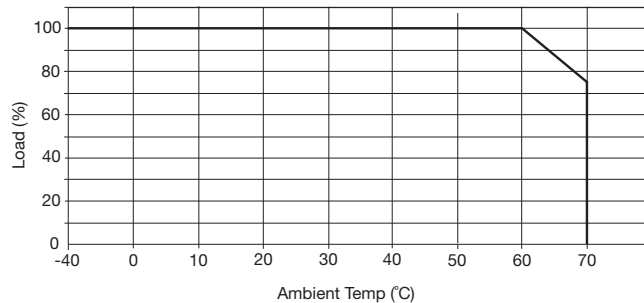

Mechanical Details

DNR05/10/18 W Models

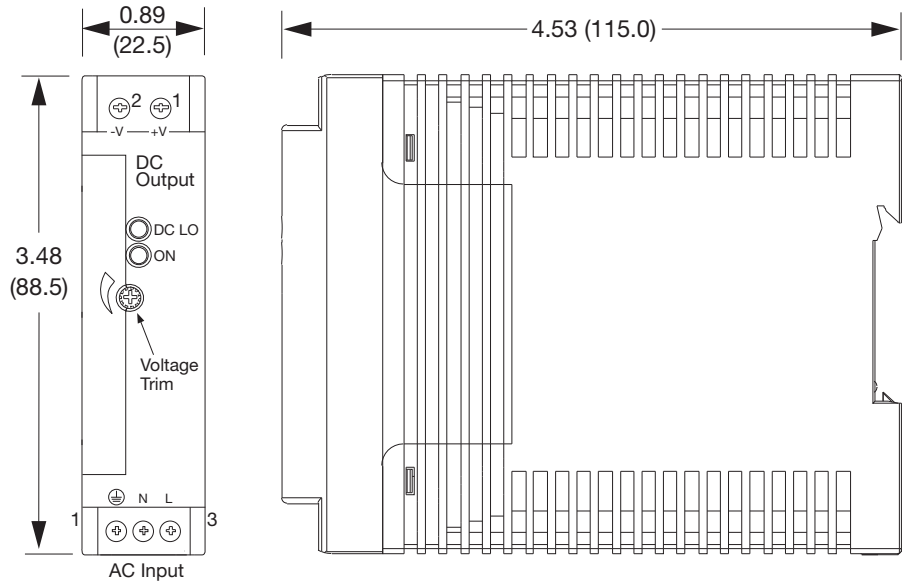

Notes

- 1. All dimensions in inches (mm).
- 2. Weight 0.33 lb (150 g) approx.
- 3. Tolerance: ±0.02 (0.5) maximum.

4. Connection screw maximum torque:
Input: 9 lbs-in (1.0 Nm), Output: 5.5 lbs-in (0.6 Nm)

DNR05, 10, 18 Connections		
Conn	Pin	Designation
AC Input	1	Ground
	2	Neutral
	3	Line
DC Output	1	Positive
	2	Negative

30/60 W Models

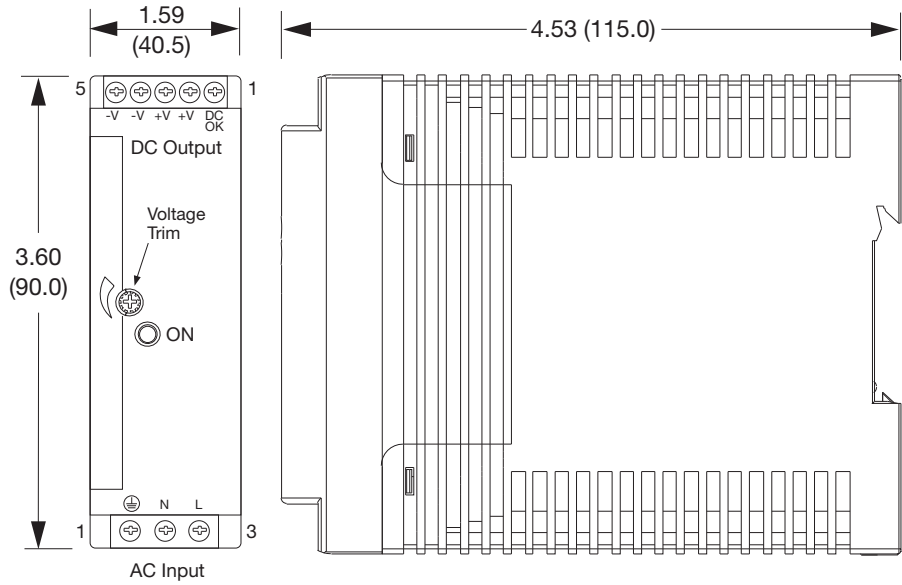

Notes

- 1. All dimensions in inches (mm).
- 2. Weight 0.8 lb (350 g) approx.
- 3. Tolerance: ±0.02 (0.5) maximum.

4. Connection screw maximum torque:
Input: 9 lbs-in (1.0 Nm), Output: 5.5 lbs-in (0.6 Nm)

DNR30/60 Connections		
Conn	Pin	Designation
AC Input	1	Ground
	2	Neutral
	3	Line
DC Output	1	DC OK*
	2	Positive
	3	Positive
	4	Negative
	5	Negative

* 24 V and standby models only.



Standby Versions

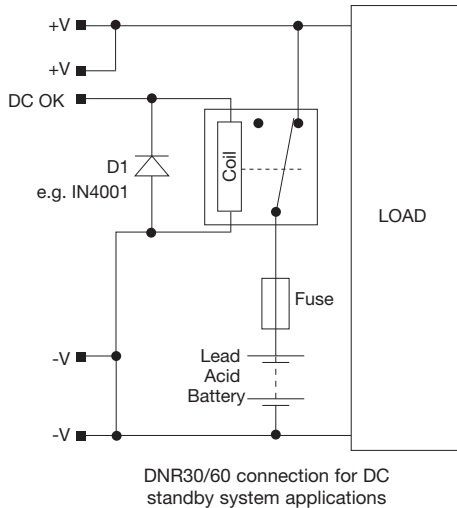
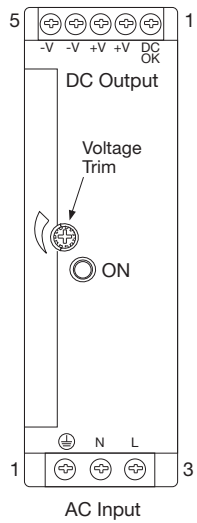

Maximum current drain from battery by PSU when inactive 22 mA

DNR30/60 Connections		
Conn	Pin	Designation
AC Input	1	Ground
	2	Neutral
	3	Line
DC Output	1	DC OK
	2	Positive
	3	Positive
	4	Negative
	5	Negative

Notes

1. With AC in, unit provides power to the load and to charge the battery. The DC OK signal acts by sensing a voltage on +V and holds the relay closed.
2. With loss of AC in, battery voltage is present on +V. DC OK signal holds the relay closed. Battery supplies power to the load.
3. As the battery discharges, its voltage falls. When this falls below the level shown in the table below the DC OK signal switches off to allow the relay to open to disconnect and protect the battery.

Output Set Voltages For Standby Versions				
Model ⁽¹⁾	Voltage	Current	DC OK Signal Off	Efficiency
DNR30US12#	13.6 V	2.20 A	10.30-11.30 V	84%
DNR30US24#	27.2 V	1.10 A	21.10-22.10 V	86%
DNR30US48#	54.5 V	0.55 A	42.70-43.70 V	86%
DNR60US12# ⁽²⁾	13.6 V	4.40 A	10.30-11.30 V	86%
DNR60US24#	27.2 V	2.20 A	21.10-22.10 V	89%
DNR60US48#	54.5 V	1.10 A	42.70-43.70 V	89%

Notes

1. Suffix # indicates standby version.
2. Not UL1310 approved.

DC OK

30/60 W Models

Output good = 24 V Output not good = 0 V

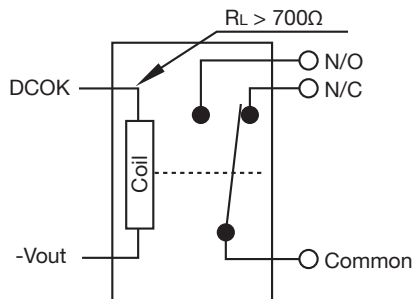

Example using external relay to create volt-free contact

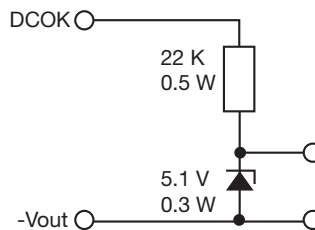

Example using external components to create TTL signal

Standard on 24 V models, 30-60 W only.