

Specification for BTHQ 21603V-SMN-LEDwhite-conn. (1 die)

Version June 2003

DOCUMENT REVISION HISTORY 1:

DOCUMENT REVISION FROM TO	DATE	DESCRIPTION	CHANGED BY	CHECKED BY
A	2002.11.14	First Release	PHILIP CHENG	Z.B.HE
A B	2003.06.24	(Based Test Specification VL-TS-BTHQ 21603VSS-XX REVE, 2003-05-05). Items 1 to 3 were updated: 1.)(Whole document) The description of the module was updated. 2.)(Page 8, table 5) Supply voltage (LCD), current IDD & I0 were updated. Conditions of supply voltage of backlight were updated. 3.)(Page 13 to 14, point 6;page 3) APPENDIX-LED Specifications were updated.	HELEN HE	YU HAO

CONTENTS

	<u>Page No.</u>
1. GENERAL DESCRIPTION	4
2. MECHANICAL SPECIFICATIONS	4
3. INTERFACE SIGNALS	6
4. ABSOLUTE MAXIMUM RATINGS	7
4.1 ELECTRICAL MAXIMUM RATINGS (Ta=25°C)	7
4.2 ENVIRONMENTAL CONDITION	7
5. ELECTRICAL SPECIFICATIONS	8
5.1 TYPICAL ELECTRICAL CHARACTERISTICS	8
5.2 TIMING SPECIFICATIONS	9
5.3 TIMING DIAGRAM OF VDD AGAINST V0	11
5.4 CORRESPONDENCE BETWEEN CHARACTER CODES AND CHARACTER PATTERNS (NOVATEK STANDARD NT3881D-01)	12
6. APPENDIX – LED SPECIFICATIONS	13

**Specification
of
LCD Module Type
Model No.: BTHQ 21603VSS-05**

1. General Description

- 16 characters (5x8 dots) x 2 lines STN Negative Blue Transmissive Dot Matrix LCD module.
- Viewing Angle: 6 O'clock direction.
- Driving scheme: 1/16 Duty, 1/5 bias.
- 'NOVATEK' NT3881DH-01/AI (Die form) LCD Controller and Driver or equivalent.
- 'SAMSUNG' KS0065B-PCC (Die form) 40-Channel Segment/Common Driver for Dot Matrix LCD or equivalent.
- Connector CON-16X1-35: 16 pins x 1 row, pitch=1.00mm,SMD ("FULLCONN", P/N:T03-2000-2160).
- White LED05 backlight.

2. Mechanical Specifications

The mechanical detail is shown in Fig. 1 and summarized in Table 1 below.

Table 1

Parameter	Specifications	Unit
Outline dimensions	53.0(W) x 20.0(H) x 8.5 MAX.(D) (Excluded connector)	mm
Viewing area	36.0(W) x 10.0(H)	mm
Active area	34.10(W) x 7.40(H)	mm
Display format	16 characters x 2 lines	-
Character size	1.85(W) x 3.15(H) (5 x 8 dots)	mm
Character spacing	0.30(W) x 1.10(H)	mm
Character pitch	2.15(W) x 4.25(H)	mm
Dot size	0.358(W) x 0.381(H)	mm
Dot spacing	0.015(W) x 0.015(H)	mm
Dot pitch	0.373(W) x 0.396(H)	mm
Weight:	TBD	grams

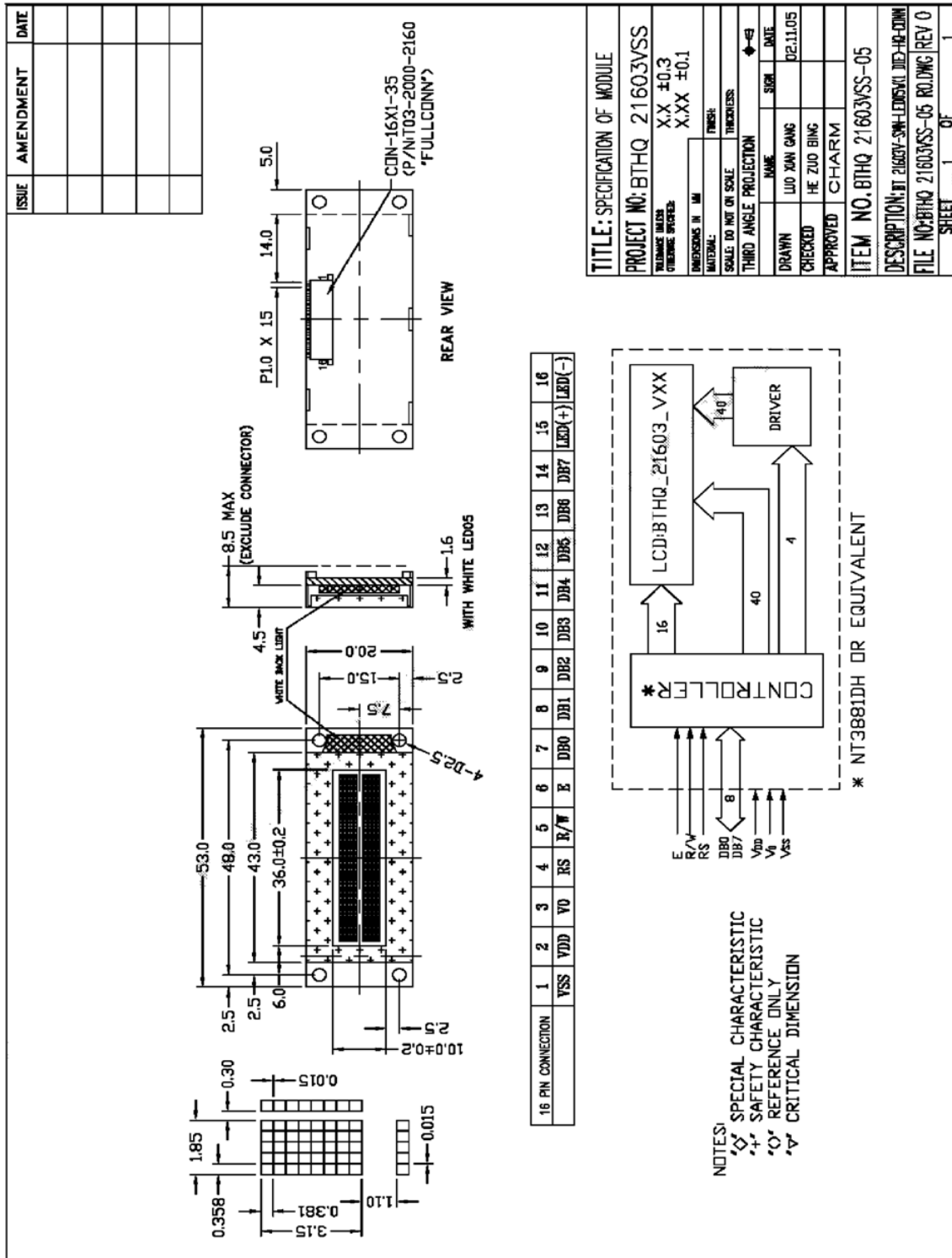

Figure 1: Module Specification

3. Interface signalsTable 2

Pin No.	Symbol	Description
1	VSS	Ground (0V).
2	VDD	Power supply for logic (+5V)
3	V0	Power supply for LCD driver
4	RS	Register Select Input: "High" for Data register (for read and write) "Low" for Instruction register (for write), Busy flag, address counter (for read)
5	R/W	Read/Write signal: "High" for Read mode. "Low" for Write mode.
6	E	Enable. Start signal for data read /write.
7	DB0	Data input/output (LSB)
8	DB1	Data input/output
9	DB2	Data input/output
10	DB3	Data input/output
11	DB4	Data input/output
12	DB5	Data input/output
13	DB6	Data input/output
14	DB7	Data input/output (MSB)
15	LED(+)	Anode of LED backlight
16	LED(-)	Cathode of LED backlight

4. Absolute Maximum Ratings**4.1 Electrical Maximum Ratings (Ta = 25 °C)**Table 3

Parameter	Symbol	Min.	Max.	Unit
Power Supply voltage (Logic)	VDD - VSS	-0.3	+7.0	V
Power Supply voltage (LCD drive)	VLCD=VDD - V0	-0.3	+13.5	V
Input voltage	Vin	-0.3	VDD +0.3	V

Note:

The modules may be destroyed if they are used beyond the absolute maximum ratings.

All voltage values are referenced to VSS = 0V.

4.2 Environmental ConditionTable 4

Item	Operating Temperature (Topr)		Storage Temperature (Tstg)		Remark
	Min.	Max.	Min.	Max.	
Ambient Temperature	0°C	+50°C	-10°C	+60°C	Dry
Humidity	95% max. RH for Ta ≤ 40°C < 95% RH for Ta > 40°C				no condensation
Vibration (IEC 68-2-6) cells must be mounted on a suitable connector	Frequency: 10 ~ 55 Hz Amplitude: 0.75 mm Duration: 20 cycles in each direction.				3 directions
Shock (IEC 68-2-27) Half-sine pulse shape	Pulse duration : 11 ms Peak acceleration: 981 m/s ² = 100g Number of shocks : 3 shocks in 3 mutually perpendicular axes.				3 directions

5. Electrical Specifications**5.1 Typical Electrical Characteristics**

At $T_a = 25\text{ }^\circ\text{C}$, $V_{DD} = 5V \pm 5\%$, $V_{SS} = 0V$.

Table 5

Parameter	Symbol	Conditions	Min.	Typ.	Max.	Unit
Supply voltage (Logic)	VDD-VSS		4.75	5.0	5.25	V
Supply voltage (LCD)	VLCD =VDD-V0	VDD=5.0V, $T_a=0\text{ }^\circ\text{C}$, Note1.	-	4.3	-	V
		VDD=5.0V, $T_a=25\text{ }^\circ\text{C}$, Note1.	3.8	4.2	4.6	V
		VDD=5.0V, $T_a=50\text{ }^\circ\text{C}$, Note1.	-	4.0	-	V
Input signal voltage 1 for E,DB0-DB7,R/W,RS.	V_{IH1}	“H” level	2.2	-	VDD	V
	V_{IL1}	“L” level	-0.3	-	0.8	V
Input signal voltage 2 for OSC1.	V_{IH2}	“H” level	VDD -1.0	-	VDD	V
	V_{IL2}	“L” level	VSS	-	1.0	V
Supply Current (Logic & LCD)	IDD	Character mode, Note 1	-	1.1	1.5	mA
		Checker board mode, Note 1	-	1.2	1.7	mA
Supply Current (LCD)	I0	Character mode, Note 1	-	0.2	0.3	mA
		Checker board mode, Note 1	-	0.2	0.3	mA
Supply voltage of white LED05 backlight	VLED	Forward current =20mA Number of LED dies =1	3.1	3.4	3.7	V

Note (1) : There is tolerance in optimum LCD driving voltage during production and it will be within the specified range.

5.2 Timing Specifications

At Ta = 0 °C To +50 °C, VDD = +5V±5%, VSS = 0V.

Refer to Fig. 2, the bus timing diagram for write mode.

Table 6

Parameter	Symbol	Min.	Max.	Unit	Remarks
Enable cycle time	t _{CYCE}	500	-	ns	
Enable "High" level pulse width	t _{WHE}	300	-	ns	
Enable rise time	t _{RE}	-	25	ns	
Enable fall time	t _{FE}	-	25	ns	
RS, R/W set-up time	t _{AS}	60	-	ns	8-bit operation mode
		100			4-bit operation mode
RS, R/W address hold time	t _{AH}	10	-	ns	
Data output delay	t _{DS}	100	-	ns	
Data hold time	t _{DHR}	10	-	ns	

Refer to Fig. 3, the bus timing diagram for read mode .

Table 7

Parameter	Symbol	Min.	Max.	Unit	Remarks
Enable cycle time	t _{CYCE}	500	-	ns	
Enable "High" level pulse width	t _{WHE}	300	-	ns	
Enable rise time	t _{RE}	-	25	ns	
Enable fall time	t _{FE}	-	25	ns	
RS, R/W set-up time	t _{AS}	60	-	ns	8-bit operation mode
		100			4-bit operation mode
RS, R/W address hold time	t _{AH}	10	-	ns	
Read data output delay	t _{RD}	-	190	ns	
Read data hold time	t _{DHR}	20	-	ns	

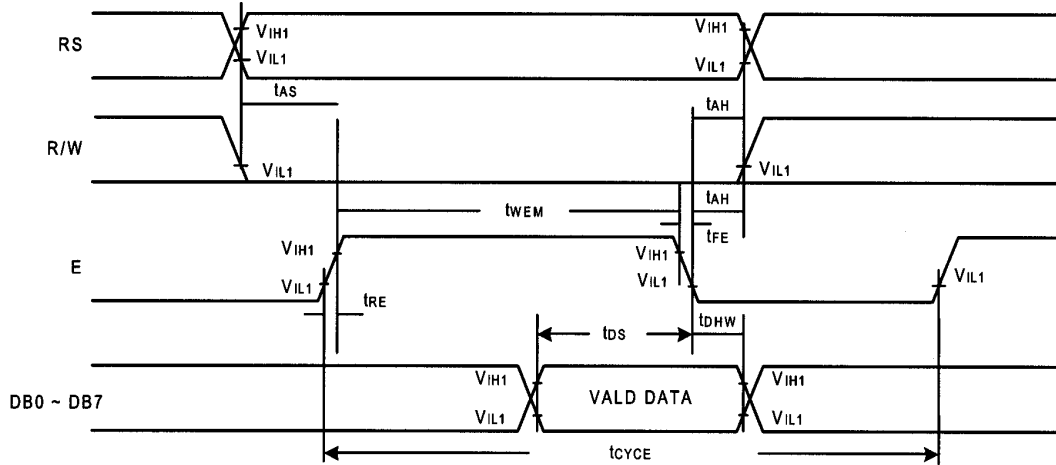

Figure 2: Bus write operation sequence (Writing data from MPU to NT3881D).

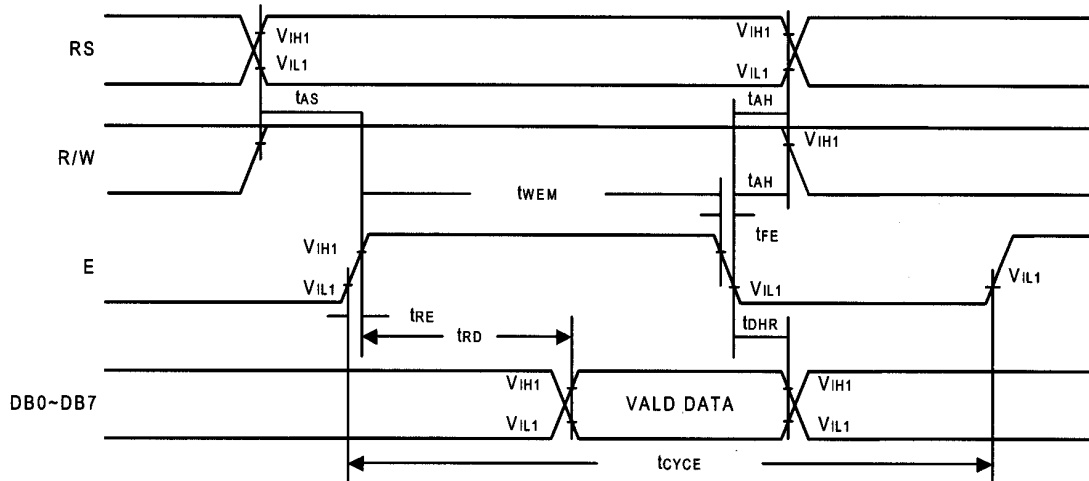

Figure 3: Bus read operation sequence (Reading out data from NT3881D to MPU).

5.3 Timing Diagram of VDD against V0.

Power on sequence shall meet the requirement of Figure 4, the timing diagram of VDD against V0.

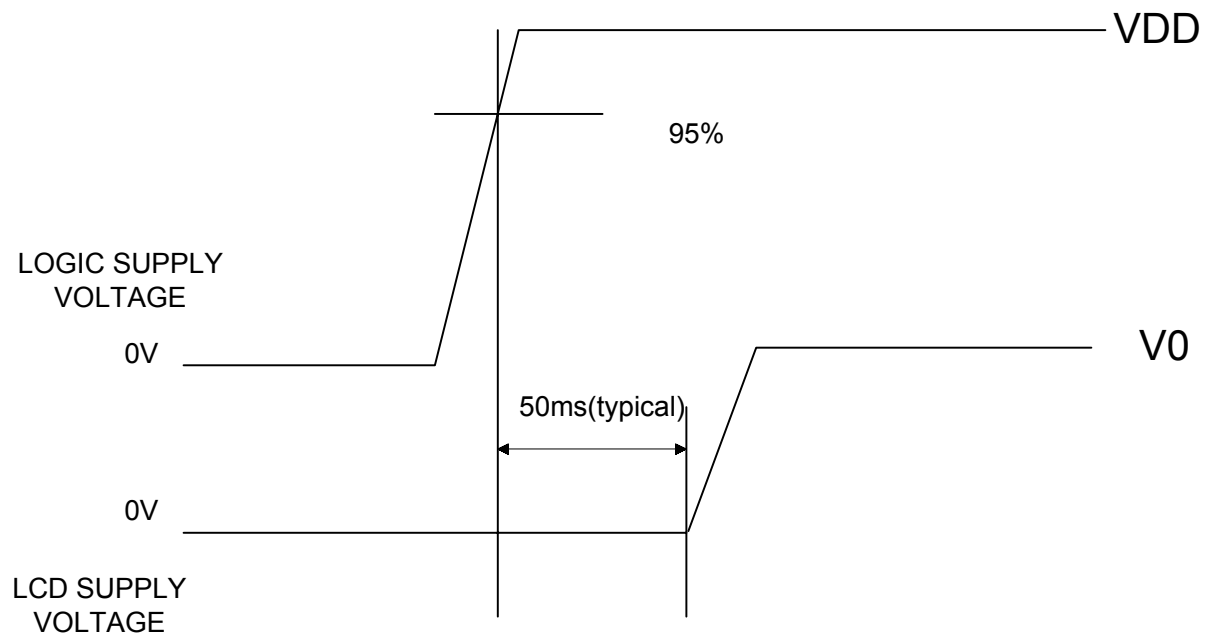

Figure 4: Timing diagram of VDD against V0.

5.4 Correspondence between Character Codes and Character Patterns (NOVATEK Standard NT3881D-01)

		Higher 4-bit (D4 to D7) of Character Code (Hexadecimal)																
		0	1	2	3	4	5	6	7	8	9	A	B	C	D	E	F	
Lower 4-bit (D0 to D3) of Character Code (Hexadecimal)	0	CG RAM (1)			0	a	P	`	P					一	夕	三	α	ρ
	1	CG RAM (2)		!	1	A	Q	a	q			□	ア	チ	△	ä	q	
	2	CG RAM (3)		"	2	B	R	b	r			「	イ	ツ	×	β	θ	
	3	CG RAM (4)		#	3	C	S	c	s			」	ウ	テ	モ	ε	ω	
	4	CG RAM (5)		\$	4	D	T	d	t			、	エ	ト	ト	μ	Ω	
	5	CG RAM (6)		%	5	E	U	e	u			。	オ	ナ	ユ	δ	Ü	
	6	CG RAM (7)		&	6	F	V	f	v			ヲ	カ	ニ	ヨ	ρ	Σ	
	7	CG RAM (8)		'	7	G	W	g	w			ア	キ	ヌ	ウ	g	π	
	8	CG RAM (1)		(8	H	X	h	x			イ	ク	ネ	リ	ル	×	
	9	CG RAM (2))	9	I	Y	i	y			ウ	ケ	ル	ル	リ	γ	
	A	CG RAM (3)		*	:	J	Z	j	z			エ	コ	ン	レ	ル	≠	
	B	CG RAM (4)		+	:	K	[k]			オ	サ	ヒ	ロ	°	万	
	C	CG RAM (5)		,	<	L	¥	l	l			ヤ	シ	フ	ワ	φ	円	
	D	CG RAM (6)		-	=	M]	m]			ユ	ヌ	ハ	ン	ト	÷	
	E	CG RAM (7)		.	>	N	^	n	→			ヨ	セ	ホ	°	ん		
	F	CG RAM (8)		/	?	O	_	o	+			ッ	リ	マ	°	ö		

6. APPENDIX – LED Specifications

1. 极限参数 ABSOLUTE MAXIMUM RATINGS

(除非特别说明,环境温度 Ta=25°C. Unless specified, The Ambient temperature Ta=25°C)

项目 Item	符号 Symbol	条件 Conditions	值 Rating	单位 Unit
* 极限直流正向电流 Absolute maximum forward current	Ifm		30	mA
* 脉冲驱动时极限正向电流 Peak forward current	Ifp	1 msec 脉冲, 1/10 占空比 1 msec Plus 10% Duty Cycle	60	mA
反向电压 Reverse Voltage	Vr		5	V
* 极限功耗 Power dissipation	Pd		75	mW
工作温度 Operating Temperature Range	Topr		-30~+70°C	°C
贮存温度 Storage Temperature Range	Tstg		-40~+80°C	°C

- * 当工作温度高于 25°C 时, Ifm, Ifp 和 Pd 必须降低; 电流降低率是 -0.36 mA/°C(直流驱动), 或 -0.86 mA/°C(脉冲驱动), 功耗降低率是 -0.75 mW/°C. 产品的工作电流不能大于对应工作温度条件 Ifm 或 Ifp 的 60 %.
- For operation above 25°C, The Ifm Ifp & Pd must be derated, the Current derating is -0.36 mA/°C for DC drive and -0.86 mA/°C for Pulse drive, the Power dissipation is -0.75 mW/°C. The product working current must not more than the 60 % of the Ifm or Ifp according to the working temperature.

2. 电、光特性 ELECTRICAL-OPTICAL CHARACTERISTICS

(除非特别说明,环境温度 Ta=25°C. Unless specified, The Ambient temperature Ta=25°C)

项目 Item	符号 Symbol	最小值 min.	典型值 typ.	最大值 max.	单位 Unit	测定条件 Condition
正向电压 Forward Voltage	Vf	3.1	3.4	3.7	V	If= 20 mA
反向电流 Reverse Current	Ir			15	μA	Vr= 3 V
峰值波长 Peak wave length	λP				nm	If= 20 mA
频谱半宽度 Spectral Line Half width	Δλ				nm	If= 20 mA
* 亮度 Luminance	Lv	100			cd/m ²	If= 20 mA

- * 亮度值是 3 个测量点的平均值, 亮度最大值比最小值一般小于 1.5.

使用 BM-7 亮度色度仪测量, 测量光圈 φ 5 mm.

The luminance is the average value of 3 points, and The Lvmax./Lvmin. is less than 1.5 Typical.

The measurement instrument is BM-7 luminance Colorimeter. The aperture is φ 5 mm.

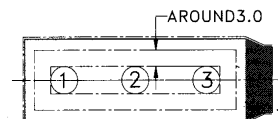

20030623

3. STATIC ELECTRICITY AND SURGE

- * Static electricity and surge will damage the LEDs. It is recommended to use a wrist band or anti-electrostatic glove when handling the LEDs.
- * All devices, equipment and machinery must be properly grounded.
- * When inspecting own final products on which LEDs were mounted, it is recommended to check also whether the mounted LEDs are damaged by static electricity or not. It is easy to find static-damaged LEDs by light emission test at lower current (below 1mA is recommended). Damaged LEDs will show some unusual characteristics such as leak current remarkably increases, starting forward voltage becomes lower, or the LEDs get unlighted at the low current.

4. RECOMMEND CONNECTION OF STATIC-ELECTRICITY RESISTANCE

- * This circuit diagram is a common ESD protection circuit for all super bright blue, white and green color LED backlight application.

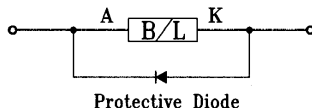

5. LED ELECTRICAL CHARACTERISTICS

(1) 正向电流-周围温度

Forward Current VS. Ambient Temperature

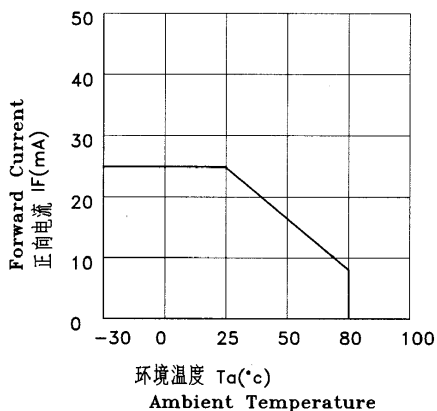

(2) 正向电流-正向电压特性

Forward Current VS. Forward Voltage

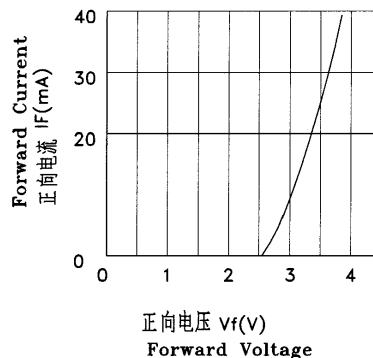

6. 色度坐标 CHROMATICS COORDINATES

White Limiting Region				
X	0.270	0.270	0.330	0.330
Y	0.230	0.275	0.365	0.320

注: 色度坐标值公差±0.02

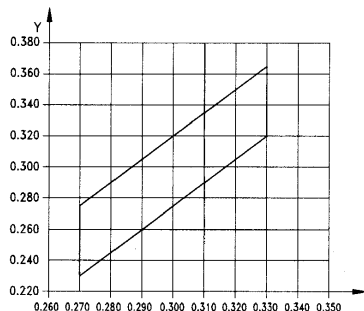

20030623