

- GSM and GPRS
- Voice / Fax / SMS and Data
- Quad Band 850 / 900 / 1800 1900 MHz
- Accepts Standard SIM Card
- Miniature size 88 x 60 x 26mm
- Can Be Used On Standard GSM Network
- RS232 Interface
- One user programmable input/Output Port
- GSM100T: TCP/IP stack available for data and internet
- AT command set:
GSM 07.05 and 07.07 and WAVECOM
- GPRS Class B Class 10:
36Kbps download / 24Kbps upload



Compact "Plug And Play" Quad band GSM modems can be directly connected to the serial port of a desktop or notebook computer through the RS232 interface. A standard SIM card can be inserted in the integral card-holder within the metal enclosure.

The modems' metal casing makes it an appropriate solution for tough industrial applications such as Telemetry, Wireless Local Loop (payphones) or as part of a fleet management system. The small size makes it simple to integrate in a space constraint environment. The modem is supplied with power cable. Other accessories available are an antenna (with 1m coax cable), RS232 connecting cable with Telephone interface, DIN Rail mounting adaptor and power supply unit.

About GPRS: GPRS stands for General Packet Radio Services. The user can remain "ON" all the time and the data communication speed rivals that of a cable modem.

Ordering Information

Part No	Description
GSM100	GSM Quad Band Modem, GPRS Class 10
GSM100T	As GSM100 with Additional TCP/IP Stack
GSM20-ANT	Antenna with flying lead and connector
GSM20-CAB232	RS232 Cable Interface to PC
GSM20-DINRL	DIN Rail Mount Bracket
GSM20-PSU	Power Supply (12Vdc to 110-240Vac)



CONTENTS

SAFETY PRECUTIONS	2
CHAPTER 1 INTRODUCTION	3
CHAPTER 2 INSTALLATION	7
CHAPTER 3 WORKING WITH MAESTRO 100	9
CHAPTER 4 SPECIFICATION	12
CHAPTER 5 APPENDIX	13
CHAPTER 6 TROUBLESHOOTING	14



SAFETY PRECUTIONS

- The modem generates radio frequency (RF) power. When using the modem care must be taken on safety issues related to RF interference as well as regulations of RF equipment.
- Do not use your phone in aircraft, hospitals, petrol stations or in places where using GSM products is prohibited.
- Be sure that the modem will not be interfering with nearby equipment. For example: pacemakers or medical equipment. The antenna of the modem should be away from computers, office equipment, home appliance, etc.
- An external antenna must be connected to the modem for proper operation. Only uses approved antenna with the modem. Please contact authorized dealer on finding an approved antenna.
- Always keep the antenna with minimum safety distance of 26.6 cm or more from human body. Do not put the antenna inside metallic box, containers, etc.

Using the modem in vehicle

- Check for any regulation or law authorizing the use of GSM in vehicle in your country before installing the modem
- Install the modem by qualified personnel. Consult your vehicle dealer for any possible interference of electronic parts by the modem.
- The modem should be connected to the vehicle's supply system by using a fuse-protected terminal in the vehicle's fuse box
- Be careful when the modem is powered by the vehicle's main battery. The battery may be drained after extended period.

Protecting your modem

- To ensure error-free usage, please install and operate your modem with care. Do remember the following:
- Do not expose the modem to extreme conditions such as high humidity/rain, high temperatures, direct sunlight, caustic/harsh chemicals, dust, or water.
- Do not try to disassemble or modify the modem. There is no user serviceable part inside and the warranty would be void.
- Do not drop, hit or shake the modem. Do not use the modem under extreme vibrating condition.
- Do not pull the antenna or power supply cable. Attach/ detach by holding the connector.
- Connect the modem only according to the instruction manual. Failure to do it will void the warranty.
- In case of problem, please contact authorized dealer.

CHAPTER 1 INTRODUCTION

Maestro 100 is a ready-to-use GSM modem for voice, data, fax and SMS services. It also supports GPRS Class 10 for hi-speed data transfer. Maestro 100 can be easily controlled by using AT command for all kinds of operations. With standard 9-pin RS232 port and telephone-like audio plug (via optional cable) the Maestro 100 can be set up with minimal effort.

1.1. Package

The Maestro 100 package should include the following:

1. Maestro 100 or 100T x 1
2. Power cord with fuse x 1
3. Safety note x 1

1.2. Interfaces

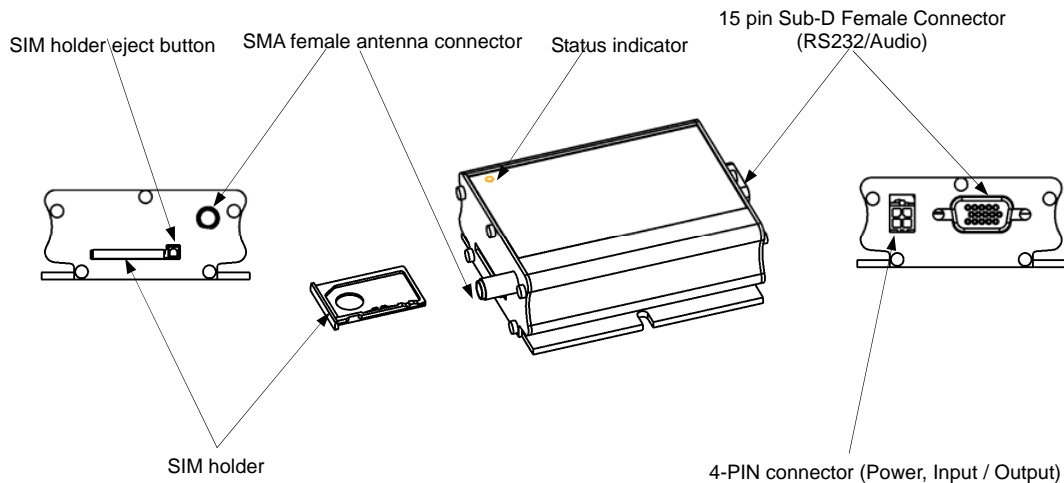

1.2.1. Status indicator

The LED will indicate different status of the modem:

- off Modem switched off
- on Modem is connecting to the network
- flashing slowly Modem is in idle mode
- flashing rapidly Modem is in transmission/communication (GSM only)

1.2.2. SMA female antenna connector

- Connect this to an external antenna with SMA male connector. Make sure the antenna is for the correct GSM frequency with impedance of 50ohm, and also connector is secured tightly.

1.2.3. 15-PIN D-SUB Female connector (RS232 / Audio)

- The connector provides serial link and audio link to the modem.

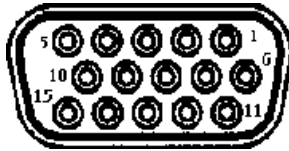

Pin number	Name	EIA designation	Type	Note
1	DCD	Data Carrier Detect	Output	
2	TX	Transmit Data	Input	
3	BOOT		Input	Not used
4	MICROPHONE (+)		Input	With 2V DC bias output
5	MICROPHONE (-)		Input	
6	RX	Receive Data	Output	
7	DSR	Data Set Ready	Output	
8	DTR	Data Terminal Ready	Input	
9	GND	Ground	Ground	
10	SPEAKER(+)		Output	
11	CTS	Clear to Send	Output	
12	RTS	Request to Send	Input	
13	RI	Ring Indicator	Output	
14	RESET		Input	Pull low to reset
15	SPEAKER(-)		Output	

Specification of microphone and speaker to be connected :

Parameters	Min	Typical	Max	Remark
Microphone current @2V / 2K Ohm		0.5 mA		
Microphone input level			100 mVpp	
Speaker output current 150 Ohm/ 1nF		16mA		
Speaker impedance	32ohm	50ohm		

Please refer to the document "Application notes - Power supply & Audio" for more information of audio connection.

1.2.4. 4-PIN connector (Power, Input / Output)

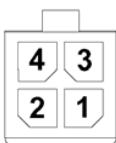

Pin assignment of 4-pin connector

Pin number	Name	Functions
1	I/O	Input / Output port
2	~INTR	Interrupt function triggered by pulling this pin to ground or LOW level; reserved for additional functions with new firmware
3	POWER -	DC power negative input
4	POWER+	DC power positive input

A cable, included in the package shall be used for power supply connection:

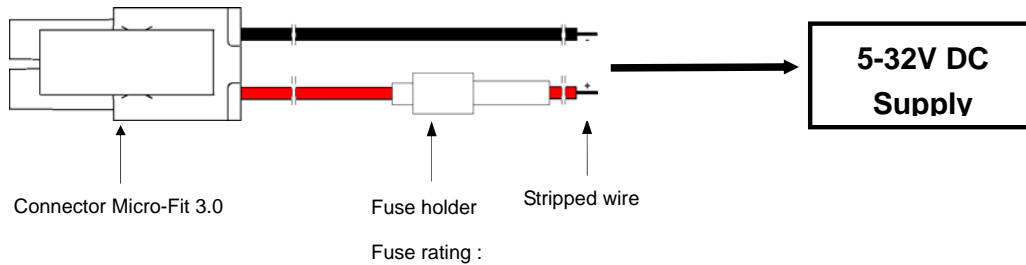

I/O

Parameters	Min	Typical	Max	Remark
I/O In LOW voltage			0.5V	
I/O In HIGH voltage	3V		5V	
I/O out max. sink current			5mA	Internal 1k resistor in series

INTR

Parameters	Min	Typical	Max	Remark
Input LOW voltage	0		0.5V	Triggered by pulling this pin to LOW level ; otherwise leave it open

- Please refers to Chapter 6 Appendix for using I/O and INTR signals. Contact your dealer if you need wire for the I/O and INTR connection

1.2.5 Optional accessories

You may contact your sales agent for the following optional accessories:

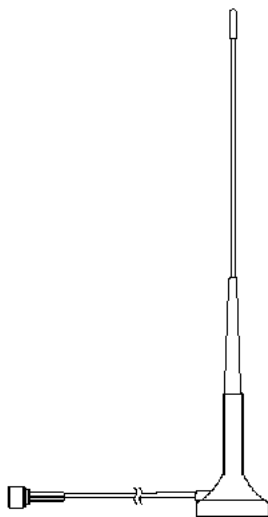

External antenna

- Magnetic mount type
- Frequency GSM 900/1800 band
- Gain 3db
- VSWR < 1.5:1
- Height ~ 236 mm (including magnetic base)
- Cable : Type RG-174U length 2.5m

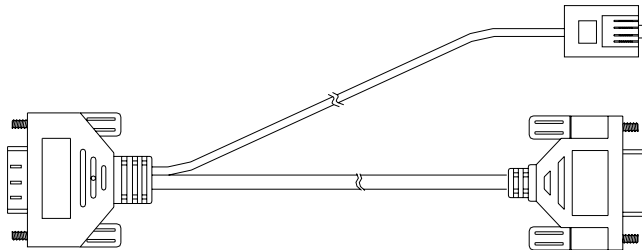

'Y' cable

- Direct connection with standard 9-pin RS-232 port (DTE)
- Direct connection with common handset of telephone for voice call
- Shielded cable
- Cable length 1.1m (w/ connector)

Pin Assignment

Sub-D 15 (male)	Sub-D 9 (female)	Plug 4P4C
1	1	
2	3	
3		
5		4
6	2	
7	6	
8	4	
9	5	
10		2
11	8	
12	7	
13	9	
14		
15		3

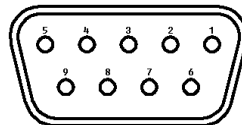

Sub-D 9 pin

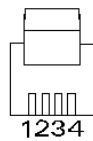

4p4c plug

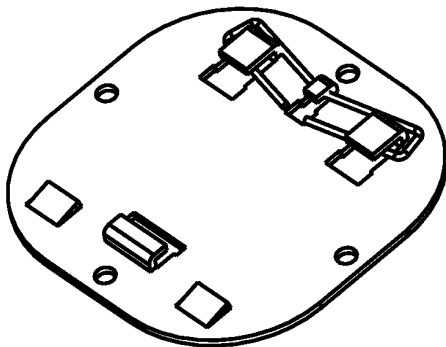

DIN rail mount

- Quick attachment / detachment to standard DIN rail

CHAPTER 2 INSTALLATION

2.1 Mounting the modem

Use 2 pcs of M3 screw to mount the modem

When using optional DIN rail mount please refer to document "Installation of DIN rail mount"

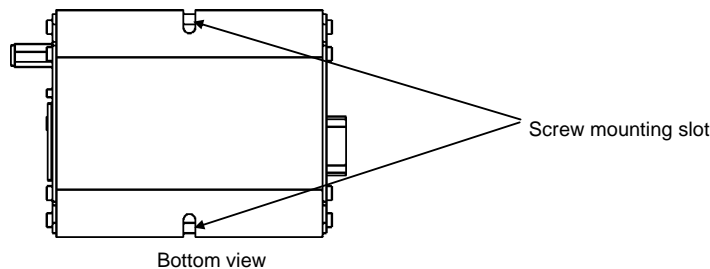

2.2 Installing the SIM card

Use a ball pen or paper clip to press the SIM holder eject button. The SIM holder will come out a little. Then take out the SIM holder.

Note : DO NOT pull out the SIM holder without pushing the eject button.

Put the SIM card to the tray, make sure it has completely sit on the tray. Put the tray back into the slot.

2.3 Connecting the external antenna (SMA type)

Connect this to an external antenna with SMA male connector. Make sure the antenna is for the GSM frequency with impedance of 50ohm, and also connector is secured tightly.

Note : Please use antenna designed for GSM device operation. Incorrect antenna will affect communication and even damage the modem.

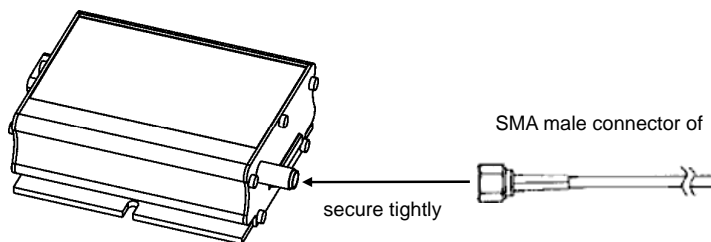

2.4 Connect the modem to external device

You can use the optional 'Y' cable to connect the modem's Sub-D connector to external controller/computer. Note : The modem CANNOT be connected to the 'Line' jack of a landline telephone directly.

Connection example using optional 'Y' cable:

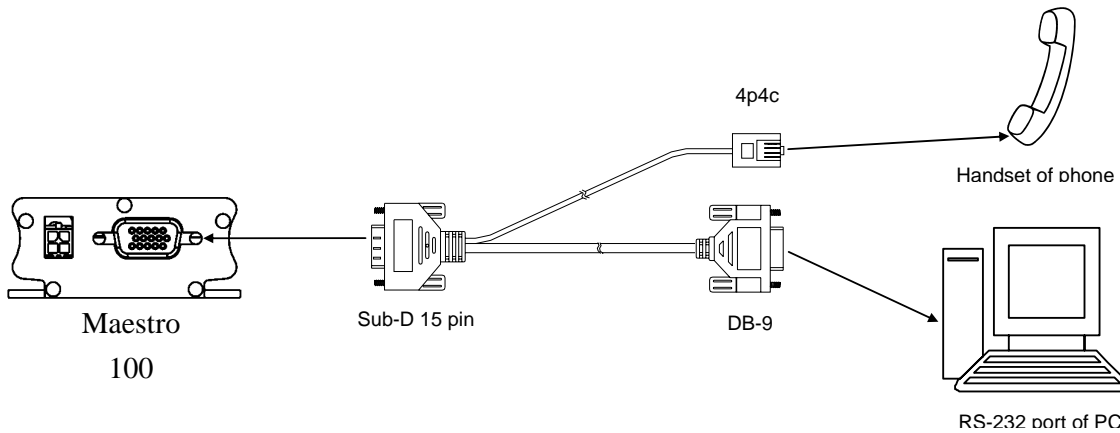

2.5 Connecting the DC power supply

Connect the open ending of the included power cord to a DC supply. Refer to the following for power supply requirement.

Input voltage range	5V – 32V
Rated current	650 mA

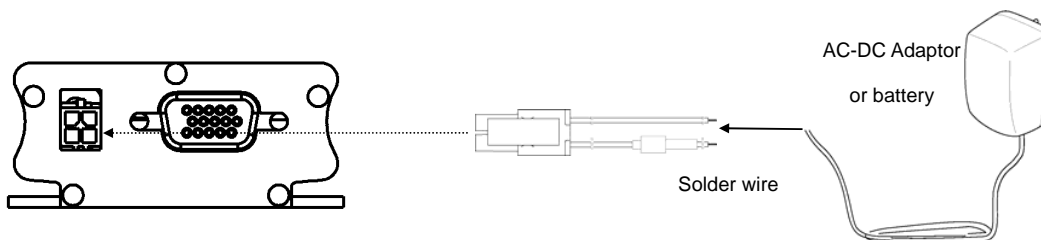

Connect the connector to the modem. The modem will turn on automatically.

The status indicator on the modem will be lit when power on. After a few seconds it will go flashing slowly (registered to the network successfully, refer section 1.2.1).

Chapter 3 describes how to communicate with the modem in Microsoft Windows™ environment.

CHAPTER 3

WORKING WITH MAESTRO 100

3.1. Checking the modem (using Microsoft Windows XP HyperTerminal as example)

3.1.1. On the first time power-up you can use a terminal software to communicate with the modem through an RS-232 serial port. Following example is using the HyperTerminal in Windows XP .

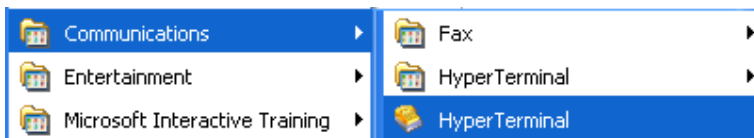

3.1.2. On Windows XP, start the HyperTerminal program. Assign a name for a new session.



3.1.3. Choose the correct Com port and baud rate settings (9600bps for Eco; 115200bps for others, 8bits, no parity bit, 1 stop bit).

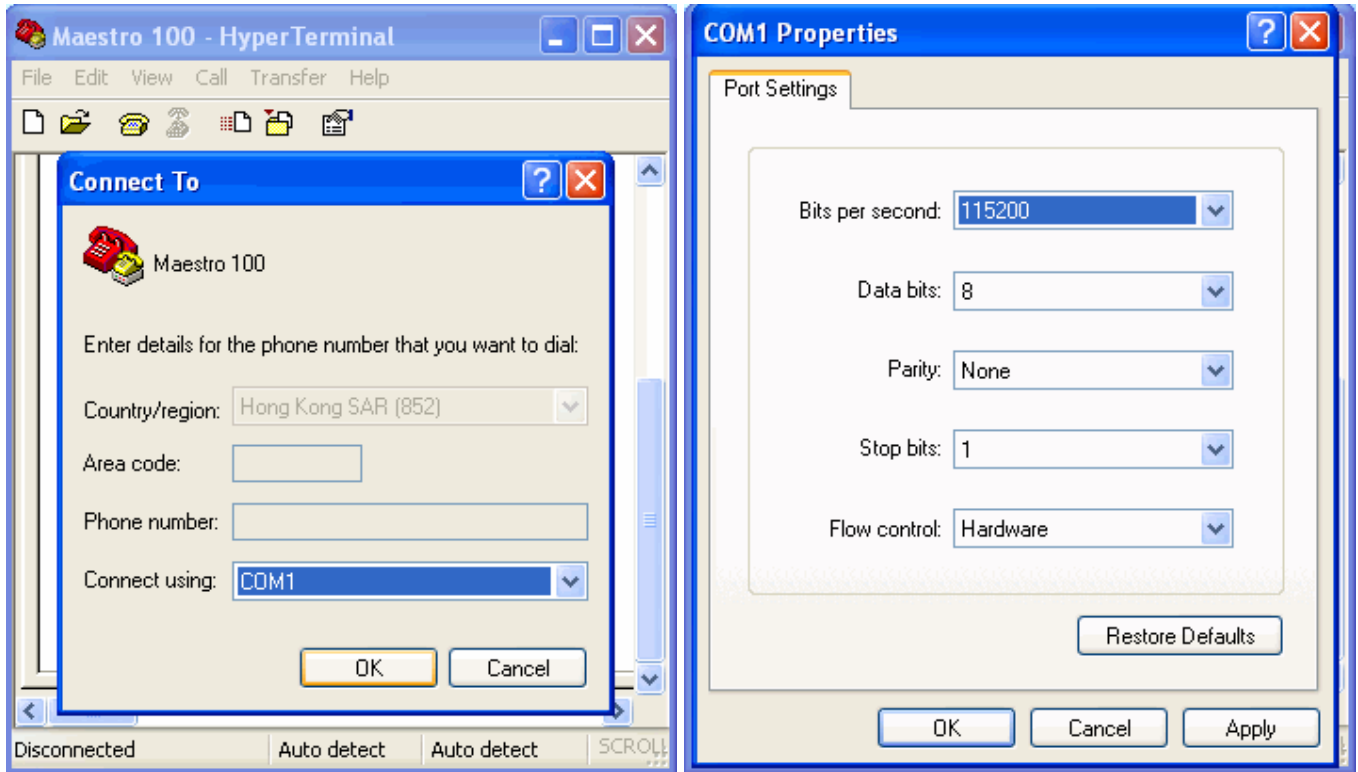

3.1.4. On the terminal screen, type "AT" to check the "OK" response from the modem

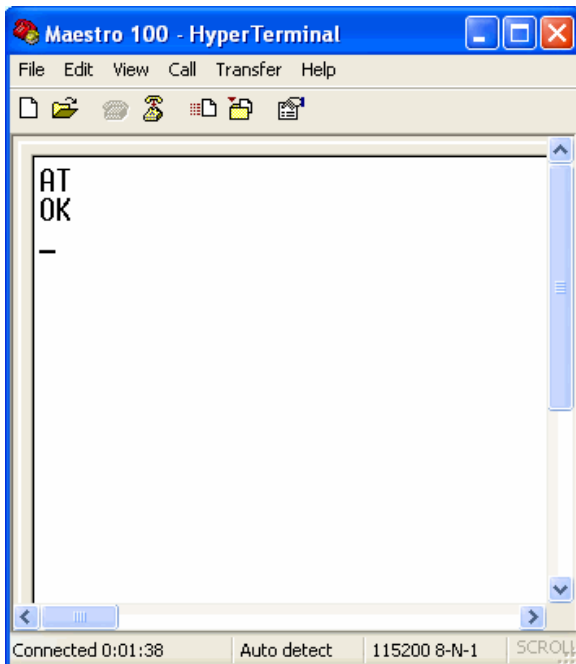

3.2. Basic Operation :

Followings are examples of some AT commands. Please refer to the AT Command guide for a full description.

Note : Issue AT+CMEE=1 to have extended error code (+CME ERROR)

Description	AT commands	Modem response	Comments
Network Registration Checking	AT+CREG?	CREG=<mode>,1	Modem registered to the network
		CREG=<mode>,2	Registration lost, re-registration attempt
		CREG=<mode>,0	Modem not registration on the network, no registration attempt
Receiving signal strength	AT+CSQ	+CSQ: 20,0	The first parameter has to be at least 15 for normal communication
Receiving an incoming call		RING	An incoming call is waiting
	ATA		Answer the call
		OK	
Make a call	ATD1234567;		Don't forget the « ; » at the end for « voice » call
		OK	Communication established
		CME ERROR : 11	PIN code not entered (with + CMEE = 1 mode)
		CME ERROR : 3	AOC credit exceeded or a communication is already established
		CME ERROR : 10	Cannot read the SIM card
Make an emergency call	ATD 112;		Don't forget the « ; » at the end for « voice » call
		OK	
Communication loss		NO CARRIER	
Hang up	ATH		
		OK	
Enter PIN code	AT+CPIN=1234		
		OK	PIN Code accepted
		+CME ERROR : 16	Incorrect PIN Code (with +CMEE = 1 mode)
		+CME ERROR : 3	PIN already entered (with +CMEE = 1 mode)
Saves parameters in non-volatile memory	AT&W		
		OK	The configuration settings are stored

CHAPTER 4 SPECIFICATION

- Bands 850 / 900 / 1800 / 1900 Mhz
- Support Data, SMS, Voice and Fax
- Max Power Output: 2W(900Mhz), 1W(1800Mhz)
- Group 3 FAX support (Class 1 and 2)
- GPRS Class B Class 10 (4Rx+1Tx or 3Rx+2Tx) at maximum speed.*
- SimToolKit Class 2
- AT command set (GSM 07.05, GSM 07.07 and WAVECOM proprietary)

* Note : Available slot for GPRS connection is network dependent.

Power requirement

Input voltage range	5V – 32V
Rated current	650 mA

Typical current consumption

	@5V	@12V	@32V
GSM850 communication mode PCL5	310mA	130mA	50mA
EGSM900 communication mode PCL5	310mA	130mA	50mA
DCS1800 communication mode PCL0	240mA	100mA	40mA
PCS1900 communication mode PCL0	240mA	100mA	40mA
GPRS850 Class 10	520mA	220mA	80mA
GPRS900 Class 10	520mA	220mA	80mA
GPRS1800 Class 10	390mA	160mA	70mA
GPRS1900 Class 10	390mA	160mA	70mA
Idle mode	35mA	16mA	8mA
Idle mode with power saving on RS232	12mA	11mA	5mA

Dimensions:

- Overall size : 88mm x 60mm x 26mm
- Weight : 100g
- Temperature range: operating -30°C to +75°C (Ext model) -20°C to +55°C (other models)
storage -40°C to +85°C (Ext model) -25°C to +70°C (other models)

CHAPTER 5 APPENDIX

5.1 Factory settings

The modem has the following factory settings. Please refer to the AT command document for the meaning of each setting.

Related AT commands	Factory Settings	Description
AT+IPR	115200 (9600 for Eco)	DTE-DCE data rate
AT+IFC	2,2	DTE-DCE flow control
AT+ICF	3,4	DTE-DCE character framing
ATE	1	ECHO
AT&C	1	DCD signal
AT&D	2	DTR signal
ATQ	0	Result code suppression
ATV	1	Response format
AT&S	1	DSR signal
ATS0	0	Auto answer
AT+CLIP	0	Calling line ID presentation
AT+CRLP	0	Calling line ID restriction
AT+CSCS	"PCCP437"	Character set
AT+CMGF	1	Short Message format
AT+CSMP	1,67,0,0	Text mode parameters *
AT+CNMI	0,1,0,0	New message indication *

*Note: settings stored in SIM, not in modem

5.2 Input / Output port

This port can be configured as either an input one or an output one.

To configure it as an input port, first issue AT+WIOW=2, 0 to disable the output port. Use AT+WIOR=3 to read the status of this input port. Response +WIOR: 0 represent Logic HIGH (>3V); Response +WIOR: 1 represent Logic LOW (<0.5V) To use it as an output port, issue AT+WIOW=2,1 will turn it on and it will drain current to ground. The current is recommended not to exceed 5 mA. Issue AT+WIOW=2,0 will turn it off.

5.3 RS232 AUTO-ONLINE mode (power saving)

When being in the AUTO-ONLINE, the RS232 transceiver will shutdown most of its hardware to save power if it does not detect a valid input for more than 100uS. The RS232 transceiver will wake up when valid input is detected again.

By default, the RS232 transceiver is put in AUTO-ONLINE. This mode can be turned off by issuing AT+WIOM=,16.

CHAPTER 6 TROUBLESHOOTING

6.1 The modem's LED does not light :

Check if the modem has connected to a 5-32V power supply properly

Check if the power connector is properly inserted

Check the fuse on the power cord

6.2 The modem's LED lights but does not blink long time after power up

Check if a valid SIM card has been inserted properly

Check if the SIM card has been locked (refer to AT+CPIN command in AT command guide)

Check if the external has been connected properly to the modem

Check if the network coverage is available.

6.3 The modem does not response to the terminal program

Check if the RS-232 cable has been connected properly

Check if your program has proper setting. Factory setting of the modem is:

115200bps (9600bps for Maestro 100 Eco)

8 data bits

no parity bit

1 stop bit

6.4 No voice could be heard for the modem's speaker output when a call is answered

Make sure a voice call has been made (refer to AT command guide)

Enter the AT+SPEAKER=1 command

For more information or general enquiries:

R F Solutions Ltd.

Unit 21, Cliffe Industrial Estate,

South Street, Lewes, BN8 6JL, England.

Email: sales@rfsolutions.co.uk Web: <http://www.rfsolutions.co.uk>

Tel: +44 (0)1273 898 000 Fax: +44 (0)1273 480 661