

SECURITY ALARMS

- 479-743

AD11
AD01

SECURITY AUTODIALLER

Cat. No. AD11

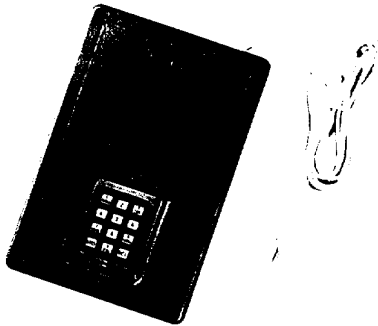

TRADE ONLY

The Smiths Security Autodialler will automatically dial up to six pre-programmed telephone numbers to alert neighbours, family, friends or colleagues. It continues to dial these numbers until one is answered and then relays a spoken emergency message giving the telephone number where the alarm has originated. A return call from the recipient confirms the emergency has been acknowledged and further dialling will cease. The recipient can now take whatever action has been previously agreed, or seems necessary. The Security Autodialler works on a normal BT line in conjunction with any siren-only alarm system. Easy to set, it has speech recall to ensure correct programming. Designed for internal use (both in domestic and commercial situations) it is connected to the BT line by an existing BT approved master or extension telephone socket.

FEATURES • Approved for connection to telecommunication systems

- Automatically alerts neighbours, family or friends to a break-in at your home or business premises
- Continually dials up to 6 pre-programmed telephone numbers until it receives a positive response
- Transmits a spoken emergency message giving the telephone number where the alarm has originated
- Alarm inputs suitable for Wireless Alarm Systems (SAS12), Air Activated Alarm System (SAS02), PIR and other wired detectors and alarm panel connection
- Output for External Strobe/Siren connection (ESS02)

SPECIFICATION **Dialler voltage** 4.5V DC 3 x AA size batteries (not supplied) **Alarm voltage** 3.0V DC 2 x AA size batteries (not supplied) **REN 1** (3 additional telephones also with a REN of 1 may be used with the Autodialler) **Alarm inputs** Single channel normally closed inputs. Minimum loop current μ A.

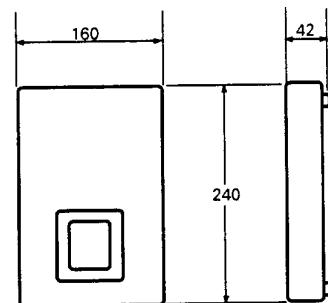

EMERGENCY AUTODIALLER

Cat. No. AD02

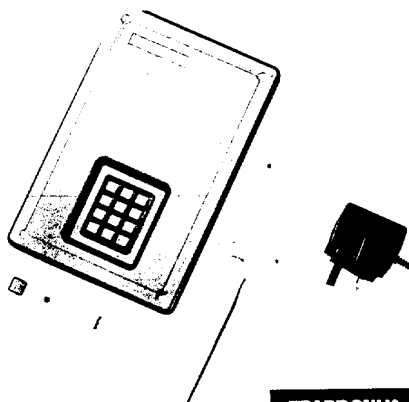

TRADE ONLY

A telephone emergency system which automatically dials up to six pre-programmed numbers to alert neighbours, family or friends that a home emergency has taken place (a fall for instance, rendering the occupant unable to reach the telephone). It continues to dial those numbers until one is answered and then it will then relay a spoken Emergency message giving the telephone number where the emergency has originated. A return call from the recipient confirms the message has been acknowledged and further dialling will cease. The recipient can now take whatever action has been previously agreed, or seems necessary. The Emergency Autodialler works on a normal BT line in conjunction with a push button radio transmitter (up to 30 metre signal range) and receiver with power-on indicator. Easy to set, it has speech recall to ensure correct programming. Designed for internal use it is connected to the BT line by

an existing BT approved master or extension telephone socket.

FEATURES • Approved for connection to telecommunication systems • Automatically alerts neighbours, family or friends to an emergency at home • Continually dials up to 6 pre-programmed telephone numbers until it receives a positive response • Transmits a spoken emergency message giving the telephone number where the emergency has originated.

SPECIFICATION **Dialler voltage** 4.5V DC 3 x AA size batteries (not supplied) **Alarm voltage** 3V DC 2 x AA size batteries (not supplied) **REN 1** (3 additional telephones also with a REN of 1 may be used with the Autodialler) **RF transmitter voltage** 9V DC 1 x PP3 battery (not supplied) **RF receiver** Power supply – via AC/DC mains adaptor (supplied) **Frequency** 418 MHz

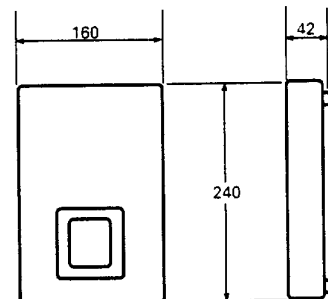

479-743



SECURITY AUTODIALLER

AD01

INSTALLATION AND USER INSTRUCTION MANUAL

APPROVED for connection to telecommunications systems specified in the instructions for use subject to the conditions set out in them.

S/2085/3/L/502019

REN1

THIS MANUAL SHOULD BE KEPT IN A SAFE PLACE FOR FUTURE REFERENCE.

SECURITY AUTODIALLER

CAT.NO. AD01

Appendix I

PROGRAMMING INSTRUCTIONS TO SET ENTRY DELAY TO ZERO SECONDS

PLEASE READ THE FOLLOWING INSTRUCTIONS BEFORE PROGRAMMING AUTODIALLER

Security Autodialler has been factory programmed to a 40 second entry delay time (refer to section 4.5).

Where an alarm system is already installed with its own entry delay time, you have the option on Autodialler to change the factory set programme from 40 seconds to zero seconds entry delay time. (Refer to Appendix II for wiring configuration.)

The entry delay time on Autodialler can be programmed to zero seconds at any time prior to arming the unit (refer to section 4.1). However, we recommend you programme zero seconds before programming your PIN, HTN, Emergency Telephone Numbers and SEQ codes (refer to sections 3.2, 3.3, 3.4 and 3.5).

NOTE: Autodialler's alarm and dialler batteries must be inserted before programming (refer to section 2.0).

To programme Autodialler to zero seconds entry delay:-

PRESS KEY	<input type="text" value="STO"/>	(Bleep)
PRESS KEY	<input type="text" value="8"/>	(Bleep)
PRESS KEY	<input type="text" value="3"/> <input type="text" value="DIS"/>	(Bleep)
PRESS KEY	<input type="text" value="0"/> <input type="text" value="PIN"/>	(Bleep)
PRESS KEY	<input type="text" value="STO"/>	(Bleeeeeep)

The long bleep acknowledges entry delay is now set to zero seconds.

To revert back to the factory set 40 seconds delay, first unplug the connection to the BT network, remove the 3 x AA size dialler batteries for a few seconds (refer to section 2.0), then reconnect. Reprogramme your PIN, HTN, Emergency Telephone Numbers and SEQ codes in accordance with the programming instructions.

SECURITY AUTODIALLER CAT.NO. AD01

Appendix II

CONNECTING A P.I.R, OTHER SENSOR OR ALARM PANEL TO AUTODIALLER

Security Autodialler has one sensor input (marked 1 and 2), see Figure 3 on user guide. Normally this sensor input is wired in series with pairs of magnetic contacts. When the series connection is broken (i.e open circuit) Autodialler goes into alarm mode.

1. To connect a P.I.R. sensor to Autodialler:-

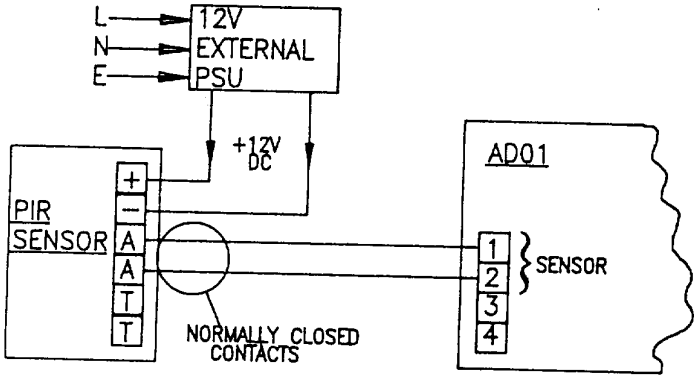

Fig1 PIR CONNECTION TO AD01

2. To connect Autodialler to a full alarm system:-

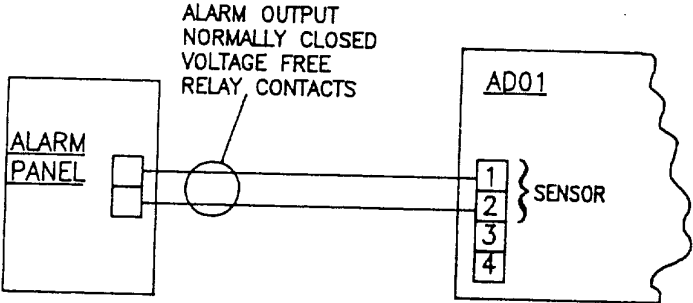

Fig2 ALARM PANEL CONNECTION TO AD01

Refer to Appendix I if zero seconds entry delay time is required.

PLEASE NOTE:- DO NOT USE ALARM CONTACTS 3 AND 4.

SMITHS SECURITY AUTODIALLER

INSTRUCTION MANUAL

PLEASE READ THIS THOROUGHLY. YOUR AUTODIALLER IS FOR USE IN EMERGENCIES. IT IS IMPORTANT IT IS PROPERLY INSTALLED AND YOU UNDERSTAND HOW IT WORKS.

Contents

SECTION	DESCRIPTION	PAGE
1.0	General	3
2.0	Power Supply	4
3.0	Alarm Inputs	5
3.1	Setting Up Procedure	6
3.2	Programme/Recall PIN	6
3.3	Programme/Recall Home Telephone Number	7
3.4	Programme Emergency Telephone Numbers	8
3.5	Programming SEQ	10
4.0	Operating Instructions	11
5.0	Emergency Procedure	14
5.1	Test Dial	15
6.0	Trouble Shooting	15
7.0	Conditions of Use	17
8.0	Technical Specifications	18
9.0	Quick Step Instructions	20

SMITHS SECURITY AUTODIALLER

INSTALLATION AND OPERATING INSTRUCTIONS

1.0 GENERAL

Autodialler will automatically alert your neighbours, family, friends or colleagues to a break-in at your home or business premises when you are out so that appropriate action can be taken.

Autodialler continually dials up to six pre-programmed telephone numbers until it receives a positive response and knows that your emergency is being dealt with.

This innovative security system works on a normal British Telecom line; all you need to set up the Autodialler are five standard AA batteries. It is easy to install and use, and full instructions are given in the following pages.

The Autodialler is intended for internal use within domestic and industrial environments. It should be connected to the British Telecom line via an existing British Telecom approved master or extension telephone socket. (If your premises have not been converted to the modern telephone plug socket arrangement you should inform British Telecom who will convert your telephone line for a nominal charge). Notify British Telecom by completing the request slip on the centre page of this manual.

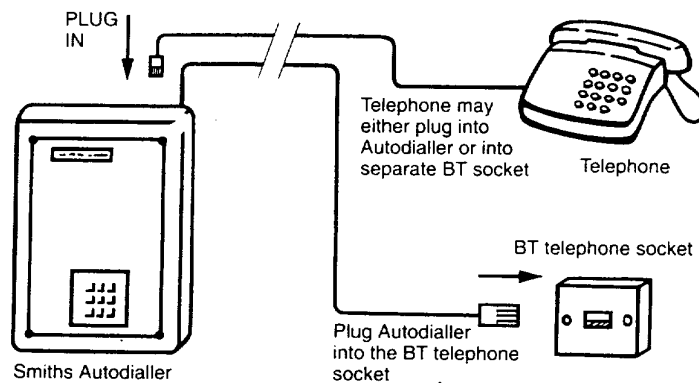

FIGURE 1. Autodialler Installation

During the dialling out sequence, Autodialler has been designed to detect the following tones: dial, ring, engaged and unobtainable. If a telephone number that Autodialler has dialled is engaged or unobtainable, then Autodialler will continue to dial the next number in the sequence.

Autodialler will transmit the spoken emergency message giving details of the telephone number where the alarm has originated. The emergency message will be repeated three times, allowing the recipient time to note the origin of the emergency. Having sent the emergency message the Autodialler will disconnect the call and wait three minutes for a reply. If a telephone call is received within the three minutes, the Autodialler will recognise that the emergency message has been received by an authorised guardian

and will stop further dialling. If however, no return call is received, it continues dialling until it receives a reply.

When a reply has been received, the Autodialler has completed its function and informed an authorised guardian that there is an emergency "at home". The responsibility lies with that person to take whatever action has been previously agreed, or seems appropriate.

Autodialler is ideally suited for table top placement with the telephone placed directly on top of the unit. Two keyhole slots have also been provided on the back of the unit for wall mounting.

2.0 POWER SUPPLY

The Autodialler is battery powered to allow the system to work in the event of mains failure. **UNPLUG THE CONNECTION TO THE BT NETWORK BEFORE OPENING EITHER OF THE BATTERY COVERS.** Remove the battery covers on the back of the unit and insert three AA batteries into the compartment marked "Batteries for Dialler" and two AA batteries into the compartment marked "Batteries for Alarms". Make sure you insert the batteries the correct way round with the positive ends of the batteries (+) going to the positive ends of the compartment (+).

Three batteries power the memory and dialling circuits of the Autodialler and the two batteries power the alarm contacts. For details of the alarm contacts refer to section 3.0.

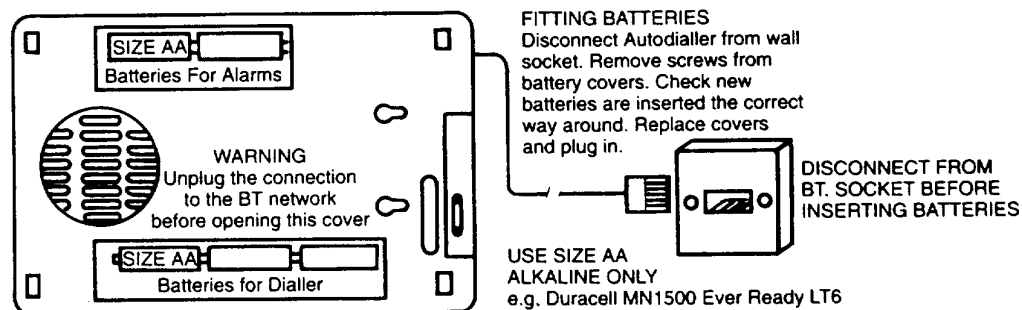

FIGURE 2. Fitting the Batteries

Under normal usage the batteries should last for at least twelve (12) months.

2.1 LOW BATTERY WARNING

Dialler Battery Warning

After initially inserting the three batteries if a long bleep lasting eight seconds is heard then please use new batteries.

If the batteries are getting too low, the Autodialler will emit a short bleep approximately every ten minutes. It is recommended that the batteries are replaced immediately the low battery warning is heard. In normal use if the Autodialler will not acknowledge any commands it means the batteries are flat.

Alarm Batteries

For batteries providing power to the magnetic contacts, Autodialler will inform the user that either an alarm condition is present or the batteries are flat when Autodialler is armed. See section 4.3.

3.0 ALARM INPUTS

Autodialler will monitor normally closed alarm circuits. Provided with Autodialler are 2 pairs of magnetic contacts. These should be wired to terminals 1 and 2 of Autodialler as shown below.

The magnetic contacts should be accurately aligned with a gap not exceeding 5 mm when the door or window is closed. The magnet should be mounted on the moving part (ie the door or window) with the switch contact on the frame. The magnet and contact should be mounted away from the hinges to allow maximum movement apart. Secure doors or windows most likely to be activated by an intruder – these may include interior doors.

All door/window contacts should be wired in "series" (ie looped from one set of contacts to another and then back finally to Autodialler). If at a later stage you wish to add more magnetic contacts to your system you MUST remove "LINK A" so that the only connections are between Autodialler and the first and last magnetic contacts – the rest being "looped" together. If you wish to extend your security system with more magnetic contacts please complete the order form on the centre page of this manual. Additional bell cable can be purchased from most electrical shops.

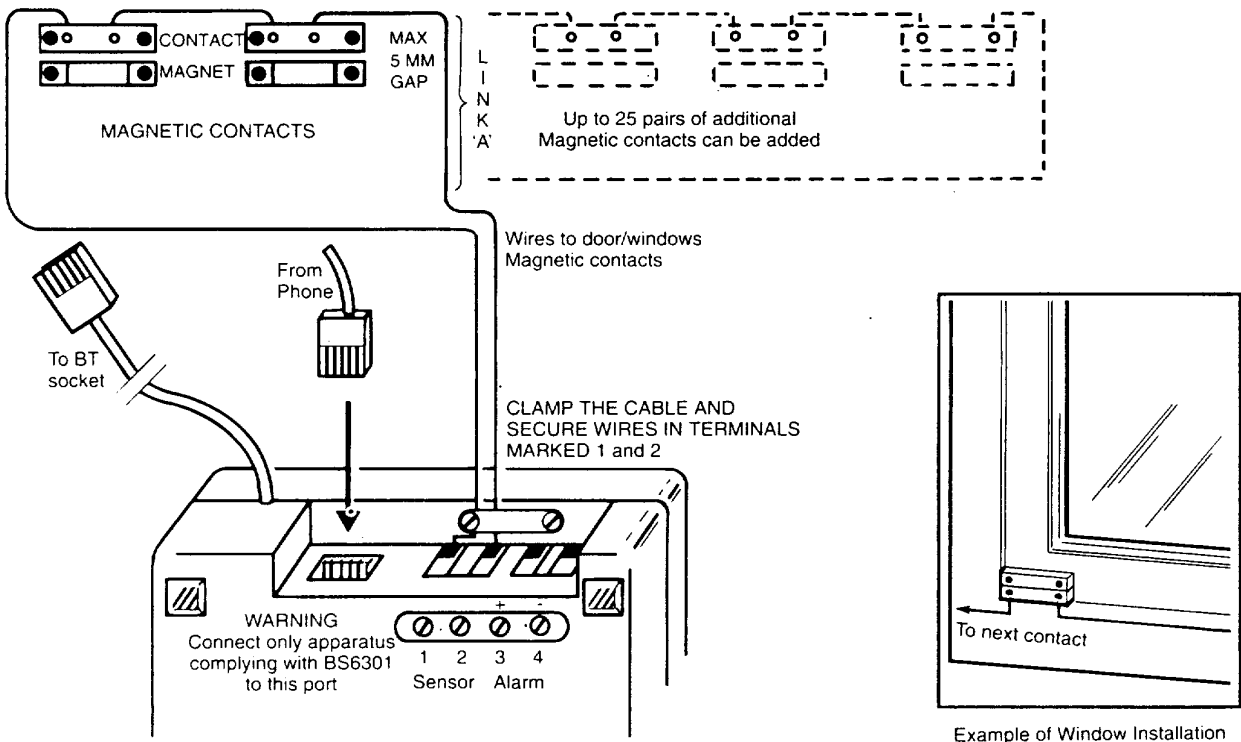

FIGURE 3. Installing the Magnetic Door/Window contacts

3.1 SETTING UP PROCEDURE

Autodialler requires certain information to be entered for the setting up procedure. Autodialler requires a Personal Identification Number (PIN), your home telephone number (HTN), and at least one emergency telephone number.

Operating Modes

Autodialler has two operating modes:-

1. Sleep mode:- this is the normal mode Autodialler is in. In this mode Autodialler waits for your command from the keyboard. A speaker is provided for checking programmed numbers. Autodialler will say "error" if an invalid command is entered or the keys are pressed in the wrong order. Short bleeps indicate acceptance of commands.

NOTE:- Autodialler has an auto power off feature, i.e. if no key is pressed within 20 seconds then the Autodialler goes into sleep mode to save power. So if you leave a partly finished command for more than 20 seconds then you have to retype in the same command again.

2. Arm mode:- This mode is activated by typing in ARM instructions. Once armed Autodialler will monitor alarm inputs and commence emergency dialling should it be necessary.

3.2 TO PROGRAMME YOUR PERSONAL IDENTIFICATION NUMBER (PIN)

Your PIN must have two digits. Choose any number which you can remember very easily. Listed below are the steps for programming your PIN.

Press key: STO PIN P1 P2 STO

where P1, P2 are the two digits of your PIN. (i.e. numbers between 0 and 9).

Example 1

Lets say the PIN you have chosen is 32.

- | | | | |
|----|-----------|-----|-----------------------------------|
| 1. | press key | STO | start programme mode |
| 2. | press key | PIN | Pin number about to be programmed |
| 3. | press key | 3 | P1 |
| 4. | press key | 2 | P2 |
| 5. | press key | STO | end programme mode |

CHECK OR RECALL PIN

Press keys: RCL PIN. Your PIN number will be heard via the built in speaker (three, two).

NOTE: If your PIN has not been programmed correctly by following the steps in Example 1, then the Autodialler will respond by saying "error".

3.3 TO PROGRAMME YOUR HOME TELEPHONE NUMBER (HTN)

HTN forms part of the emergency message and it enables the authorised guardians to identify where there is an emergency. Listed below are the steps for programming HTN:-

Press keys: STO HTN n1 n2 n3 n4 n5 n6 n7 ----- n12 STO

where n1 to n12 are telephone number digits.

Note: HTN must be between 4 to 12 digits.
You DO NOT have to use all twelve digits.

Example 2

Lets say the HTN to be programmed is 0123 4567

1. Press key STO start programme mode
2. Press key HTN HTN about to be programmed
3. Press key 0 } n1
4. Press key 1 } n2
5. Press key 2 } n3
6. Press key 3 } n4
7. Press key 4 } n5
8. Press key 5 } n6
9. Press key 6 } n7
10. Press key 7 } n8
11. Press key STO end programme mode

CHECK OR RECALL HOME TELEPHONE NUMBER (HTN)

The stored HTN is recalled by pressing the following keys:

1. Press key RCL
2. Press key HTN. Your HTN is heard via the speaker. (zero, one, two, three, four, five, six, seven).

NOTE: If your HTN has not been stored, then the Autodialler will respond by saying "error" as you are attempting to call a non-existent HTN. Go back to example 2 and ensure you enter your HTN correctly.

3.4 TO PROGRAMME YOUR EMERGENCY TELEPHONE NUMBERS

These telephone numbers should be your authorised guardians (neighbours, family, friends, colleagues and/or authorised keyholders) and forms part of the emergency message. A maximum of six telephone numbers can be programmed into the Autodialler memories. These numbers should be entered in the order you wish them dialled in an emergency.

IMPORTANT: THE EMERGENCY TELEPHONE NUMBERS YOU WISH TO DIAL IN AN EMERGENCY ARE STORED IN AUTODIALLER'S MEMORIES. AUTODIALLER HAS SIX MEMORIES (m = 1 to m = 6) IN WHICH THE EMERGENCY TELEPHONE NUMBERS ARE STORED. WHEN PROGRAMMING YOUR EMERGENCY TELEPHONE NUMBERS INTO AUTODIALLER YOU MUST REMEMBER TO ALLOCATE A DIFFERENT MEMORY NUMBER (m) TO EACH TELEPHONE NUMBER ENTERED.

Listed below are the steps for programming your emergency telephone numbers:

STO m n1 n2 n3 n4 n5 n6 n7 ----- n12 STO

Where m is the Autodialler memory number where the emergency telephone number is stored. There are six emergency telephone number memories 1 to 6 (m must be a number between 1 and 6).

Where n1 to n12 are telephone number digits and these must be between 4 to 12 digits long.

Example 3

Lets say the emergency telephone number to be programmed is "0123 45678" in emergency telephone number memory 1.

- | | | | |
|-----|-----------|-----|--|
| 1. | Press key | STO | start programme mode |
| 2. | Press key | 1 | emergency telephone number stored in memory No. 1. (m=1) |
| 3. | Press key | 0 | n1 } |
| 4. | Press key | 1 | n2 } Desired |
| 5. | Press key | 2 | n3 } telephone |
| 6. | Press key | 3 | n4 } number |
| 7. | Press key | 4 | n5 } 0123 45678 |
| 8. | Press key | 5 | n6 } to be stored in |
| 9. | Press key | 6 | n7 } memory number 1 |
| 10. | Press key | 7 | n8 } |
| 11. | Press key | 8 | n9 } |
| 12. | Press key | STO | end programme mode |

CHECK OR RECALL EMERGENCY TELEPHONE NUMBER

The stored emergency telephone number is recalled by pressing the following keys:

1. Press key RCL
2. Enter Memory Number (m) (number between 1 to 6)

NOTE: If there is no emergency number stored in the memory recalled (m) Autodialler will respond by saying "error" as you are attempting to recall the number from an empty memory. Go back and make sure you are entering the emergency numbers correctly. Remember to allocate a different memory number for each different emergency number (m=1 to 6).

TO PROGRAMME THE REST OF YOUR EMERGENCY TELEPHONE NUMBERS

Repeat the steps shown in Example 3 to store other emergency telephone numbers. Remember to use different emergency telephone number memories (m numbers 1 to 6) for each new emergency telephone number to be stored.

Autodialler will automatically dial the emergency telephone numbers in memory order, i.e. the number in Memory 1 followed by Memory 2 etc. (dial m=1 followed by m=2 etc.). YOU DO NOT HAVE TO USE ALL SIX MEMORIES

NOTE: If you wish to change an emergency telephone number, simply programme the new number into the desired memory (m) as shown in Example 3. This will automatically delete the old number stored in that memory and replace it with the new number.

It is advisable to write down your emergency numbers for reference even though you can ask Autodialler to recall any number stored. Below is a handy chart for your use.

TABLE 1

Emergency Telephone Numbers		
Autodialler Memory Number (m)	Emergency Telephone Number	Name of Guardian
1		
2		
3		
4		
5		
6		

YOU HAVE NOW FINISHED ENTERING THE INFORMATION REQUIRED FOR THE SETTING UP PROCEDURE.

3.5 TO PROGRAMME YOUR OWN EMERGENCY DIALLING SEQUENCE (SEQ)

SEQ determines the dialling sequence. If you do not want Autodialler to dial out in order m=1, m=2, m=3 etc. (see Section 3.4) you may have your own SEQ. The advantage of having this feature is once the telephone numbers are stored in Autodialler's memory (m=1 to m=6) you can select only the ones for neighbours, family, friends and colleagues and/or authorised keyholders you know are available for the sequence (SEQ).

NOTE: You can change your desired SEQ as often as you like. You do not have to use all six numbers. Autodialler will remember the last SEQ entered and always dial in that SEQ until a new SEQ is entered.

Below are the steps to programme the dialling sequence:-

Press keys : STO SEQ m, m, m, etc. STO
Where m=1 to m=6 are the emergency telephone memories

Example 4

Lets say there are five different emergency telephone numbers stored in Autodialler emergency telephone memories No. m=1, No. m=2, No. m=3, No. m=4 and No. m=5 and they are:

TABLE 2

Emergency Telephone Numbers		
Autodialler Memory Number (m)	Emergency Telephone Number	Name of Guardian
1	0123	Ron Reliable
2	01234	Fiona Friend
3	012345	Neil Neighbour
4	0123456	Helen Honesty
5	01234567	Tom Trustworthy

Lets say Ron, Fiona and Helen are sometimes not available (e.g. on holiday). You want to ring Neil first and then Tom. Listed below are the steps for programming this dialling sequence (SEQ):

1. press key STO start programme mode
2. press key SEQ programme SEQ
3. press key 3 } first dial Neil (telephone number in memory 3)
4. press key 5 } second dial Tom (telephone number in memory 5)
5. press key STO end programme mode

CHECK OR RECALL EMERGENCY DIALLING SEQUENCE (SEQ)

Stored SEQ is recalled by pressing following keys:

RCL SEQ Sequence number(s) are heard via the built in speaker (in Example 4 – three, five). NOTE: If a sequence (SEQ) has not been programmed, the Autodialler will respond by the factory set SEQ (one, two, three, four, five, six). Only the memory numbers which have emergency tel. no's entered into them will be announced.

NOTE: You can change your desired emergency dialling sequence (SEQ) as often as you like. You may have one sequence you prefer when you are out during the day and another for an evening out etc.

4.0 OPERATING INSTRUCTIONS

Having followed all the installation instructions in sections 2 & 3 you are now ready to use the Autodialler. To operate (ARM) the Autodialler you must have already programmed in your PIN, your own telephone number (HTN), and at least one emergency telephone number. If you have not programmed in all of the above items go back to the relevant sections and do so now.

4.1 ARMING (ACTIVATING) AUTODIALLER

Before arming Autodialler make sure all doors and windows are closed and that no alarm input is activated.

Your PIN number is used to arm Autodialler. The following steps show how to ARM your Autodialler.

Press keys: ARM P1 P2

Where P1 P2 are your PIN number digits

After pressing the last digit, Autodialler should immediately respond by bleeping four times.

BLEEP .. BLEEP .. BLEEP .. BLEEP

BRITISH TELECOM SOCKET CONVERSION REQUEST

If your premises have not been converted to the modern telephone plug socket arrangement you should inform British Telecom by completing the following request slip who will convert your telephone line for a nominal charge.

TO: British Telecom

I am now the owner of a Smiths Security Autodialler

Model..... AD01

Approval Number..... S/2085/3/L/502019

Please come and fit extension sockets for me as soon as possible.

Name

Address

.....

.....

Telephone No:.....

Date:..... Signed:

Please complete and send to your local British Telecom sales office. Refer to your area telephone directory for address.

DOOR/WINDOW MAGNETIC CONTACTS ORDER FORM

I wish to extend my Security Autodialler security system.
Please send:



No of Contacts pairs

Name

Address

.....

.....

.....

Tel. No.



Magnetic contacts are supplied in pairs.

Price **£0.60** / pair (incl of VAT) plus **£0.50 P & P**.
(Cheques should be made payable to Smiths Industries PLC)

Allow 10-14 days delivery

(Bell cable cannot be supplied – available from most
electrical shops)

I enclose a cheque for £..... covering this order.

Send to: Smiths Industries Environmental Controls Co Ltd.
Apsley Way (off Waterloo Road), London NW2 7UR

DOOR/WINDOW MAGNETIC CONTACTS ORDER FORM

I wish to extend my Security Autodialler security system.
Please send:



No of Contacts pairs

Name

Address

.....

.....

.....

Tel. No.



Magnetic contacts are supplied in pairs.

Price **£0.60** / pair (incl of VAT) plus **£0.50 P & P**.
(Cheques should be made payable to Smiths Industries PLC)

Allow 10-14 days delivery

(Bell cable cannot be supplied – available from most
electrical shops)

I enclose a cheque for £..... covering this order.

Send to: Smiths Industries Environmental Controls Co Ltd.
Apsley Way (off Waterloo Road), London NW2 7UR

AUTHORISED GUARDIAN NOTIFICATION SLIP

Dear

Thank you for becoming one of my Authorised Guardians.

Autodialler will automatically alert you if an intruder breaks into my home/business premises (delete as appropriate) allowing you to take the appropriate action.

Autodialler will dial up to 6 pre-programmed telephone numbers, one of which is yours, until it gets a positive response and knows that the emergency is being dealt with.

If a break-in occurs you will receive a telephone call relaying the following message:

THIS IS AUTODIALLER ON (my home telephone number) calling (your telephone number).

THERE IS AN EMERGENCY – PLEASE ACKNOWLEDGE
(message repeated 3 times).

After the third repetition you must put the phone down and immediately ring back my home telephone number

Autodialler will wait 3 minutes for this call back before dialling another emergency number.

Upon receipt of your call back Autodialler will give the following spoken acknowledgement to you:

AUTODIALLER ACKNOWLEDGE ON (my home telephone number) (message repeated 3 times)

Autodialler now knows the emergency is being dealt with.

IT IS NOW UP TO YOU AS MY AUTHORISED GUARDIAN TO TAKE WHATEVER ACTION HAS BEEN PREVIOUSLY AGREED, OR SEEMS APPROPRIATE.

Thank you.

AUTHORISED GUARDIAN NOTIFICATION SLIP

Dear

Thank you for becoming one of my Authorised Guardians.

Autodialler will automatically alert you if an intruder breaks into my home/business premises (delete as appropriate) allowing you to take the appropriate action.

Autodialler will dial up to 6 pre-programmed telephone numbers, one of which is yours, until it gets a positive response and knows that the emergency is being dealt with.

If a break-in occurs you will receive a telephone call relaying the following message:

THIS IS AUTODIALLER ON (my home telephone number) calling (your telephone number).

THERE IS AN EMERGENCY – PLEASE ACKNOWLEDGE
(message repeated 3 times).

After the third repetition you must put the phone down and immediately ring back my home telephone number

Autodialler will wait 3 minutes for this call back before dialling another emergency number.

Upon receipt of your call back Autodialler will give the following spoken acknowledgement to you:

AUTODIALLER ACKNOWLEDGE ON (my home telephone number) (message repeated 3 times)

Autodialler now knows the emergency is being dealt with.

IT IS NOW UP TO YOU AS MY AUTHORISED GUARDIAN TO
TAKE WHATEVER ACTION YOU DEEM NECESSARY.

Thank you.

Now you have 40 seconds to leave the premises.

If you wish Autodialler can be DISARMED during this period. (See Section 4.4).

After 40 seconds have elapsed, Autodialler responds by a further four louder beeps.

BLEEP .. BLEEP .. BLEEP .. BLEEP

Autodialler is now in ARM mode.

If having pressed ARM followed by your PIN you do not hear the 4 beeps but instead hear "error" Autodialler has not accepted the command.

Check the following:

- (i) You have keyed in the correct PIN code.
- (ii) The emergency telephone number(s) have been entered into Autodialler's emergency telephone number memories correctly.
- (iii) You have remembered to programme in your own home telephone number (HTN).
- (iv) If you have entered a SEQ (See Section 3.5) that you have emergency telephone numbers in ALL the memories listed in your SEQ.

WARNING: Before ARMING Autodialler ensure all emergency telephone numbers are correctly programmed.

4.2 EXIT DELAY – 40 Seconds

Please note: After arming Autodialler there is an automatic exit delay of 40 seconds to allow you to leave the premises without activating Autodialler.

4.3 ALARM CONDITIONS

A. If an alarm condition is present (i.e. door or window open) when Autodialler is Armed, Autodialler will say "Check System, Check System" and return to sleep mode (disarm itself). It will not sound the 4 arming beeps. Make sure all security wired windows and doors are closed, and the magnetic contacts are fitted properly. If all alarm contacts seem OK and not in a position to register an alarm, check that the 2 batteries for the alarm contacts are fitted correctly and are not run down. Now return to Section 4.1 and Arm Autodialler once more.

B. If an alarm is activated during the exit delay, after the 4 Arming Beeps, Autodialler will sound an intermittant series of short beeps for 4 seconds.

- (i) As long as the alarm condition is cancelled (i.e. door or window shut) before the 40 second exit delay time has elapsed, Autodialler will sound the second set of 4 beeps and will be in ARM mode.

- (ii) If the alarm condition is still present at the end of the exit delay period, Autodialler will say "Check System" and sound a single long bleep (4 seconds) and return to sleep mode (disarm itself). It will now be necessary for you to carry out the Arming process in Section 4.1 to Arm Autodialler once more.

THE AUTODIALLER CANNOT GO INTO ALARM MODE IF THERE IS AN ALARM PRESENT AT THE END OF THE EXIT DELAY TIME.

4.4 DISARMING THE AUTODIALLER

Autodialler can be disarmed at any time by following the disarming procedure. Your PIN number is used to disarm Autodialler.

Follow these steps for disarming:

(Autodialler is in arm mode)
Press keys DIS P1 P2

Where P1, P2 are your PIN number digits.
(after pressing the last digit, Autodialler should respond as follows)

(A) BLEEP .. BLEEP .. BLEEP .. BLEEP

Autodialler has now disarmed and returned to Sleep Mode. **No emergency occurred during the Armed period.**

(B) "EmergencyEmergency" "BLEEP, BLEEP....BLEEP....BLEEP".

Autodialler has now disarmed but has made emergency calls during the armed period. Check with your authorised guardians to find out who received the call and what action was taken.

Trouble Shooting After Disarming the Autodialler

(i) "Error" – After pressing P1 or P2

If the Autodialler does not bleep four times after keying in the digits of PIN but instead says "error" then you have made a mistake (probably used an incorrect PIN).

Repeat the disarm (DIS) sequence.

(ii) "Error" – After pressing DIS key only

If Autodialler says "error" immediately, Autodialler was already disarmed and it is already in Sleep Mode.

(a) Either Autodialler was not Armed correctly,

- (b) or Autodialler registered an alarm at the end of the Exit delay, and automatically disarmed itself (See Section 4.3),
- (c) or someone has already disarmed Autodialler.

4.5 ENTRY DELAY

When Autodialler is in Armed mode, upon entering a protected zone the user has 40 seconds in which to disarm the Autodialler.

If Autodialler is not disarmed during the 40 seconds entry delay time, it will then quietly begin to dial the emergency telephone numbers.

If you have entered your premises, and forgotten to disarm Autodialler, probably the first you will know of your lapse will be your phone ringing. Your phone will ring for 5 seconds before being answered by Autodialler. (This will be an authorised guardian acknowledging receipt of the emergency call from Autodialler). **IT IS IMPORTANT YOU PICK UP THIS CALL AND INFORM THAT PERSON THAT IT WAS A FALSE ALARM TO STOP THEM MAKING AN UNNECESSARY VISIT TO YOUR PREMISES OR TAKING WHATEVER ACTION HAS BEEN PREVIOUSLY AGREED.** The Autodialler will still pick up the call to acknowledge its message has been received, so you will hear it talking over your conversation.

5.0 EMERGENCY PROCEDURE

Once Armed, if Autodialler detects an alarm condition (i.e. door or window open) it will start dialling the emergency numbers if it is not disarmed within the 40 seconds entry delay time. Autodialler will always allow 30 seconds for its calls to be answered before assuming the guardian is out and dialling the next number.

The emergency message consists of the following text:

THIS IS AUTODIALLER ON – (HTN) – CALLING – (emergency telephone number)
THERE IS AN EMERGENCY, PLEASE ACKNOWLEDGE.

This message is repeated three times to allow the recipient (your authorised guardian) to note the origin of the message, i.e. where the call is coming from. This is determined by your Home Telephone Number (HTN) which forms part of the message. It is very important that your Authorised Guardians are aware that Autodialler may call them in an emergency. ***Please fill in the "Authorised Guardian notification slips" (supplied on the centre page of this manual) and give one to each of your chosen Authorised Guardians.***

The Authorised Guardian **MUST** phone your home telephone number (HTN) immediately the Autodialler has finished the third repetition of the emergency message. Autodialler will wait three minutes for the return call. Upon receipt of the call back Autodialler will give this spoken acknowledgement to the Authorised Guardian:

AUTODIALLER ACKNOWLEDGE ON – (HTN) – (This is repeated three times.)
After Autodialler has received the phone call Autodialler has completed its function and informed an authorised Guardian of the emergency "at home". Autodialler will stop further dialling.

NOTE: When testing Autodialler please remember to inform the recipient of the emergency call and that it is a test only and not a real emergency.

The recipient should still phone back your telephone number to acknowledge or Autodialler will assume the emergency message has not been received and will dial the next emergency telephone number.

5.1 TEST DIAL

We recommend you carry out a test dial to each of your Authorised Guardians to familiarise them with the emergency call procedure. Arm Autodialler and then open a protected door or window.

When testing the system please ask the Authorised Guardian to let the phone complete 2 cycles of ring tone before answering – as would happen in normal usage (i.e. Brrring BrrringBrrring Brrring.....).

This ensures Autodialler will hear the ring tone and prepare to speak. In the unlikely event of Autodialler not hearing the ring tone – don't worry, it will merely assume no connection was made and continue dialling.

When testing it is most convenient to test one Authorised Guardian at a time. Either use SEQ as detailed in Section 3.5 or programme each emergency number in turn into memory 1 (m=1). See Section 3.4.

6.0 TROUBLE SHOOTING

Arming Autodialler

If after arming instructions you hear 4 bleeps followed by 40 seconds silence then another 4 bleeps – THIS IS CORRECT. Autodialler is now armed. The 40 second delay allows you time to leave the premises.

If "error", "Check System" or intermittent short bleeps are heard refer to Sections 4.1 and 4.3.

Disarming Autodialler

If after disarming instructions you hear 4 bleeps – THIS IS CORRECT. Autodialler is now disarmed. If you hear "error" refer to Section 4.4.

SUMMARY TROUBLE SHOOTING TABLE

Fault	Symptom	Remedy
1. Autodialler will not accept any command	Silence	Check batteries are in the correct way round. See Section 2.
2. Autodialler will not accept PIN	"Error"	Check you are programming correctly. See Section 3.2.
3. Autodialler will not accept HTN	"Error"	Check you are programming correctly. See Section 3.3.
4. Autodialler will not accept Emergency Telephone Numbers	"Error"	Check you are programming correctly. See Section 3.4. NOTE: You must allocate a memory number between 1 and 6 (m) before keying in the emergency telephone number.
5. Autodialler recalls wrong emergency telephone number	Wrong telephone number heard through Speaker	Check you are programming correctly. See Section 3.4. Use Table 1, Section 3.4 to help.
6. Autodialler will not accept SEQ	"Error"	Check you are programming correctly. See Section 3.5.
7. Autodialler will not arm	"Error"	Ensure you have entered PIN, HTN, Emergency Telephone Numbers and SEQ correctly. See Sections 3.2, 3.3, 3.4, 3.5. Ensure you are programming correctly with correct PIN, See Section 4.1.
8. Autodialler will not arm	"Check System"	One or more alarm contacts are registering an alarm condition. See Section 4.3.
9. Autodialler detects alarm during exit delay	Intermittant. Bleeps (4 seconds).	One or more alarm contacts are "open" during exit delay. See Section 4.3.
10. Autodialler will not dial out	Authorised guardian does not receive the call	Make sure unit is plugged into BT phone socket. Make sure the correct emergency telephone number is stored in the memory number (m) you are attempting to dial.
11. After disarming Autodialler error is heard	"Error"	Ensure you have entered your PIN correctly. See Section 4.4. Autodialler was already disarmed and in Sleep Mode. See Section 4.4.

HELP LINE

If you are experiencing problems in operating your Security Autodialler, please ring our Technical Service Department on 081-450 8944.

7.0 CONDITIONS OF USE

Autodialler may be connected to the following types of installation.

- (a) business and domestic direct exchange lines (PSTN) employing loop disconnect and tone (MF) dialling.
- (b) extensions with new plug and socket arrangements.

This apparatus has been approved for the use of the following facilities:-

- auto calling (emergency only)
- series connection (for main apparatus)
- auto answer

Refer to Section 1.0 for the description of the facilities provided by the Autodialler.

Any other usage will invalidate the approval of the apparatus if, as a result it then ceases to comply with the standards against which approval has been granted.

Interconnection directly, or by way of other apparatus, of ports marked.

(WARNING: connect only apparatus complying with BS6301 to this port) with ports not so marked may produce hazardous conditions on the BT network and that advice should be obtained from a competent engineer before such a connection is made.

NOTE: Autodialler must be disarmed if you intend to use main apparatus or other parallel connected apparatus. Autodialler may not dial/transmit if the main or any parallel connected apparatus is being used.

The Autodialler **SHOULD NOT** be connected to the following installations

- (a) as an extension to a payphone
- (b) as an extension to an answering machine (only if time to answer calls is less than 6 seconds).

WARNING: Connection of only one such series apparatus (e.g. Autodialler with telephone socket) is allowed between a main apparatus (Telephone 1) and the PSTN.

AUTODIALLER CANNOT BE PROGRAMMED FOR MAKING CALLS TO THE BT EMERGENCY (999) SERVICE.

AUTODIALLER TELEPHONE PORT

The following apparatus may be connected to this socket

- (a) simple telephones (loop disconnect or tone) dialling
- (b) feature telephones (loop disconnect or tone) dialling

PARALLEL OPERATION

The following apparatus may be connected in parallel with Autodialler

- (a) simple telephones (loop disconnect or tone) dialling
- (b) features telephones (loop disconnect or tone) dialling

If a parallel connected telephone or main apparatus is in use, Autodialler may not operate.

REN EXPLAINED

Every phone has a Ringer Equivalence Number (REN). Your exchange line only provides a small current, enough to operate the ringer of up to four phones whose REN's add up to no more than 4. The Autodialler has a REN of 1. Any other BT telephone may be assured to have a REN of 1, unless stated otherwise.

RBS (Relevant Branch System)

Please refer to BS6789 Section 6.1 1986.

8.0 TECHNICAL SPECIFICATION

Dialler supply voltage – 4.5V (3 X AA batteries)

Dialling – Up to 6 telephone numbers of between 4 and 12 digits.
Loop disconnect dialling only.

Attempts – 10 attempts for each number over an 8 to 9 hour period
(including dialling time).

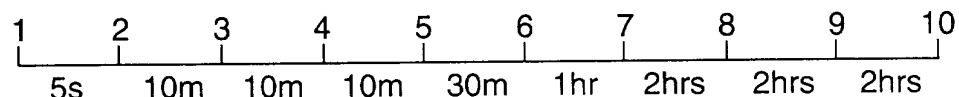

REN –	1
Detection –	dial tone, busy tone and ring tone
Telephone Port –	provided on Autodialler to accept BT type plug to BS6312. Voltage drop between main apparatus and the PSTN will not exceed 0.1v (at 40mA).
PSTN interface –	via flexible cord and plug (to BS6312) provided.
Approval –	approved to BABT requirements for connection to the PSTN (direct exchange line).
Speech Synthesis –	factory set voice message communicated through PSTN gives details of emergency location.
Alarm supply voltage –	3.0V (2 X AA batteries)
Alarm Inputs – (Terminals 1 and 2)	1 channel normally closed inputs Minimum loop current 100 micro Amps.
Magnetic contacts –	2 door/window magnetic contacts. 25 metres cable and 12 cable clips supplied.
Temperature range –	0°C to 40°C.
Dimensions of unit – (mm)	240 X 160 X 47 mm
Net Weight –	670 grams

12 month Guarantee

We shall repair or at our option replace this product if it becomes defective within 12 months of the date of purchase, provided that you return it to us with proof of purchase. A product becomes defective where it fails due to a fault in the material or workmanship, but not where the failure is caused by an accident, misuse or neglect. This guarantee does not affect your rights under statute or common law.

SMITHS AUTODIALLER

9.0 SUMMARY "QUICK-STEP" INSTRUCTIONS

(For full details refer to manual.)

Commissioning

1. Fit batteries and connect to BT line.
2. Enter PIN – (Two digit security code) → STO, PIN P1, P2, STO
3. Enter Home Telephone Number → STO, HTN, n1, n2, etc., STO
4. Enter Emergency Numbers → STO, m1, n1, n2, n3, etc., STO
STO, m2, n1, n2, n3, etc., STO
etc. | | | | |
5. Enter Sequence (if required) → STO, SEQ, m1, m2, etc. STO
6. Recall (to check stored information) → RCL, PIN
RCL, HTN
RCL, m2
| |
etc. |
RCL, SEQ
7. Connect magnetic door/window contacts to terminals marked 1 and 2.

OPERATING INSTRUCTIONS

1. Arm Autodialler: ARM, P1, P2
You hear Bleep, Bleep, Bleep, Bleep - you have 40 seconds to leave the building.
You hear "Check System" – a door or window is open - shut and ARM again.
2. After Arming: You have 40 seconds exit time.
If you open an alarmed door/window during this time you are OK as long as it is shut again before 40 seconds is over – you will hear intermittent beeps for 4 seconds.

If you hear "Check System" and Bleeeeeep (4 seconds) a door is still open after 40 seconds —
shut and ARM again.

You hear Bleep, Bleep, Bleep, Bleep after 40 seconds. Autodialler now Armed.
3. Disarm Autodialler: DIS, P1, P2
You have 40 seconds entry delay in which to disarm Autodialler

HELP LINE

If you are experiencing problems in operating your Security Autodialler, please ring our Technical Service Department on 081-450 8944.

BUSINESS REPLY SERVICE
Licence No. HA440

2



**Smiths Industries
Environmental Controls Co. Ltd.
Apsley Way (off Waterloo Road)
London NW2 7UR.**



Designed and Manufactured in the UK by
Smiths Industries Environmental Controls Co. Ltd.
Apsley Way, (off Waterloo Road), London NW2 7UR

SECURITY AUTODIALLER GUARANTEE

1. Your Autodialler is guaranteed against defects due to faulty materials or workmanship for a period of ONE YEAR from installation.
2. An Autodialler developing a defect within that period will be repaired or replaced with an equivalent unit without charge. A replacement unit will carry the unexpired portion of this guarantee.
3. Damage caused to the Autodialler through accident, misuse or neglect is excluded from this guarantee.
4. Our decision on all matters relating to functional and defective parts shall be conclusive. All defective parts replaced shall become our property.
5. This guarantee is valid within the UNITED KINGDOM only.

THIS GUARANTEE DOES NOT EXCLUDE OR RESTRICT YOUR COMMON LAW OR STATUTORY RIGHTS.

Autodialler Serial No.:Date of purchase:
(on reverse of unit.)

Please complete and return this guarantee card.

Date of Purchase:

Name & address where purchased:

.....

.....

Name & address of purchaser:

.....

.....

Name & address of user (if different):

.....

.....

Relationship between purchaser & user:
(eg. son, grandchild, friend etc.)

Autodialler Serial No:
(on reverse of unit.)