

EGS

Electrical Group

**SOLA/
HEVI-DUTY**

POWER AVAILABILITY

S4K5U6000-5

USER MANUAL



On-Line UPS
230VAC

Para español, consulte www.solaheviduty.com/products/ups/UPSmanuals.htm.

Die deutsche Fassung finden Sie auf www.solaheviduty.com/products/ups/UPSmanuals.htm.

TABLE OF CONTENTS

IMPORTANT SAFETY INSTRUCTIONS	1
WICHTIGE SICHERHEITSANWEISUNGEN	2
GLOSSARY OF SYMBOLS	3
1.0 INTRODUCTION	4
2.0 SYSTEM DESCRIPTION	5
2.1 Transient Voltage Surge Suppression (TVSS) and EMI/RFI Filters.....	5
2.2 Rectifier/Power Factor Correction (PFC) Circuit	5
2.3 Inverter	5
2.4 Battery Charger	5
2.5 DC-to-DC Converter.....	6
2.6 Battery	6
2.7 Dynamic Bypass	6
3.0 MAJOR COMPONENTS	7
3.1 Main Frame and Electronics	7
3.2 Internal Battery Packs.....	8
3.3 Removable Power Distribution Box.....	9
4.0 WHAT'S INCLUDED	10
5.0 INSTALLATION AND CONFIGURATION	11
5.1 Install the Main Cabinet	11
5.1.1 Tower UPS Installation	11
5.1.2 Rack-Mount UPS Installation	11
5.1.3 Installing the Adjustable Rack-Mount Kit—Sold Separately	12
5.2 External Battery Cabinet Installation	14
5.3 Connect the Internal Batteries Using the External Connector.....	15
5.3.1 Storage	15
5.4 Connect Input/Output Power.....	15
5.4.1 Distribution Box Electrical Connections.....	15
6.0 INITIAL START-UP AND ELECTRICAL CHECKS	17
7.0 CONFIGURATION PROGRAM	18
7.1 S4K5U6000-5 Configuration Program Features	18
7.1.1 What You Will Need.....	18
8.0 CONTROLS AND INDICATORS	19
8.1 ON/Alarm Silence/Manual Battery Test Button	19
8.2 Standby/Manual Bypass Button	19
8.3 Load Level Indicators (4 Green, 1 Amber)	20
8.4 Battery Level Indicators (5 Green)	20

8.5	Fault Indicator LED (Red)	20
8.6	Bypass Indicator LED (Amber)	20
8.7	UPS ON Indicator LED (Green)	20
8.8	Battery Indicator LED (Amber).	20
8.9	AC Input Indicator LED (Green).	20
9.0	OPERATING INSTRUCTIONS	21
9.1	Normal Mode Operation.	21
9.2	Battery Mode Operation	21
9.3	Bypass Mode Operation	21
9.4	Battery Recharge Mode	21
10.0	COMMUNICATIONS	22
10.1	Communications Interface Port.	22
10.2	Pin 4 - Remote Shutdown on Battery	22
10.3	UPS Intelligent Communications	23
10.4	Remote Emergency Power Off.	24
11.0	MAINTENANCE	25
11.1	Internal Battery	25
	11.1.1 Internal Battery Replacement	26
11.2	AC Power Connections	28
	11.2.1 S4KPAD-CEHW-MBS - Manual Bypass Switch	28
12.0	TROUBLESHOOTING	29
	12.0.1 Auto-Learning Battery Run Times	33
13.0	SPECIFICATIONS (SECHNISCHE DATEN).	34

FIGURES

Figure 1	S4K5U, front view	7
Figure 2	S4K5U, rear view	8
Figure 3	Internal battery pack with connector	8
Figure 4	Power distribution boxes, basic, optional	9
Figure 5	Tower-use support bases, spacers for external battery cabinets	11
Figure 6	Distribution box electrical connections diagram	16

TABLES

Table 1	Electrical specifications	16
Table 2	DB-9 pin assignment	22
Table 3	Indicator meanings	29
Table 4	Troubleshooting guide	30
Table 5	Alarm conditions	31
Table 6	Battery run times	32
Table 7	UPS specifications	34
Table 8	Power distribution specifications	35
Table 9	External battery cabinet specifications	35
Table 10	Technische Daten zur USV	35
Table 11	Technische Daten zur Stromverteilung	36
Table 12	Technische Daten zum externen Batteriegehäuse	37

IMPORTANT SAFETY INSTRUCTIONS

SAVE THESE INSTRUCTIONS

This Manual Contains Important Safety Instructions. Read all safety and operating instructions before operating the Uninterruptible Power Supply (UPS). Adhere to all warnings on the unit and in this manual. Follow all operating and user instructions. This equipment can be operated by individuals without previous training.

This product is designed for Commercial/Industrial use only. It is not intended for use with life support and other designated “critical” devices. Maximum load must not exceed that shown on the UPS rating label. The UPS is designed for data processing equipment. If uncertain, consult your dealer. See Limited Warranty.

This UPS is designed for use on a properly earthed (grounded), 220-240 VAC (L-N), 50Hz or 60Hz supply, for installation by qualified personnel. A qualified electrician must review and approve customer supplied wiring, circuit breakers, intended loads, and verify correct input, output and earth connections to ensure compliance with technical standards and local electrical codes of practice. Installation instructions and warning notices only for use by qualified personnel are located after the UPS operator instructions in this manual.



WARNING

This UPS should not be supplied from electrical power systems of the “IT” (Impédance à Terre) type. (IEC 364-ELECTRICAL INSTALLATION OF BUILDINGS)

ELECTROMAGNETIC COMPATIBILITY—This UPS complies with the requirements of the EMC Directive 89/336/EEC and the published technical standards. Continued compliance requires installation in accordance with these instructions and the use of manufacturer approved accessories only.



WARNING

This is a product for restricted sales distribution to informed partners. Installation restrictions or additional measures may be needed to prevent radio interference.

Operate the UPS in an indoor environment only in an ambient temperature range of 0-40°C (32-104°F). Install it in a clean environment, free from moisture, flammable liquids, gases and corrosive substances.

This UPS contains no user serviceable parts. The UPS ON/OFF push buttons do not electrically isolate internal parts. Under no circumstances attempt to gain access internally, due to the risk of electric shock or burn.

Do not continue to use the UPS if the front panel indications are not in accordance with these operating instructions, or the UPS performance alters in use. Refer all faults to your dealer.

Only trained engineers authorized by Sola/Hevi-Duty should perform troubleshooting. To replace batteries, refer all servicing to qualified service personnel. Proper disposal of batteries is required. Refer to your local laws and regulations for disposal requirements.

Never block or insert any object into the ventilation holes or other openings.

DO NOT CONNECT equipment that could overload the UPS or demand DC current from the UPS, for example: electric drills, vacuum cleaners, laser printers, hairdryers or any appliance using half wave rectification.

Storing magnetic media on top of the UPS may result in data loss or corruption.

Turn the off UPS and isolate the UPS before cleaning. Use only a soft cloth, never liquid or aerosol cleaners.

DIESE ANWEISUNGEN AUFBEWAHREN

Dieses Handbuch enthält wichtige Sicherheitsanweisungen. Lesen Sie alle Sicherheits- und Betriebsanweisungen, bevor Sie die unterbrechungsfreie Stromversorgung (USV) in Betrieb nehmen. Beachten Sie alle Warnungen am Gerät und in diesem Handbuch. Befolgen Sie alle Betriebs- und Benutzeranweisungen. Dieses Gerät kann von ungeschulten Personen betrieben werden.

Dieses Produkt ist nur für den gewerblichen / industriellen Gebrauch bestimmt. Es ist nicht für den Einsatz mit lebenserhaltenden und sonstigen als „kritisch“ bezeichneten Geräten gedacht. Die Höchstlast darf den auf dem Leistungsschild der USV aufgeführten Wert nicht überschreiten. Die USV wurde für Datenverarbeitungsgeräte entwickelt. Wenn Sie sich nicht sicher sind, wenden Sie sich an Ihren Händler. Siehe beschränkte Garantie.

Diese USV wurde zur Verwendung mit einer ordnungsgemäß geerdeten Stromversorgung mit 220 - 240 V AC und 50 Hz oder 60 Hz ausgelegt und muss von qualifiziertem Personal installiert werden. Ein qualifizierter Elektriker muss die vom Kunden bereitgestellte Verdrahtung, Schutzschalter und geplante Belastung überprüfen und genehmigen und sicherstellen, dass Eingänge, Ausgänge und Erdungsanschlüsse ordnungsgemäß installiert sind, um die Einhaltung der technischen Normen und örtlichen Elektrovorschriften zu gewährleisten. Die Anweisungen zur Installation und Warnhinweise, die nur für qualifiziertes Personal gelten, befinden sich hinter den Bedieneranweisungen in diesem Handbuch.



ACHTUNG

Diese USV sollte nicht durch Stromversorgungssysteme des Typs „IT“ (Impédance à Terre) gespeist werden. (IEC 364 - ELEKTROINSTALLATION IN GEBÄUDEN)

ELEKTROMAGNETISCHE VERTRÄGLICHKEIT - Diese USV entspricht den Erfordernissen der EMC-Richtlinie 89/336/EEC und den veröffentlichten technischen Normen. Eine kontinuierliche Einhaltung erfordert die Installation gemäß dieser Anweisungen sowie die Verwendung von ausdrücklich vom Hersteller genehmigtem Zubehör.



ACHTUNG

Dieses Produkt ist für den eingeschränkten Vertrieb an informierte Partner gedacht. Zur Verhinderung von Funkstörungen sind eventuell Installationseinschränkungen oder zusätzliche Maßnahmen erforderlich.

Die USV darf nur innen in einem Umgebungstemperaturbereich von 0-40 °C (32 °F bis +104 °F) betrieben werden. Es muss in einer sauberen Umgebung installiert werden, die frei von Feuchtigkeit, brennbaren Flüssigkeiten, Gasen oder korrodierenden Substanzen ist.

Diese USV enthält keine vom Benutzer zu wartenden Teile. Die EIN/AUS-Drucktasten der USV haben keine elektrische Isolierungsfunktion bei den internen Komponenten. Auf keinen Fall darf versucht werden, auf das Innere des Gerätes zuzugreifen, da Sie sich ansonsten dem Risiko eines Stromschlags oder von Verbrennungen aussetzen.

Wenn die Anzeige an der Vorderplatte nicht mit diesen Betriebsanweisungen übereinstimmt oder die Leistung der USV schwankt, darf sie nicht weiter verwendet werden. Melden Sie alle Fehler Ihrem Händler.















Nur geschulte Techniker, die von Sola/Hevi-Duty entsprechend autorisiert wurden, dürfen eine Fehlersuche durchführen. Beim Ersetzen von Batterien müssen alle Wartungsmaßnahmen von qualifiziertem Service-Personal durchgeführt werden. Batterien müssen ordnungsgemäß entsorgt werden. Die Anforderungen für die Entsorgung entnehmen Sie bitte den örtlichen Gesetzen und Vorschriften.

Die Belüftungslöcher und sonstige Öffnungen dürfen auf keinen Fall blockiert werden, und es dürfen keine Gegenstände in sie gesteckt werden.

ES DÜRFEN KEINE GERÄTE ANGESCHLOSSEN WERDEN, die zu einer Überlastung der USV führen oder mit Gleichstrom versorgt werden müssen, zum Beispiel: Elektrobohrer, Staubsauger, Laserdrucker, Föhne oder sonstige Haushaltsgeräte, die Halbwellengleichrichtung verwenden.

Das Lagern von Magnetdatenträgern oben auf der USV kann zu einem Datenverlust oder der Zerstörung von Daten führen. Vor der Reinigung muss die USV ausgeschaltet und isoliert werden. Es darf nur ein weiches Tuch, niemals Flüssigkeit oder Aerosol-Reiniger verwendet werden.

GLOSSARY OF SYMBOLS

	Risk of electrical shock Gefahr eines Stromschlags
	Indicates caution followed by important instructions Zeigt einen Vorsichtshinweis an, auf den wichtige Anweisungen folgen
	AC input Wechselstromeingang
	AC output Wechselstromausgang
	Requests the user to consult the manual Fordert den Benutzer dazu auf, das Handbuch zu konsultieren
	Indicates the unit contains a valve-regulated lead acid battery Gibt an, dass das Gerät über eine Bleisäurebatterie mit Ventilregelung verfügt
	Recycle Recycling zuführen
	DC voltage Gleichspannung
	Equipment grounding conductor Geräteerdleiter
	Bonded to ground Erdung mit Potentialausgleich
	AC voltage Wechselspannung
	ON/Alarm Silence/Battery Test EIN/Alarm stumm schalten/Batterietest
	OFF/Bypass AUS/Bypass
	Indicates the position of a fuse Zeigt die Position einer Sicherung an

1.0 INTRODUCTION

Congratulations on your choice of the Sola/Hevi-DutyS4K5U6000-5 Uninterruptible Power System (UPS). It provides conditioned power to microcomputers and other sensitive electronic equipment.

Upon generation, AC power is clean and stable. However, during transmission and distribution it may be subject to voltage sags, spikes, or complete power failure that may interrupt computer operations, cause data loss, or even damage equipment. The S4K5U protects equipment from these disturbances.

The S4K5U comes in nominal power ratings of 4500 VA and 6000 VA. Complete model specifications appear at the end of this manual.

The S4K5U is a compact, on-line UPS. An on-line UPS continuously conditions and regulates its output voltage, whether mains power is present or not. It supplies connected equipment with clean sine-wave power. Sensitive electronic equipment operates best from sinewave power.

For ease of use, the S4K5U features a light-emitting diode (LED) display to indicate both load percentage and battery capacity. It also provides self-diagnostic tests, a combination ON/Alarm Silence/Manual Battery Test button, a Standby button, user configurable program, and two levels of alarms when the unit is operating on battery.

The S4K5U has an interface port for communication between the UPS and a network server or other computer systems. This port provides detailed operating information including voltages, currents, and alarm status to the host system when used in conjunction with Sola/Hevi-Duty MultiLink™ software. MultiLink software can also remotely control UPS operation.

2.0 SYSTEM DESCRIPTION

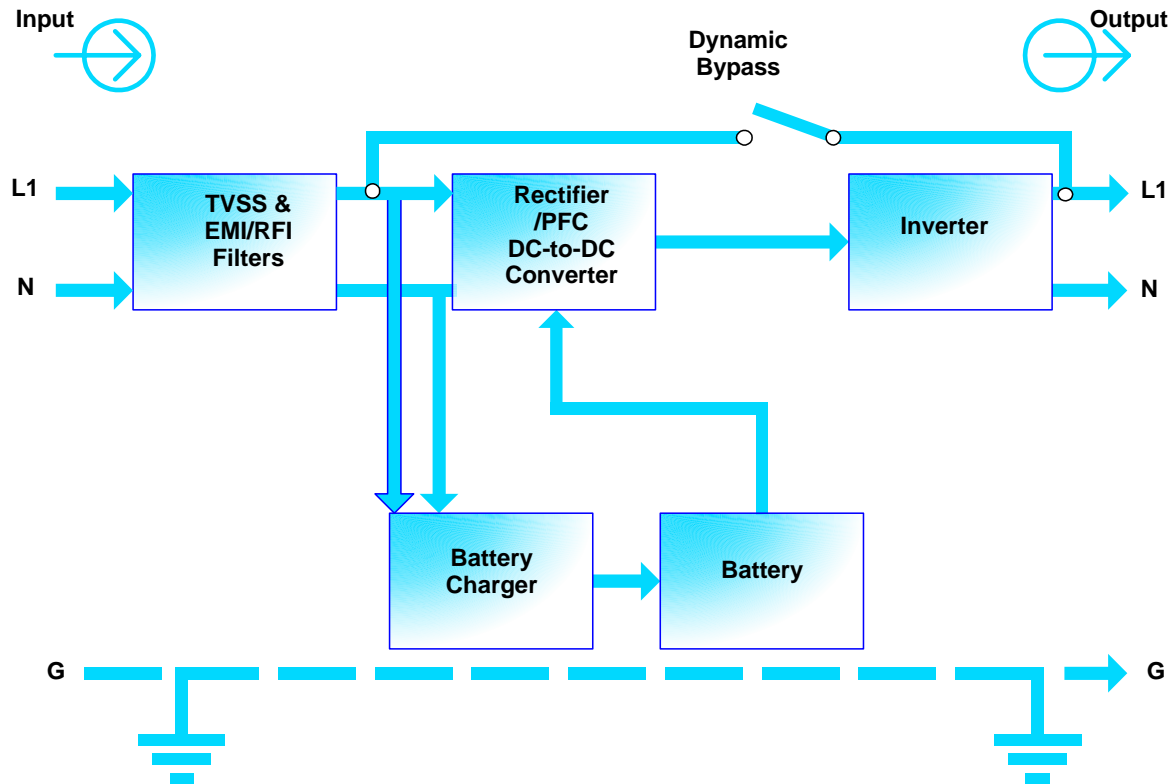

2.1 Transient Voltage Surge Suppression (TVSS) and EMI/RFI Filters

These UPS components provide surge protection and filter both electromagnetic interference (EMI) and radio frequency interference (RFI). They minimize any surges or interference present in the mains line and keep the sensitive equipment protected.

2.2 Rectifier/Power Factor Correction (PFC) Circuit

In normal operation, the rectifier/power factor correction (PFC) circuit converts mains AC power to regulated DC power for use by the inverter while ensuring that the waveshape of the input current used by the UPS is near ideal. Extracting this sinewave input current achieves two objectives:

- The mains power is used as efficiently as possible by the UPS.
- The amount of distortion reflected on the mains is reduced.

This results in cleaner power being available to other devices in the building not being protected by the S4K5U.

2.3 Inverter

In normal operation, the inverter utilizes the DC output of the power factor correction circuit and inverts it into precise, regulated sinewave AC power. Upon a mains power failure, the inverter receives its required energy from the battery through the DC to DC converter. In both modes of operation, the UPS inverter is on-line and continuously generating clean, precise, Regulated Ac Output Power.

2.4 Battery Charger

The battery charger utilizes energy from the mains power and precisely regulates it to continuously float charge the batteries. The batteries are being charged whenever the S4K5U is connected to mains power.

2.5 DC-to-DC Converter

The DC to DC converter utilizes energy from the battery system and raises the DC voltage to the optimum operating voltage for the inverter. This allows the inverter to operate continuously at its optimum efficiency and voltage, thus increasing reliability.

2.6 Battery

The S4K5U utilizes valve-regulated, nonspillable, lead acid batteries. To maintain battery design life, operate the UPS in an ambient temperature of 20°C to 25°C (68°F to 77°F). Optional external battery cabinets are available to extend battery run times.

2.7 Dynamic Bypass

The S4K5U provides an alternate path for mains power to the connected load in the unlikely event of a UPS malfunction. Should the UPS have an overload, overtemperature, or UPS failure condition, the UPS automatically transfers the connected load to bypass. Bypass operation is indicated by an audible alarm and illuminated amber Bypass LED (other LEDs may be illuminated to indicate the diagnosed problem). To manually transfer the connected load from the inverter to bypass, press the Standby button once.



NOTE

The bypass power path does NOT protect the connected equipment from disturbances in the mains supply.

3.0 MAJOR COMPONENTS

The S4K5U is composed of three major assemblies to provide easier handling, installation, and versatility.

3.1 Main Frame and Electronics

This 5U cabinet is shipped with internal batteries installed and a bypass hardwire distribution box attached and ready to install.

Figure 1 S4K5U, front view

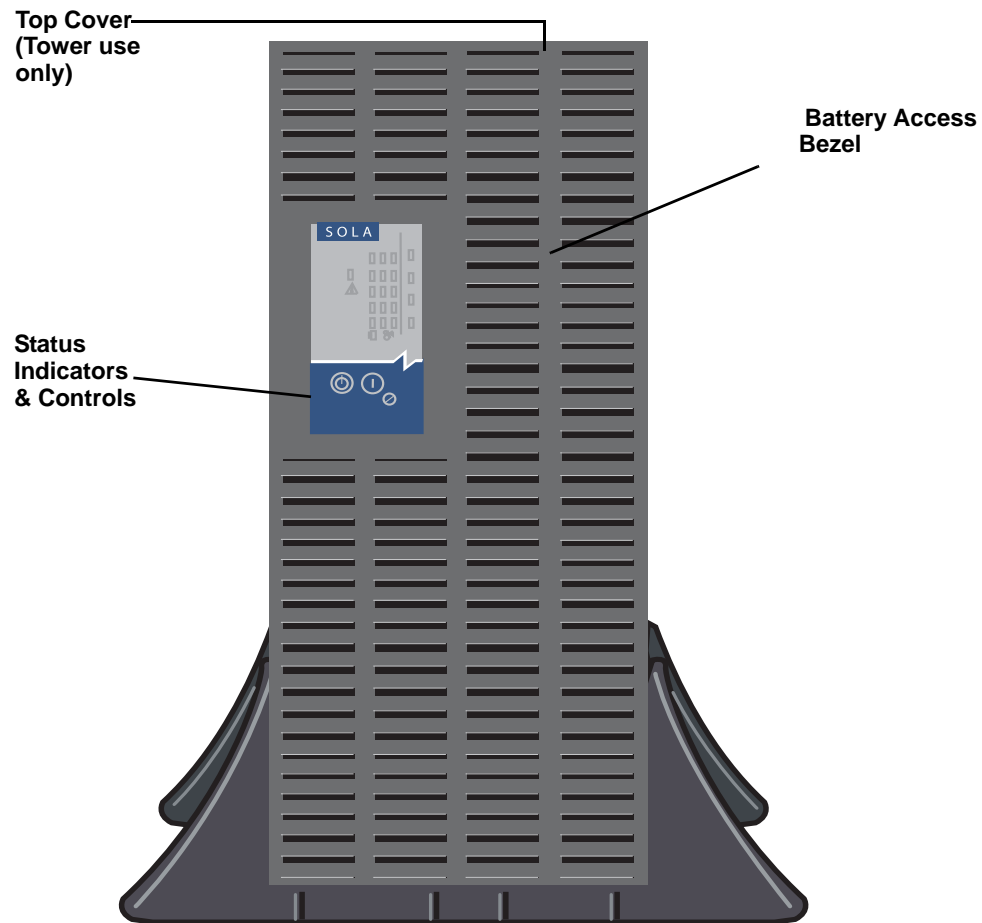
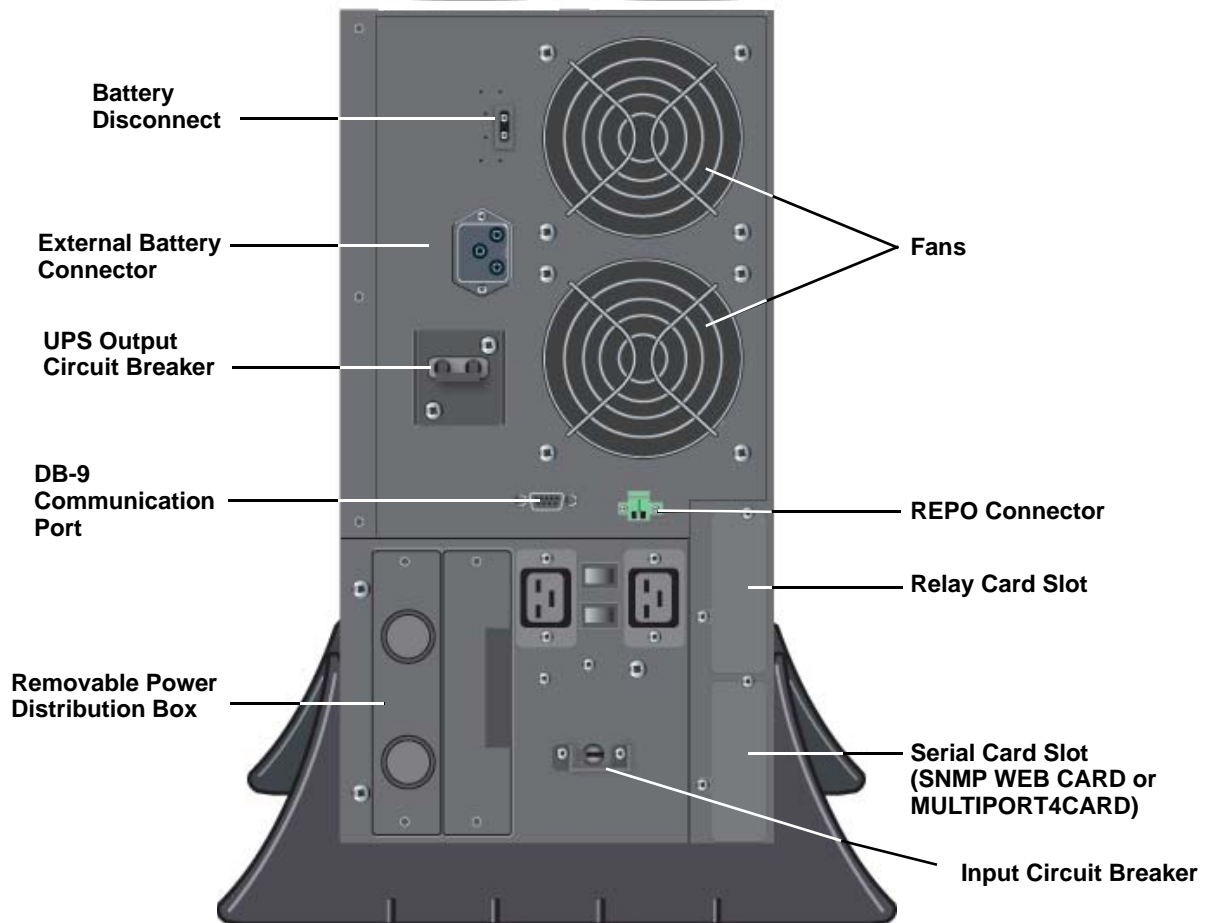

Figure 2 S4K5U, rear view



3.2 Internal Battery Packs

The UPS has two internal battery packs behind a battery access door on the front of the unit. Each pack is fitted with a connector to link to the UPS.

Figure 3 Internal battery pack with connector

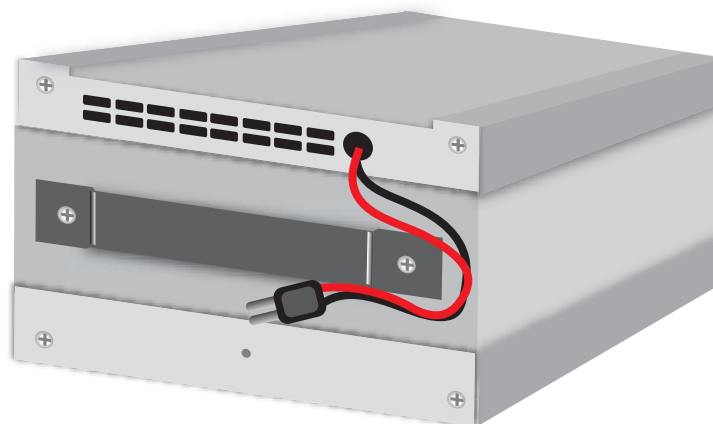

3.3 Removable Power Distribution Box

The UPS arrives with a bypass hardware power distribution pack installed. This box always contains the UPS input circuit breaker.

Optional versions may be available to replace the standard box for custom installations.

Figure 4 Power distribution boxes, basic, optional

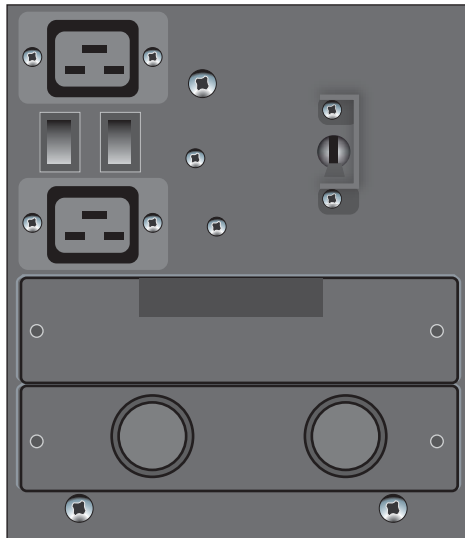

**Optional Hardwire Power Dist. Box
S4KPAD-CEHW**



**Hardwire Power Distribution Box with
Maintenance Bypass Switch
S4KPAD-CEHW-MBS**



NOTE

*Hardwire and hardwire/receptacle boxes that include a manual bypass switch allow AC power to continue to flow from the mains input to the load while the box is removed from the UPS. For details, refer to **11.2 - AC Power Connections**.*

4.0 WHAT'S INCLUDED

The S4K5U are shipped with the following items:

- S4K5U6000-5 user manual
- Vertical display overlay
- MultiLink software CD
- MultiLink serial cable, 10 ft (3m)
- Rack mount handles
- Support base - 2
- Mounting hardware
- Configuration program disk
- DB9 port cover

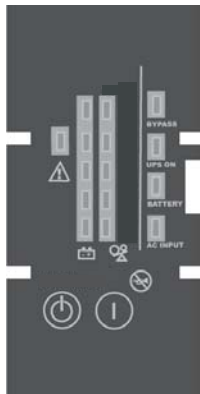

Vertical display

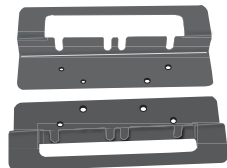

Rack mount handles



MultiLink software CD

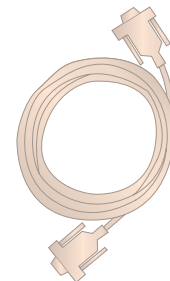

MultiLink serial cable 10 ft (3m)

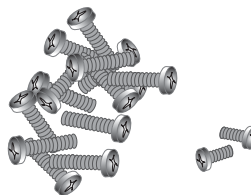

Mounting hardware



Configuration disk

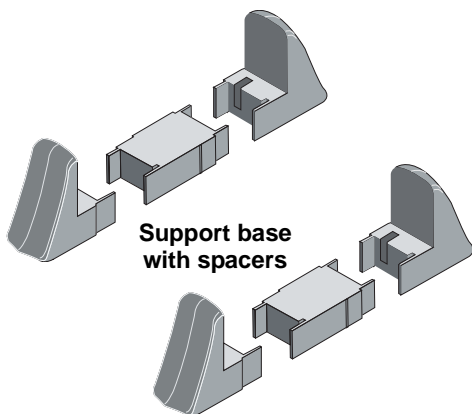

Support base with spacers

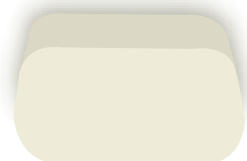

DB9 port cover

5.0 INSTALLATION AND CONFIGURATION

Do NOT attempt to start the UPS, turn on any circuit breaker or energize the input power until instructed to do so in **6.0 - Initial Start-Up and Electrical Checks**.

Visually inspect the UPS for freight damage. Report any damage to the carrier and your local dealer or Sola/Hevi-Duty representative.



CAUTION

The UPS is heavy (see **13.0 - Specifications (Sechnische Daten)**). Take proper precautions when lifting or moving it.

Install the S4K5U indoors in a controlled environment, where it cannot be accidentally turned off. Place it where air flows unrestricted around the unit. The installation location must be free of water, flammable liquids, gases, corrosives and conductive contaminants. Maintain a minimum clearance of 100mm (4 inches) in the front and rear of the UPS. Maintain an ambient temperature range of 0 to 40°C (32 -104°F).



NOTE

UPS operation in sustained temperatures above 25°C (77°F) reduces battery life.

This device is intended for use in an Installation Category II environment.

5.1 Install the Main Cabinet

The S4K5U may be installed in either a tower configuration or in a rack, depending on available space and use considerations. Determine the type of installation and follow the appropriate instructions in either **5.1.1 - Tower UPS Installation** or **5.1.2 - Rack-Mount UPS Installation**.

5.1.1 Tower UPS Installation

When using the S4K5U in a tower configuration, use the included support base (shown below, left) to stabilize the UPS. If any external battery cabinets are added, they will include spacers to accommodate the additional cabinets (shown below, right).

Figure 5 Tower-use support bases, spacers for external battery cabinets

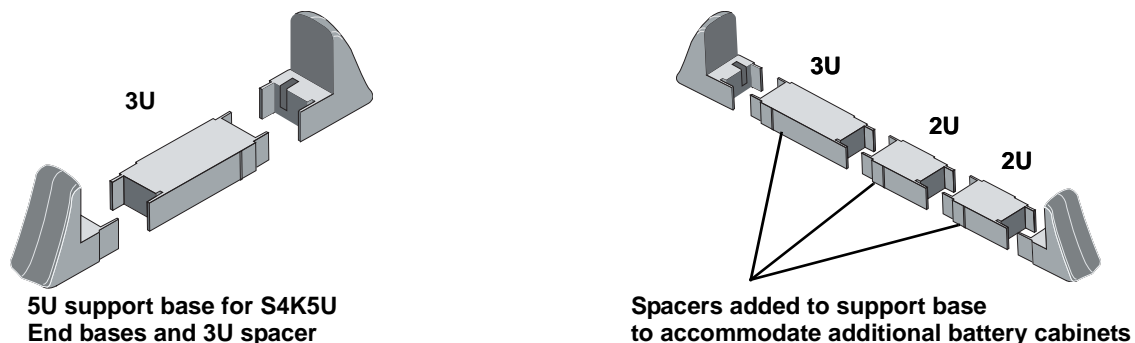

5.1.2 Rack-Mount UPS Installation

When using the S4K5U in a rack-mount configuration, the UPS must be supported by a slide kit, fixed rails or a shelf.

When using the optional Adjustable Rack Mount Kit, you will use the following instructions. The figures accompanying **5.1.3 - Installing the Adjustable Rack-Mount Kit—Sold Separately** shows the positioning of the rack-mounting brackets. Taking the internal batteries out of the UPS during rack installation is recommended. This will make the UPS cabinet lighter and easier to handle.



CAUTION

Only three (3) M4 screws are used on the side of the S4K5U where the Power Distribution Box is located. The fourth mounting hole is above the Power Distribution Box and is not used.

5.1.3 Installing the Adjustable Rack-Mount Kit—Sold Separately

This kit contains parts needed to mount several different models of UPS and external battery cabinets into EIA310-D standard four-post racks that are 18-32" deep (457-813mm). The weight limit per pair of adjustable rack-mounting brackets is 91 kg (200lbs.).

Parts included are:

Item	Quantity
Rear bracket members	2
Front bracket members	2
Inner bracket members	2
M4 x 8mm machine screws	16
M4 locking hex nuts	8
M5 x 16 mm machine screws	12
Grease packet.	1

Tools needed for installation are:

- one Phillips screwdriver
- one 7mm wrench

The adjustable rack-mounting brackets (part # SRS18-32) feature retaining latches to prevent users from inadvertently sliding the UPS or battery cabinet out of the rack.

To install the rack mount brackets:

1. Unpack two (2) rack-mounting bracket assemblies and mounting hardware from this kit. Bracket assemblies are interchangeable between left-hand or right-hand.
Remove inner member of each bracket assembly as shown at right by extending it to its outermost position, depressing the retaining latch and then pulling the inner member out of the bracket assembly.
2. Determine the height position inside the rack enclosure where you want to mount the UPS or battery cabinet.

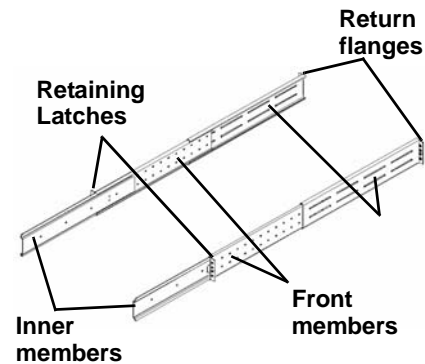

CAUTION

Reduce the risk of tipping the rack enclosure by placing the UPS or battery cabinet in the lowest possible rack position.

3. Install the rear member of each bracket assembly into the rack enclosure with two (2) M5 screws provided in this kit (see figure at right). The return flanges on the bracket assembly fit to the inside of rack mounting rails. Insert screws loosely (finger-tight) into the top and bottom holes of the return flange on the rear member. Extend the bracket assembly by sliding the front member forward until it touches the front rack mounting rail. Insert two (2) M5 screws loosely (finger-tight) into the top and bottom holes of the return flange on each front member. Make sure that the bracket assemblies are at the same mounting height on all four (4) rack mounting rails.

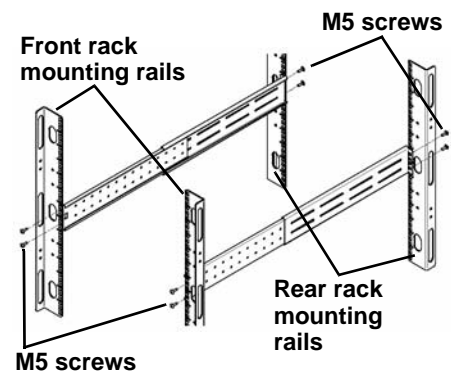

4. Get eight (8) M4 screws and eight (8) M4 nuts from the hardware pack in this kit. Each nut has a locking, nylon insert that begins gripping the screw when it is halfway tight. Make sure to tighten the nut and screw completely to ensure locking action. Fasten the rear member and the front member together using (4) screws and (4) nuts per bracket assembly as shown in at right. For maximum support, insert fasteners for each bracket assembly as far apart as possible, depending on rack depth, while still joining both members (see figures at right). Check alignment of bracket assemblies and **TIGHTEN ALL SCREWS FROM Steps 2 and 3.**
5. Prepare the UPS or battery cabinet (the “equipment”) for rack mounting by following instructions in the equipment’s user manual. The equipment may require additional parts to be added or parts to be removed for rack mounting. After it is prepared, lay the equipment in rack-mounting position. Fasten the inner members from **Step 1** to the equipment on both sides as shown at right with eight (8) M4 screws provided in the kit. Make sure retaining latch is near the rear of the equipment as shown (see figure at right).
6. Open the grease packet provided in the kit. Apply a bead of grease 25mm (1”) long at four (4) places inside the bottom, curved tracks of the front members as shown below right. The grease will allow the equipment to slide into the bracket assemblies more easily.



CAUTION

Lifting equipment into the rack may be a two-person job, depending on the weight of the equipment. Sola/Hevi-Duty recommends taking the internal batteries out of the UPS during rack installation. This will make the UPS cabinet lighter and easier to handle. The S4K5U weighs 67kg (151lb). For the battery cabinet’s weight, see the unit’s user manual.

7. Insert the equipment, with inner members attached in **Step 5**, into the bracket assemblies by inserting the top and bottom edges of the inner members into the top and bottom curved tracks of the front members and sliding the equipment into the rack (see figure at right). Ends of inner members are tapered to allow the rear of the equipment to be angled upward before insertion, if space allows. Then the rear, bottom edges of the inner members can be placed into the front edge of the bottom tracks and the front of the equipment can be tipped up so they are level to insert the top edges of the inner members before sliding the equipment into the rack (see figure below right). The equipment should move smoothly into the bracket assemblies. If it does not, recheck the alignment of the front and rear members from **Steps 2 and 3.**
8. Secure the front of the equipment to the rack mounting rails to prevent the equipment from sliding out of position. If securing holes are provided on the front of the equipment that align with the center holes on the return flange of the front members, you can use the four (4) extra M5 screws provided in the kit to secure the equipment. Otherwise, the equipment should be secured to the front of the rack with four (4) customer-supplied fasteners.

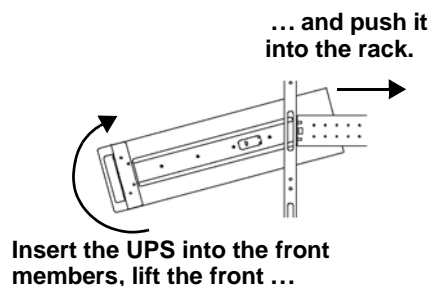
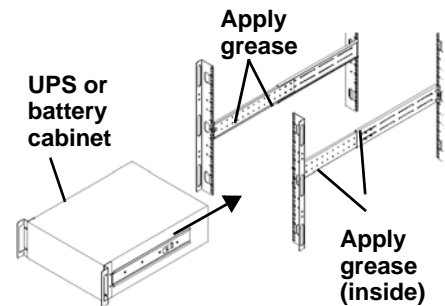
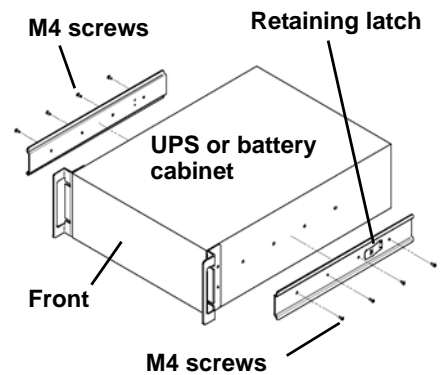
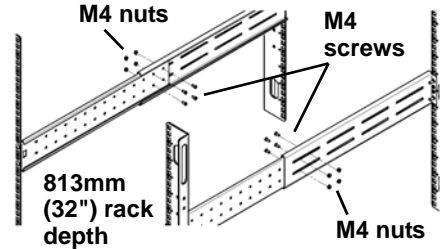
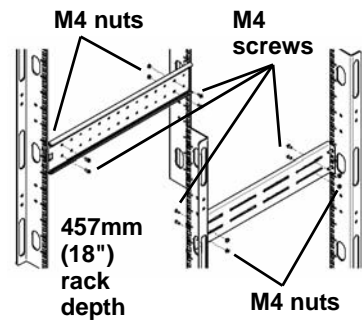

5.2 External Battery Cabinet Installation

Optional Sola/Hevi-Duty external battery cabinets may be connected to the UPS to provide additional battery run time. External battery cabinets are designed to be placed on one side of the UPS or stacked beneath the UPS.



CAUTION

The external battery cabinet(s) are heavy (see **13.0 - Specifications (Sechnische Daten)**). External battery cabinets can be used in rack-mount or tower configuration. Take proper precautions when lifting them.



VORSICHT

Externe Batteriegehäuse sind schwer (siehe **13.0 - Specifications (Sechnische Daten)**). Externe Batteriegehäuse können in einer Rack-Montage- oder Turmkonfiguration eingesetzt werden. Ergreifen Sie die entsprechenden Vorsichtsmaßnahmen, wenn sie gehoben werden müssen.

1. Visually inspect the external battery cabinet for freight damage. Report damage to the carrier and your local dealer or Sola/Hevi-Duty representative.
2. For slide rail installations, first remove the top/side fin. Top/side fin slides forward and then lift up to remove. Optional rack-mount handles are shipped with the external battery cabinet and may be installed at this time if desired.
3. Securing hardware and slide rails are sold separately. Please contact your local dealer or Sola/Hevi-Duty representative for these additional options and any assistance needed. Fasten the slides into position with the screws per the instructions included with the slide rails.
4. Use the enclosed support bases for the tower option to prevent tip-over. One additional set of support base extensions ships with each external battery cabinet.
5. Connect the supplied external battery cabinet cable to the rear of the external battery cabinet, then to the rear of the UPS.
6. The UPS is now equipped with additional backup battery run time. For approximate battery run times, refer to **Table 6**.



NOTE

*You must use the included configuration program to program the UPS for the number of external battery cabinets connected. Instructions for the configuration program are in **7.0 - Configuration Program**.*

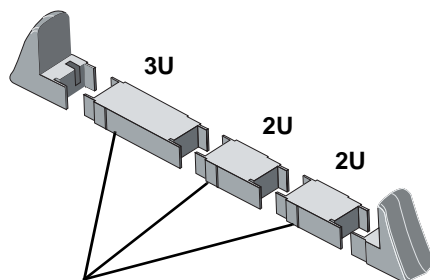

Spacers added to support base to accommodate additional battery cabinets

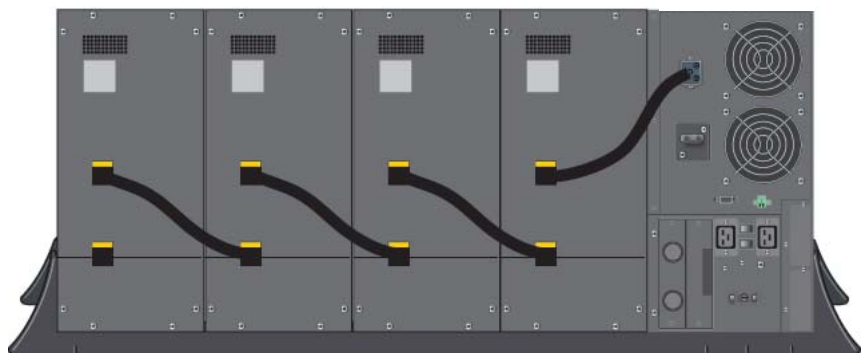

5.3 Connect the Internal Batteries Using the External Connector

The internal connectors of the internal battery packs will be connected when shipped. However, the internal batteries will be disconnected from the UPS using a rear panel connector. The connector attaches to the UPS in both the open and closed position using two screws. The picture on the left shows the connector in the open position, as shipped.

When the UPS is installed, remove the two screws to release the connector. Plug the connector into the socket. The internal batteries are now connected to the UPS electronics. Install the two screws to secure the connector in the closed position.

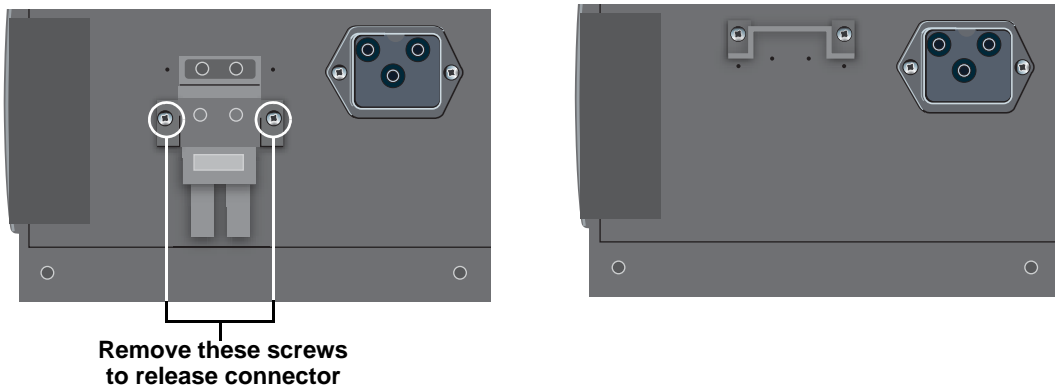

5.3.1 Storage

If the UPS is to be shipped or stored for an extended time, the connector should be removed and attached in the open position, as shown above. This will minimize any standby current drain on the batteries.

5.4 Connect Input/Output Power

The UPS should arrive with the bypass hardwire box attached. If the box needs to be exchanged for an optional model, remove and install the desired box using the three captive screws marked in the illustration at right.

To remove:

Loosen the screws about 20 turns until the box can be pulled away from the UPS.

To install:

Align the connectors on the box and UPS. Push the box into place. While holding the box firmly against the UPS, tighten the three captive screws until the box is secure. Do not over tighten.

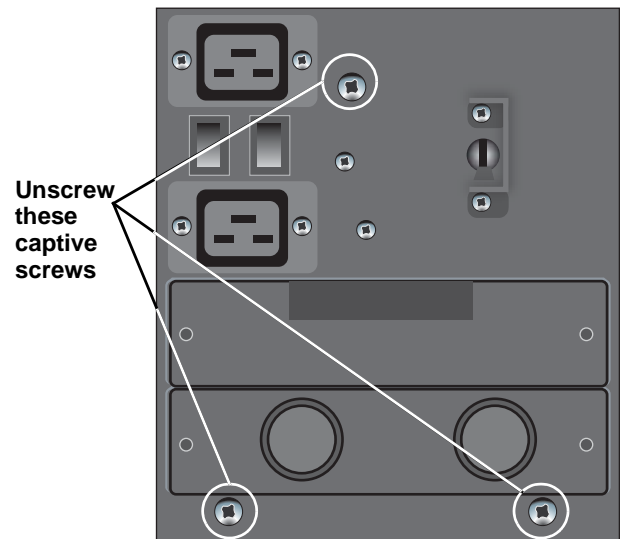

5.4.1 Distribution Box Electrical Connections

Electrical connections are made through a removable power distribution box that attaches to the rear of the UPS.

The installer must provide a 32A branch circuit breaker. The Input circuit breaker on the distribution box and the Output circuit breaker on the rear fixed-panel of the UPS disconnect all power between the main cabinet and the distribution box.

Models equipped with a manual bypass switch pass bypass power directly to the bypass switch from the input terminal block. The input circuit breaker on the distribution box does not disconnect power from the manual bypass switch.

Figure 6 Distribution box electrical connections diagram

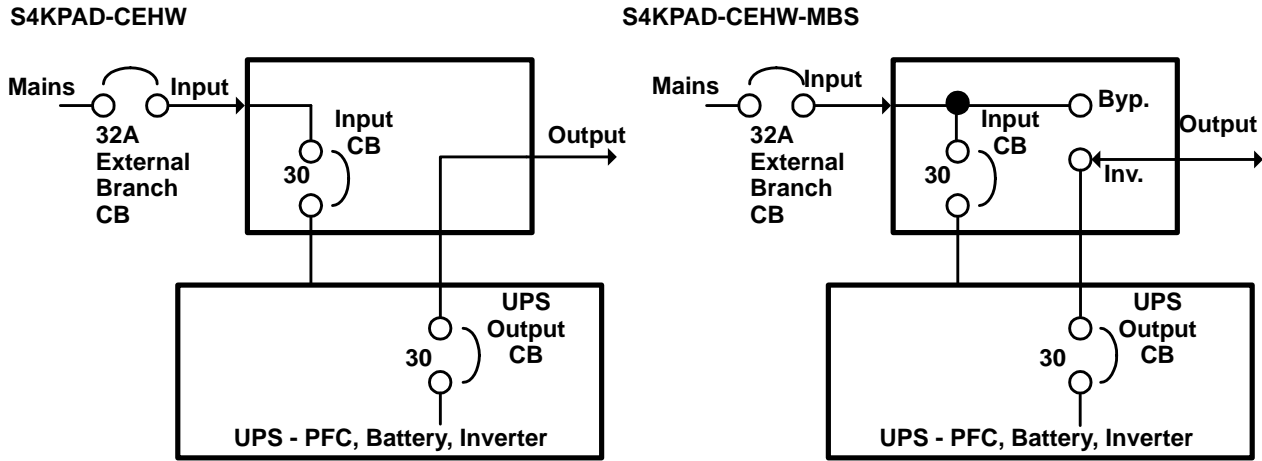

S4KPAD-CEHW and S4KPAD-CEHW-MBS Terminal Block Connections

Conduit entry holes are provided on the rear and side of the box. Input and output wiring should not share the same conduit.

Table 1 Electrical specifications

Input Current Rating	Recommended (Maximum) External Overcurrent Protection	Recommended Wire (Including ground wire) (758C copper wire)	Maximum Wire Accepted by Terminal Block	Terminal Tightening Torque
24A	32A	6-10mm ² (8-10AWG)	10mm ² (8AWG)	2.26 Nm (20 in-lb)

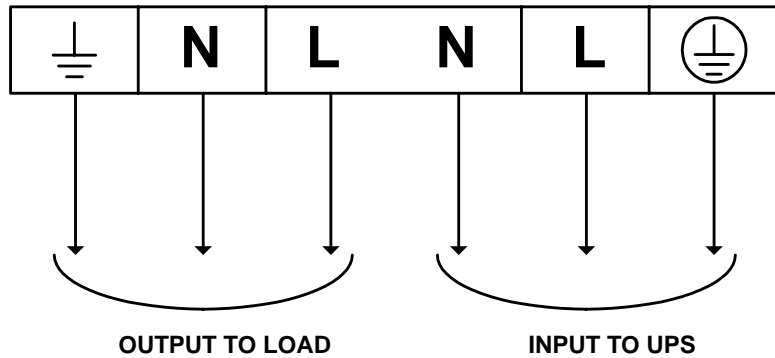
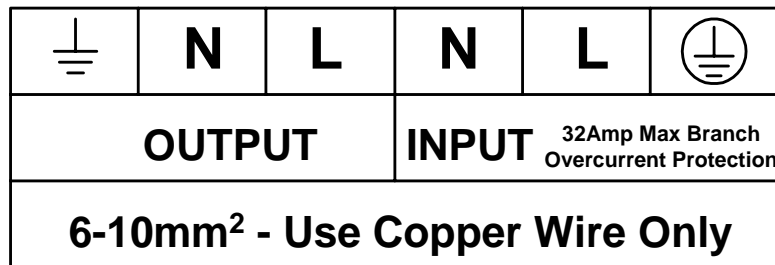

NOTE

- Note 1 The installer must provide circuit breaker protection according to local codes. The mains disconnect should be within sight of the UPS or have an appropriate lock-out. Maintain service space around the UPS or use flexible conduit.*
- Note 2 The installer must provide output distribution panels, circuit breaker protection, or emergency disconnects according to local codes. Output circuits must not share a common conduit with any other wiring.*

6.0 INITIAL START-UP AND ELECTRICAL CHECKS

1. Verify that the Input Output circuit breakers are off.
2. During initial system checks, disconnect all loads (open load disconnects).
3. Inspect all wiring, cables, and connection.
4. If external battery cabinets are used, verify that the battery interconnect cables are fully inserted in the sockets.
5. If you are using a distribution box that includes a Manual Bypass Switch, place the switch in BYPASS position.
6. Turn on the branch circuit disconnect to apply voltage to the input terminal block.
7. Using a voltmeter, verify the expected L1-N voltage.
If no Manual Bypass Switch is used, there will be no output voltage at this time. If a Manual Bypass Switch is used, verify that the same voltages appear at the Output terminals. If a Manual Bypass Switch is used, the Bypass lamp will light by the switch. If no manual bypass switch is used, there will be no output voltage at this time.
8. After verifying proper input voltage to the UPS terminal block, turn off the branch circuit power, close all access panels to the distribution box, and reapply input power.
9. Close the Input circuit breaker located on the distribution box. The green AC INPUT lamp should illuminate on the front panel.
10. Press the ON button for 1 second. The BYPASS lamp will light for several seconds before the UPS ON lamp turn on continuously. If the batteries are determined to charged above 80%, an automatic battery test will run for about 15 seconds.
11. Close the Output circuit breaker on the rear of the UPS. If a Manual Bypass Switch is used, the Inverter lamp by the switch will light. If a Manual Bypass Switch is used, transfer the switch to the Inverter position. The output terminal block will be powered at this time.
12. Perform a Manual Battery Test - Press the ON button for 1 second. The front BATTERY lamp will light for about 15 seconds and then return to only the UPS ON and AC INPUT lamps being on.
13. Review all setting option provided by the configuration program. Some changes require that the UPS be OFF. If this is the case, these should be programmed before powering the loads. The configuration program is described in the next section.
14. Connect all loads for normal operation.

7.0 CONFIGURATION PROGRAM

The final step of installation may require custom configuration of your UPS using the enclosed configuration program. Some configuration settings may be changed only while the UPS is off. These should be set before the UPS is put into full-time service powering the critical load.

For most users operating with 230VAC and with no external batteries, the factory default settings will be adequate.

7.1 S4K5U6000-5 and S4K5U4500-5 Configuration Program Features

- Select one of three L-N output voltages to match local voltages.
- Enable/Disable Auto-Restart.
- Select frequency converter operation with a fixed output frequency of 50 or 60 Hz.
- Set the Low Battery Warning alarm time from 2 to 30 minutes.
- Enable/Disable the Auto-Battery test.
- Set the Auto-Battery test to 7, 14, 21, or 28 days.
- Specify the number of external battery cabinets connected to the UPS to adjust the remaining run time calculations reported by Sola/Hevi-Duty software products.
- Modify the shutdown setting of DB-9 pin 6 (for information on pin assignments, see **Table 2**).

7.1.1 What You Will Need

In addition to the S4K5U UPS, you will need the configuration program diskette and serial cable (beige or tan, 3-wire: GND, TX, RX; straight through 2-2, 3-3, 5-5) included in the UPS accessory box. A Windows 95® or later computer, desktop or laptop, is also required to set up and run the configuration program.

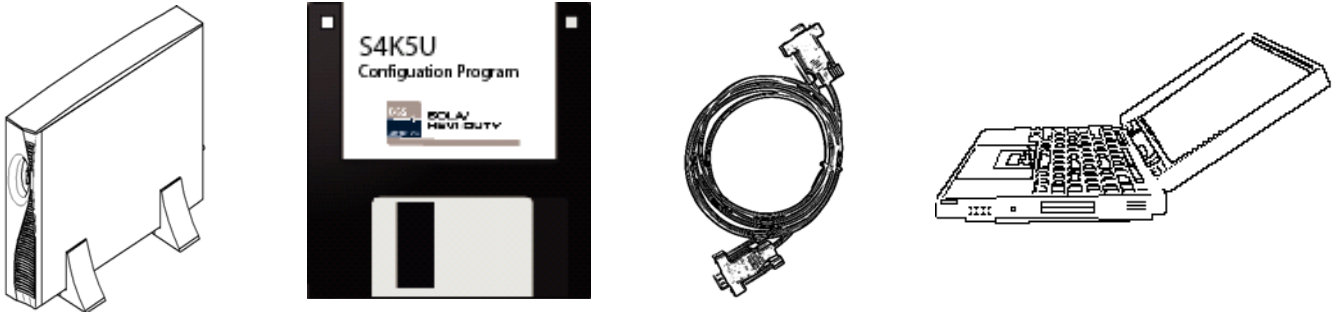

8.0 CONTROLS AND INDICATORS

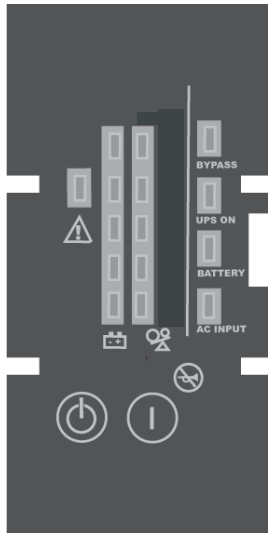

All indicators illuminated for illustration only.

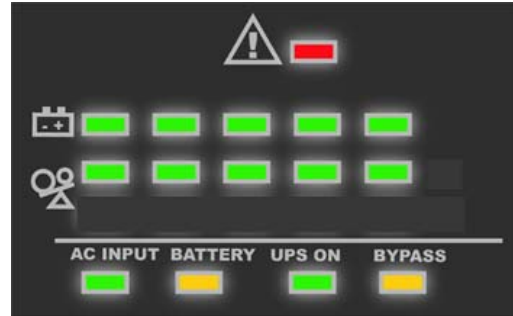

8.1 ON/Alarm Silence/Manual Battery Test Button

This button controls output power to connected load(s) and has three functions:

- ON
- Alarm Silence
- Manual Battery Test

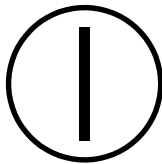

ON - Pressing this button will start up the UPS in order to provide conditioned and protected power.

Alarm Silence - To silence alarms, press this button for at least one Second. After the alarm is silenced, the S4K5U will reactivate the alarm system to alert of additional problems.



NOTE

The **LOW BATTERY** and **BYPASS** reminder alarms **CANNOT** be silenced.

Manual Battery Test - To initiate a manual battery test, press the ON button for at least one second while operating from mains power with no alarm conditions present.

- If only three of the five Battery LEDs illuminate, allow the UPS to recharge the batteries for 24 hours.
- After 24 hours, retest the batteries.
- After the batteries have been retested, if only three of the five Battery LEDs illuminate, contact your local dealer, Sola/Hevi-Duty representative or Sola/Hevi-Duty Technical Support Services.

8.2 Standby/Manual Bypass Button

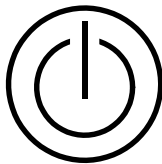

This button controls output power to connected load(s) and has dual functions: Standby and Manual Bypass.



CAUTION

Pressing the OFF/Bypass button once will cause the load to be transferred to bypass power. Pressing the OFF/Bypass button three times within 4 seconds will change the unit from UPS ON to UPS off mode. This will result in a loss of power to the receptacles and connected loads, but the UPS's circuits remain live, charging the units battery. Perform all necessary shutdown procedures on connected loads before pressing this button three times or two times from bypass mode.

8.3 Load Level Indicators (4 Green, 1 Amber)

The load level indicators display the approximate electrical load placed upon the UPS at all times.

8.4 Battery Level Indicators (5 Green)

The battery level indicators display approximate battery capacity at all times.

The S4K5U is equipped with automatic and remote battery test features. The automatic test occurs every 14 days (this option is user configurable) if mains has not been interrupted. Should the battery fail this test, the red Fault indicator LED along with the A and C diagnostic LEDs will illuminate and an alarm will sound (refer to **12.0 - Troubleshooting**). The remote test feature functions with Multi-Link 3.x software and can remotely initiate the battery test.

8.5 Fault Indicator LED (Red)

The Fault indicator LED is illuminated if the UPS has detected a problem. Also, one or more of the battery level indicators may be illuminated (refer to **12.0 - Troubleshooting**).

8.6 Bypass Indicator LED (Amber)

The Bypass indicator LED is illuminated when the UPS is operating from bypass power. An alarm will sound indicating the UPS detected a problem, or the manual bypass function has been activated.

8.7 UPS ON Indicator LED (Green)

The UPS ON indicator LED is illuminated when the UPS inverter is operating and supplying power to the connected loads.

8.8 Battery Indicator LED (Amber)

The Battery indicator LED is illuminated when the UPS is operating on battery.

8.9 AC Input Indicator LED (Green)

The AC Input indicator LED is illuminated when mains power is available and within the input specifications.

9.0 OPERATING INSTRUCTIONS

9.1 Normal Mode Operation

During normal operation, mains power provides energy to the UPS. The filters, power factor correction circuit and the inverter process this power to provide computer grade power to connected loads. The UPS maintains the batteries in a fully charged state. The four green load level LEDs indicate an approximate level of load in 25% increments. If the UPS becomes loaded beyond full rating, the fifth (amber) LED indicator will illuminate and the UPS will sound an audible alarm. The display template indicates the percentage of load (10% of load shown in example) on the UPS output.

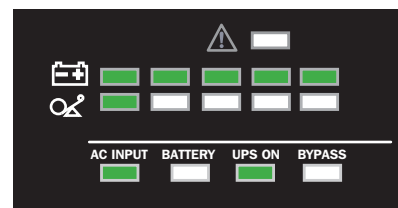

Normal Mode Operation
Batteries at 100% Charge
Load at 10%

9.2 Battery Mode Operation

Battery mode occurs in event of an extreme input voltage condition or complete mains failure. The battery system supplies power through the DC to DC converter to the inverter to generate power for the connected load. During battery mode an alarm sounds every 10 seconds. This will change to two beeps every 5 seconds when the battery runs low (approximately 2 minutes remaining, but this is user configurable). The AC Input LED will extinguish, and the Battery LED will illuminate to warn that a mains problem has occurred. Each battery level indicator represents a 20% capacity level. As capacity decreases, fewer indicators remain illuminated. Refer to **12.0 - Troubleshooting**. For approximate battery run times, refer to **Table 6**. These times are approximate, based on resistive load and an ambient temperature of 25°C (77°F). To increase this time, turn off non-essential pieces of equipment (such as idle computers and monitors) or add the optional external battery cabinet.

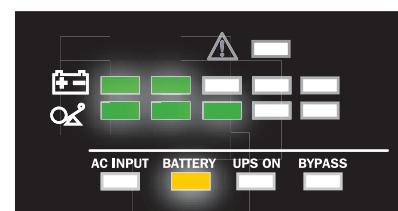

Battery Mode Operation
Batteries at 30% Charge
Load at 50%



CAUTION

Turning OFF the UPS while in it is battery mode will cut off output power.

9.3 Bypass Mode Operation

Bypass mode occurs when the OFF button is pressed once while the UPS is in Normal Mode. During bypass operation, mains power provides energy to the UPS. The mains power bypasses the inverter and provides power for the connected load.

The four green load level LEDs indicate an approximate level of load in 25% increments. If the UPS becomes loaded beyond full rating, the fifth (amber) LED indicator will illuminate and the UPS will sound an audible alarm. The display template indicates the percentage of load (26-50% of load shown in the example above) on the UPS output.

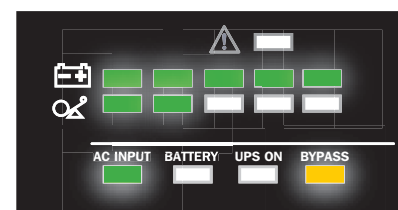

9.4 Battery Recharge Mode

Once mains power is restored, the UPS resumes normal operation. At this time, the Battery Charger begins recharging.

10.0 COMMUNICATIONS

10.1 Communications Interface Port

The S4K5U UPS has a standard DB-9 serial port female connector located on the rear of the UPS unit. Several signals are provided on this port and are assigned as follows:

Table 2 DB-9 pin assignment

DB-9 Pin	Assignment Description
1	Low Battery (open collector)
2	UPS TxD (typically RS-232 levels)
3	UPS RxD (typically RS-232 levels)
4	Remote Shutdown (5-12VDC, 10-24mA max; battery operation)
5	Common
6	Remote Shutdown (short to pin 5); all modes of operation
7	Low Battery (open emitter)
8	Mains Fail (open emitter)
9	Mains Fail (open collector)

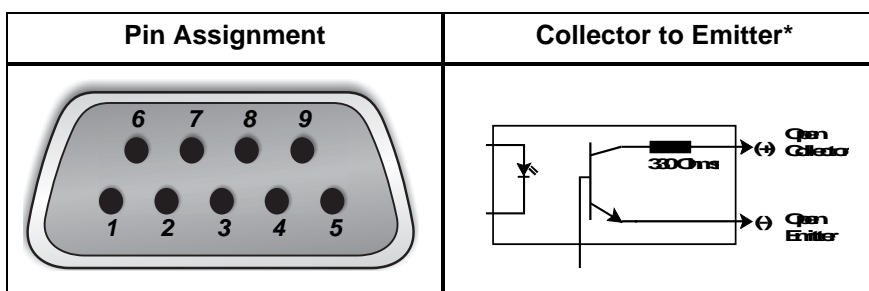

* Maximum voltage and current on pins 1, 7, 8 and 9 are 60VDC and 10.0 mA

10.2 Pin 4 - Remote Shutdown on Battery

1. This pin is functional only when the UPS is in battery mode. If the UPS is being powered by the mains, Pin 4 will ignore any signal on this pin.
2. Pin 4 requires a 5-12 VDC signal to shutdown. This normally comes from the serial port using Sola/Hevi-Duty's contact closure cable. It cannot be used with just a contact closure unless the relay is used to switch a voltage source. A 5-12 VDC signal for 1.5 seconds or greater is required to signal a shutdown. Signals for less than 1.5 seconds will be ignored. After Pin 4 receives a shutdown signal for 1.5 seconds, the command cannot be canceled.
3. A battery shutdown signal on Pin 4 will NOT cause an immediate Shutdown. A shutdown signal will start a 2-minute shutdown timer. The timer cannot be stopped. After 2 minutes, the UPS will shut down.
4. If the mains returns during the 2-minute timer countdown, the shutdown timer will continue until the end of 2 minutes and the UPS will turn OFF. The UPS must remain OFF for at least 10 seconds even if AC input power Returns before the UPS turns OFF. This serves to reset and restart the server.

Whether the UPS turns back ON when power is restored depends on the auto-restart setting: enabled or disabled.

If the auto-restart is disabled, the UPS will not restart after performing the 2-minute shutdown delay.

10.3 UPS Intelligent Communications

The S4K5U is equipped with two Intellislot® ports to provide advanced communication and monitoring options.

The Intellislot port closer to the corner of the UPS chassis is the serial card slot. This Intellislot port is used for the SNMP WEB CARD. The other Intellislot port is used for RELAY CARD-INT or the MULTIPOINT4CARD.

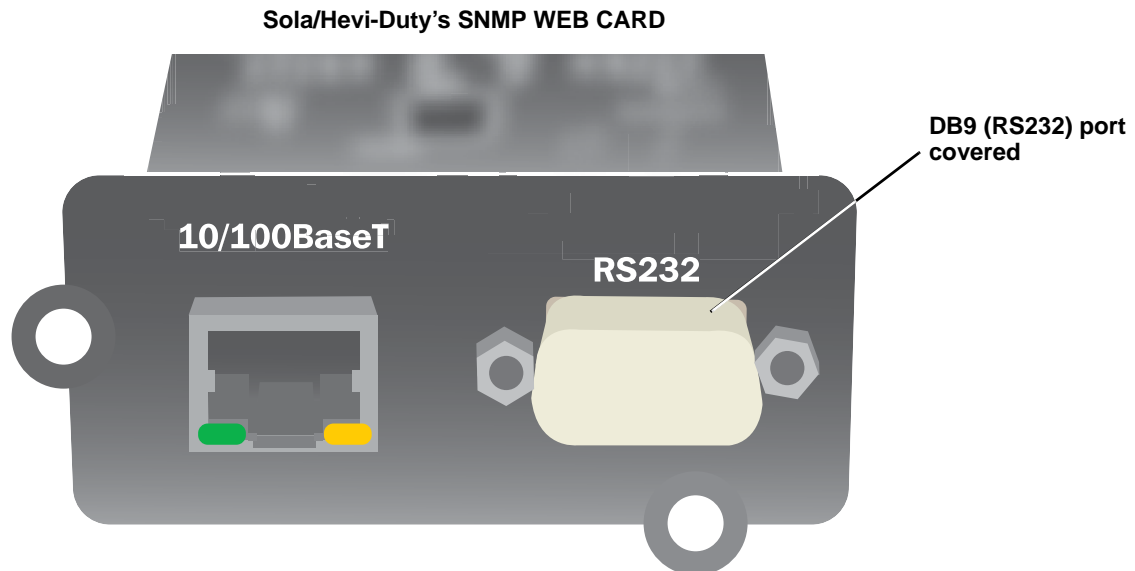

NOTE

The SNMP WEB CARD serial port cable should be used only for the initial card setup. Remove the cable after setup is complete.

When the DB9 serial port cable is removed, the SNMP WEB CARD DB9 connector needs to be covered. The DB9 cover is included with the UPS.

Sola/Hevi-Duty's MultiLink software continually monitors the UPS and can shut down your computer or server in the event of an extended power failure.

MultiLink can also be configured for use without the serial cable when the Intellislot) SNMP WEB CARD is installed in the UPS. Additionally, MultiLink can be configured to coordinate shutdown across the network with other computers running MultiLink when you purchase a MultiLink License Kit. For more information about the Intellislot SNMP WEB CARD and MultiLink license Kits, visit our Web site (www.Sola/Hevi-Duty.com) or contact your local dealer or Sola/Hevi-Duty representative.

Several option cards are available for use in the Intellislot port of the S4K5U. The Intellislot SNMP WEB CARD provides SNMP and Web-based monitoring and control of the UPS across the network.

The Intellislot MULTIPOINT4CARD allows you to install MultiLink software on four computers and coordinate shutdown in the event of a power failure.

The Intellislot RELAY CARD-INT provides dry contact relay outputs for custom wired applications and delivers support for built-in shutdown for AS/400 systems.



CAUTION

To maintain safety (SELV) barriers and for electromagnetic compatibility, signal cables should be segregated and run separate from all other power cables, where applicable.

10.4 Remote Emergency Power Off

The UPS is equipped with a Remote Emergency Power Off (REPO) connector.

The user must supply a means of interfacing with the REPO circuit to allow disconnecting the UPS input feeder breaker to remove all sources of power to the UPS and connected equipment to comply with national and local wiring codes and regulations.

REPO switch connection diagram

UPS ships with REPO jumper installed allowing the UPS to operate

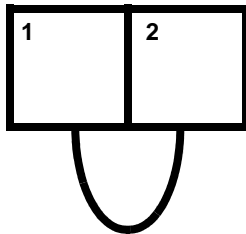

Normally closed switch system
(fail-safe)

Opening the REPO connection will disable the UPS. Manual restart using the front panel is required after the REPO connection is closed again.

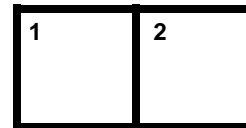

CAUTION

To maintain safety (SELV) barriers and electromagnetic compatibility, signal cables should be segregated and run separately from power cables.

11.0 MAINTENANCE

11.1 Internal Battery

The S4K5U requires very little maintenance. The batteries are valve-regulated, non-spillable, flame retardant, lead acid, and should be kept charged to obtain their designed life. The UPS continuously charges the batteries when connected to the mains supply.

When storing the UPS for any length of time, it is essential to plug the UPS in for at least 24 hours every four to six months to ensure full recharge of the batteries. Failure to recharge the batteries periodically will result in permanent degradation of battery capacity.

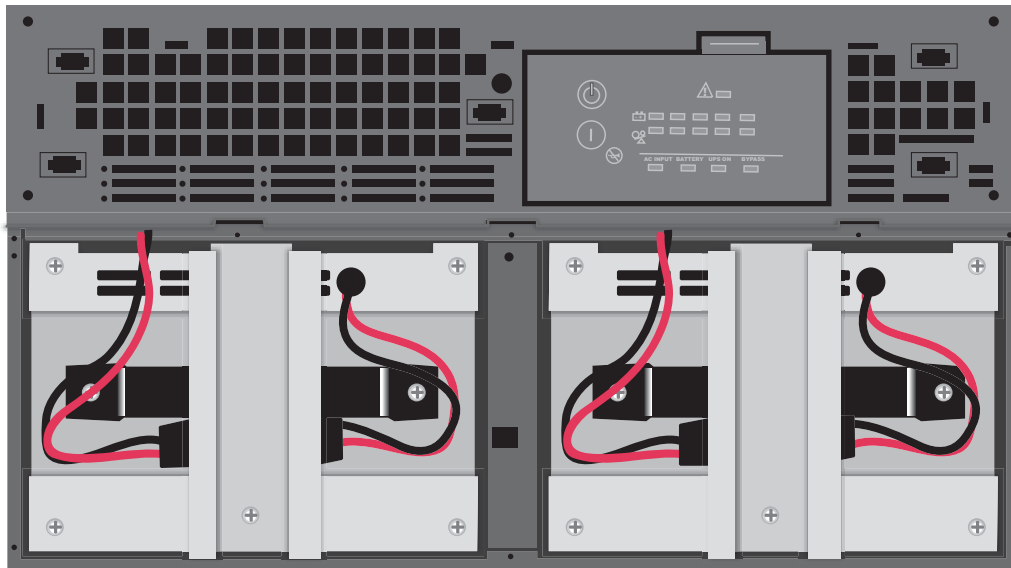

The S4K5U is designed to allow the user to safely replace the internal batteries. Read the safety cautions before proceeding. Contact your local dealer or Sola/Hevi-Duty representative to obtain the appropriate replacement battery kit part number and pricing.

11.1.1 Internal Battery Replacement



CAUTION

A battery can present a risk of electrical shock and high short circuit current. Observe the following precautions before replacing the batteries:

- Remove rings, watches and other metal objects.
- Use a Phillips (cross-head) screwdriver with insulated grips.
- Do not lay tools or other metal objects on top of the batteries.
- If the battery replacement kit is damaged in any way or shows signs of leakage, contact your local dealer or Sola/Hevi-Duty representative immediately.
- Do not dispose of batteries in a fire. The batteries may explode.
- Do not open or mutilate batteries. Released electrolyte is harmful to the skin and eyes. It is toxic.



VORSICHT

Bei einer Batterie ist das Risiko eines Stromschlags und eines starken Kurzschlussstroms gegeben. Beachten Sie folgende Vorsichtshinweise, bevor Sie die Batterien ersetzen.

- Ringe, Armbanduhren und sonstige Metallobjekte sind zu entfernen.
- Verwenden Sie einen Kreuzschlitzschraubendreher mit isoliertem Griff.
- Legen Sie keine Werkzeuge oder sonstige Metallgegenstände oben auf die Batterien.
- Wenn der als Ersatz gedachte Batteriesatz in irgendeiner Weise beschädigt ist oder Leckagen aufweist, wenden Sie sich umgehend an Ihren örtlichen Händler oder Sola/Hevi-Duty-Vertreter.
- Batterien dürfen auf keinen Fall verbrannt werden. Die Batterien könnten dabei explodieren.
- Die Batterien dürfen nicht geöffnet oder zerstört werden. Die austretende Füllsäure ist schädlich für Haut und Augen. Sie ist giftig.

1. Remove the 5U bezel panel on the front of the UPS by removing the screws located on the sides of the bezel (see illustration at right).
2. Remove battery access door by loosening the captive screws and tipping the panel forward. Lift to remove it from the main cabinet.
3. Use a Phillips (cross-head) screwdriver to remove the screw in the battery retaining bracket on each battery pack (see illustration at right). Remove the retaining brackets.
4. Disconnect the battery connectors in the front of each battery pack.
5. Lift the internal connector out of the way and slide the battery out of the UPS. Support the weight of the battery to prevent it from falling.
6. Unpack the new battery assembly, taking care not to destroy the packing. Compare new and old battery assemblies to make sure they are the same. If so, proceed with **Step 7**; otherwise STOP and contact your local dealer, Sola/Hevi-Duty representative or the Sola/Hevi-Duty Technical Support Services.
7. Line up and slide in the new replacement battery pack while holding the internal connector out of the way.
8. Reconnect the electrical connections for each battery pack.
9. Install the battery retaining brackets using the Phillips removed earlier.
10. Install the battery access panel and tighten the captive screws.

**NOTE**

These are hot-swappable replacement batteries. However, caution should be exercised because during this procedure the load is unprotected from disturbances and power outages.

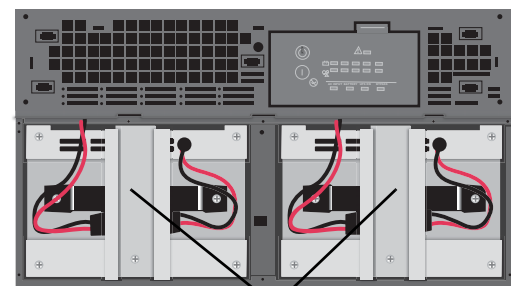
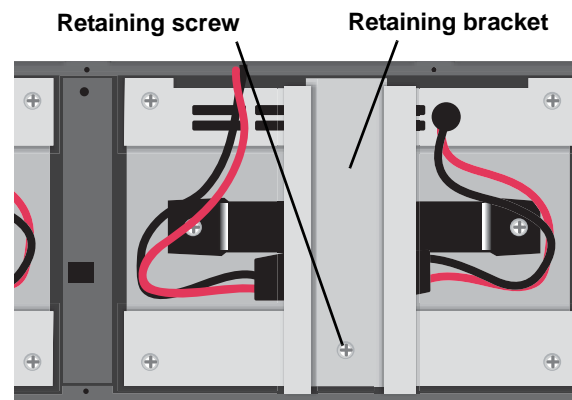
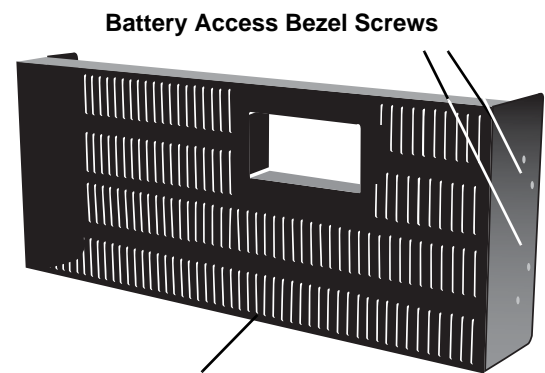

11.2 AC Power Connections

Power connections may be disconnected from the UPS cabinet via a removable distribution box. This may be a convenient feature if the UPS must be moved a short distance or replaced. This box allows power connections to be conveniently disconnected from the main UPS cabinet. A label is attached to the UPS to describe these procedures.

Hardwire and Hardwire/Receptacle boxes that include a Manual Bypass Switch allow AC power to continue to flow from the mains input to the load while the box is removed from the UPS.

11.2.1 S4KPAD-CEHW-MBS - Manual Bypass Switch

Disconnect

1. DO NOT turn off the branch circuit breaker feeding power the box unless you intend to disconnect all power to the load.
2. Ensure that the Maintenance Bypass Lamp is ON.
3. Switch to the maintenance bypass position.
The Load is now unprotected from line disturbances or interruptions.
4. Turn off the UPS using the front panel controls.
 - a. If needed, push the OFF button for one second once to transfer the load to bypass.
 - b. Press the OFF button twice within four seconds to turn the UPS off.
5. Turn off the UPS input circuit breaker on the box at the rear of the UPS.
This input circuit breaker only cuts power to the connector between the box and UPS. The input circuit breaker does not cut power to the manual bypass switch.
6. Turn off the output circuit breaker on the rear of the UPS.
7. Remove the distribution box from the UPS
 - a. Loosen all three captive screws until box releases.
 - b. Pull box away from the UPS and set the box aside on a padded surface.



CAUTION

Power is still passing through the box from mains to the load.



VORSICHT

Es fließt noch Netzstrom durch den Kasten zu den angeschlossenen Geräten.

Reconnect

1. Align connectors and press the box onto the rear of the UPS.
2. Hold the box firmly against the UPS and tighten the captive screws. Do not overtighten.
3. If the Mains branch circuit breaker and load is off, turn the branch breaker on now.
4. Turn on the output circuit breaker on the rear of the UPS.
5. Turn on the input circuit breaker on the box.
6. Start the UPS according to the startup instructions.
Press the ON button for one second.
7. Confirm that the UPS AVAILABLE lamp is lit beside the manual bypass switch.
8. Turn the manual bypass switch to the UPS position.
9. The UPS now protects the load.

12.0 TROUBLESHOOTING

The information below indicates various symptoms a user may encounter in the event the S4K5U develops a problem. Use this information to determine whether external factors caused the problem and how to remedy the situation.

1. 1. The Fault indicator will illuminate, indicating the UPS detected a problem.
2. 2. An alarm will sound, alerting that the UPS requires attention.

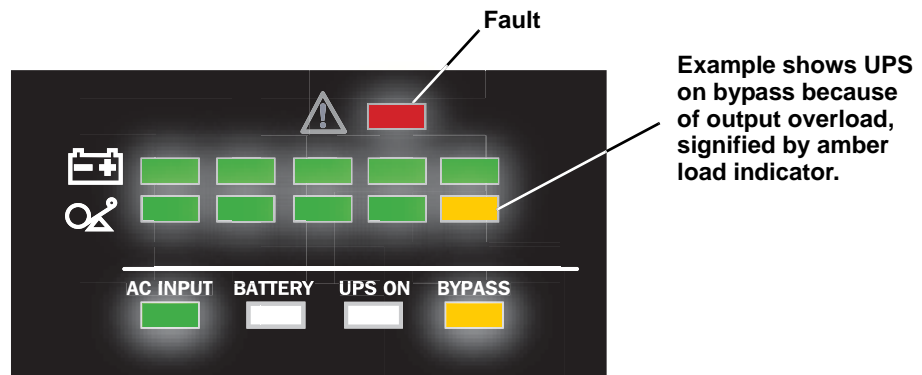

3. 3. One or more additional battery level LED indicators will be illuminated to provide a diagnostic aid to the operator, as described below:

Table 3 Indicator meanings

LED status	Diagnosis/Audible alarm
All LEDs	On bypass due to output overload; beep every half-second
A LED	On bypass due to overtemperature condition; beep every 4 sec.
B LED	On bypass due to DC bus overvoltage; beep every 4 sec.
C LED	DC-DC failure during battery mode; beep every 4 sec.
D LED	On bypass due to PFC failure; beep every 4 sec.
E LED	On bypass due to inverter failure; beep every 4 sec.
A&C LEDs	UPS failed battery test; long beep every minute
C&E LEDs	UPS shutdown due to command from communication port (SNMP); no beep
Battery LED Flashing	Internal Battery source not available (continuous horn). Check Battery connection, completely power down and reboot UPS.
A&E LEDs	Fan locked
B&C	REPO active. UPS cannot run with REPO loop open.
B&D	UPS is OFF due to previous REPO shutdown. Autorestart disabled.
D&E	Charger Malfunction

Under fault conditions, the Fault indicators will be illuminated indefinitely while battery charger is operational, or for a maximum of 5 minutes while the battery charger is not operational.

If a problem persists, consult your local dealer, Sola/Hevi-Duty representative or contact the Sola/Hevi-Duty Technical Support Services. Please have the UPS model number and serial number available at the time of your inquiry.

Table 4 Troubleshooting guide

Problem	Cause	Solution
UPS fails to start when the ON button is pressed.	UPS is short-circuited or overloaded.	Ensure UPS is OFF. Disconnect all loads and ensure nothing is lodged in output receptacles. Ensure loads are not defective or shorted internally.
Battery indicator LED is illuminated.	UPS not plugged in.	UPS is operating from battery mode, make certain UPS is securely plugged into the wall receptacle.
	UPS input protection fuse has blown/opened.	UPS is operating from battery mode. Save data and close applications. Replace UPS input fuse, then restart UPS.
	Mains voltage out of UPS input range.	UPS is operating from battery mode. Save data and close applications. Ensure mains supply voltage is within acceptable limits for UPS.
UPS has reduced battery time.	Batteries are not fully charged.	Keep UPS plugged in continuously at least 24 hours to recharge batteries.
	UPS is overloaded.	Check load level display and reduce the load on the UPS.
	Batteries may not be able to hold a full charge due to age.	Replace batteries. Contact your local dealer, Sola/Hevi-Duty representative or the Sola/Hevi-Duty Technical Support Services for replacement battery kit.
Fault and Bypass indicator LEDs and all load level LEDs are illuminated.	UPS overloaded or load equipment is faulty.	Check load level display and remove non-essential loads. Recalculate the load and reduce number of loads connected to UPS. Check load equipment for faults.
Fault and Bypass indicator LEDs and diagnostic LED A are illuminated.	UPS internal fan has a problem or UPS shutdown due to temperature condition. Load is on bypass power.	Ensure UPS is not overloaded, ventilation openings not blocked, or room ambient temperature is not excessive. Wait 30 minutes to allow UPS to cool, then restart UPS. If UPS does not restart, contact your local dealer, Sola/Hevi-Duty representative or the Sola/Hevi-Duty Technical Support Services.
Fault and Bypass indicator LEDs and diagnostic LED B are illuminated.	UPS internal DC bus overvoltage.	UPS requires service. Contact your local dealer, Sola/Hevi-Duty representative or the Sola/Hevi-Duty Technical Support Services.
Fault indicator LED and diagnostic LED C are illuminated.	DC-DC failure during battery mode.	Bus voltage under 315VDC(O/P 220VAC) / 330VDC(O/P 230VAC) / 345VDC(O/P 240VAC). UPS requires service. Contact your local dealer, Sola/Hevi-Duty representative or the Sola/Hevi-Duty Technical Support Services.
Fault and Bypass indicator LEDs and diagnostic LED D are illuminated.	UPS PFC (Power Factor Correction Circuit) fault.	UPS requires service. Contact your local dealer, Sola/Hevi-Duty representative or the Sola/Hevi-Duty Technical Support Services.
Fault and Bypass indicator LEDs and diagnostic LED E are illuminated.	UPS inverter fault.	UPS requires service. Contact your local dealer, Sola/Hevi-Duty Representative or the Sola/Hevi-Duty Technical Support Services.
Fault indicator LED and diagnostic LEDs A and C are illuminated.	UPS failed the battery test.	Replace batteries. Contact your local dealer, Sola/Hevi-Duty representative or the Sola/Hevi-Duty Technical Support Services.
Fault and Bypass indicator LEDs and diagnostic LED C and E are illuminated.	UPS shutdown due to a command from the communications port(s).	Your UPS has received a signal or command from the attached computer. If this was inadvertent, ensure the communication cable used is correct for your system. For assistance, contact your local dealer, Sola/Hevi-Duty representative or the Sola/Hevi-Duty Technical Support Services.
Fault and LEDs A&E are illuminated	Fan locked	Check for external obstruction entering fan guard. UPS requires service. Contact your local dealer, Sola/Hevi-Duty representative or Sola/Hevi-Duty Technical Support Services.
Fault and LEDs B&C are illuminated	REPO active	circuit is closed. If not used, a wire jumper must connect the REPO terminals.
Fault and LEDs B&D are illuminated	UPS is OFF due to previous REPO shutdown, but the REPO has been connected or reset. Autorestart disabled.	Start the UPS using the front panel.

Table 4 Troubleshooting guide (cont'd)

Problem	Cause	Solution
Fault and LEDs D&E are illuminated	Charger malfunction	If the charger is overvoltage, the UPS will shutdown. If the charger is undervoltage and the batteries are nearly depleted, this alarm will give a temporary warning before the UPS shuts down. UPS requires service. Contact your local dealer, Sola/Hevi-Duty representative or Sola/Hevi-Duty Technical Support Services.
Battery LED is flashing.	Battery source is not available; continuous horn.	Check battery connections, completely power down and restart UPS. NOTE: If the battery circuit opens while the UPS is running, it will be detected when the next battery test is performed.

Table 5 Alarm conditions

Condition	Alarm
Battery Mode (mains failure)	One short beep every 10 seconds: more than 2 minutes of run time remaining
Low Battery	Two short beeps every 5 seconds: less than 2 minutes of run time remaining
Output Overload (Bypass)	One short beep every half second
Overtemperature (Bypass)	A one-second beep every 4 seconds
DC Bus Overvoltage (Bypass)	A one-second beep every 4 seconds
DC-DC failure during battery mode	A one-second beep every 4 seconds
PFC Failure (Bypass)	A one-second beep every 4 seconds
Inverter Failure	A one-second beep every 4 seconds
Battery Test Failure	A two-second beep every 1 minute
Fan Locked	A one-second beep every 4 seconds
REPO Active	A 0.25-second beep every 0.25 seconds
UPS OFF; Autorestart disabled from previous REPO shutdown	A one-second beep every 4 seconds
Charger Malfunction	A one-second beep every 4 seconds

Table 6 Battery run times

	Load%	4500VA	6000VA
Internal Battery (minutes)	10%	125	94
	20%	66	46
	30%	41	29
	40%	30	21
	50%	24	17
	60%	19	13
	70%	16	11
	80%	14	9
	90%	12	8
	100%	10	7
Internal Battery + 1 External Battery Cabinet (minutes)	10%	296	222
	20%	166	124
	30%	114	81
	40%	86	60
	50%	70	49
	60%	56	39
	70%	48	33
	80%	41	28
	90%	35	24
	100%	31	21
Internal Battery + 2 External Battery Cabinets (minutes)	10%	467	350
	20%	262	197
	30%	180	135
	40%	142	105
	50%	120	85
	60%	98	70
	70%	83	58
	80%	72	50
	90%	62	43
	100%	54	38
Internal Battery + 3 External Battery Cabinets (minutes)	10%	638	478
	20%	358	269
	30%	247	185
	40%	193	145
	50%	164	123
	60%	138	101
	70%	120	85
	80%	104	73
	90%	90	63
	100%	80	55
Internal Battery + 4 External Battery Cabinets (minutes)	10%	809	606
	20%	454	341
	30%	313	235
	40%	245	184
	50%	208	156
	60%	175	131
	70%	153	113
	80%	135	97
	90%	120	85
	100%	106	75

Using the configuration program, the user may specify the number of external battery cabinets attached to the UPS. The factory default is programmed for internal batteries only.

Table 6 above shows the estimated run times at different loads.

12.0.1 Auto-Learning Battery Run Times

As batteries age, the estimated runtimes may become less accurate. The S4K5U is programmed to “learn” from a full battery discharge and modify the estimated runtime for the measured battery capacity. This can improve accuracy and compensate for aging batteries or batteries that operate at different ambient temperatures.

The UPS will update the anticipated run time calculation only under certain conditions.

- The UPS must have a steady load that is greater than 20%.
- The UPS must be at 100% charge at the start of a battery discharge.
- The battery discharge must continue uninterrupted until the batteries reach their end-of-discharge voltage.

If all conditions are not met, the run time calculation will not be modified.

If the configuration program is used to change the number of battery cabinets, then the values in the battery above table will be restored. This will override any value that is Auto-Learned.

13.0 SPECIFICATIONS (SECHNISCHE DATEN)

Table 7 UPS specifications

Model Number	S4K5U6000-5	S4K5U4500-5
Model Rating	6KVA / 4,200W	4.5KVA / 3,150W
Dimensions mm (in.)		
Unit, W x D x H	221 x 547 x 430 (8.7 x 21.5 x 16.9)	
Shipping, W x D x H	560 x 690 x 500 (22.05 x 27.17 x 19.7)	
Weight kg (lbs)		
Unit	67 (151)	67 (151)
Shipping	79.5 (175.3)	79.5 (175.3)
Input AC Parameters		
Nominal Operating Frequency	50 or 60Hz (Factory Default = 50)	
Factory Default VAC	230VAC	
User Configurable VAC	220/230/240VAC (May be modified using configuration program)	
Operating Voltage Range Without Battery Operation	176 – 276VAC	
Maximum Allowable VAC	276VAC	
Input Frequency Without Battery Operation	40 - 70Hz	
Input Power Connection	(See 3.3 - Removable Power Distribution Box)	
Output AC Parameters		
Factory Default VAC	230VAC	
Output Connections	(See 3.3 - Removable Power Distribution Box)	
Frequency	50Hz or 60Hz, Nominal	
Waveform	Sinewave	
Main Mode Overload	>200% for 96 milliseconds; 131 - 199% for 2 seconds; 112- 129% for 10 seconds with transfer to bypass	
Battery Parameters		
Type	Valve-regulated, non-spillable, lead acid	
Quantity x V	20 x 12V	
Battery Mfr. / Part #	Yuasa / REW 28-12	
Back-up Time	See Table 6 - Battery run times	
Recharge Time (Internal Batteries)	3 hrs. to 90% capacity after full discharge into 100% load	
Bypass Protection Limits		
Disable Bypass operation	If input voltage exceeds $\pm 15\%$ of the nominal voltage	
Re-enable Bypass operation	If input voltage returns to within $\pm 10\%$ of nominal output voltage	
Disable Bypass operation	When the input frequency prevents synchronous operation	
Environmental		
Operating Temperature	0°C to +40°C (+32°F to +104° F)	
Storage Temperature	-15°C to +50°C (+5°F to +122° F)	
Relative Humidity	0-95% non-condensing	
Operating Elevation	Up to 2000m (6600 ft) at 40°C (104° F) without derating	
Storage Elevation	15,000m (50,000 ft.) maximum	
Audible Noise	<55 dBA, at 1 meter from the rear <50 dBA, at 1 meter from the front or sides	
Agency		
Safety	EN62040-1-1; TUV/GS	
EMI/EMC/C-Tick EMC	EN50091-2 and AS 62040-2: 2002, Class A; CE EMC Directive	
ESD	EN61000-4-2, Level 4, Criteria A	
Radiated Susceptibility	EN61000-4-3, Level 3, Criteria A	
Electrical Fast Transient	EN61000-4-4, Level 4, Criteria A	
Surge Immunity	EN61000-4-5, Level 3, Criteria A	
Transportation	ISTA Procedure 1B	

Table 8 Power distribution specifications

Model Number	S4KPAD-CEHW	S4KPAD-CEHW-MBS
Amps Rating	32 Amps	
Input Power Connection	3-Wire Hardwired, 6-10mm ² (8-10AWG)	
Output Power Connection	3-Wire Hardwired, 6-10mm ² (8-10AWG)	
Includes:	Two IEC320 C19 16A/250V sockets	Two IEC320 C19 16A/250V sockets Manual Bypass Switch with Indicator Lamps
Input Branch Circuit Breaker	32A, Supplied by User	

Table 9 External battery cabinet specifications

Model Number	S4K240BAT
Used w/ UPS model	S4K5U6000-5, S4K5U4500-5
Dimensions, W x D x H, mm (in.)	
Unit (with bezel)	176 x 522 x 430 (6.9 x 20.55 x 16.9)
Shipping	560 x 690 x 455 (22 x 27.2 x 17.9)
Weight, kg (lbs)	
Unit	65 (145)
Shipping	78.5 (173.1)
Battery Parameters	
Type	Valve-regulated, non-spillable, flame retardant, lead acid
Qty x V	20 x 12V
Battery Manufacturer, Part #	Yuasa / REW 45-12
Backup Time	See Battery Run Times charts
Environmental	
Operating Temp	0°C to +40°C (+32°F to +104° F)
Storage Temp	-15°C to +50°C (+5°F to +122° F)
Relative Humidity	0-95% non-condensing
Operating Elevation	Up to 2000m (6600 ft.) at 40°C (104° F) without derating
Storage Elevation	15,000m (50,000 ft.) maximum
Agency	
Safety	EN62040-1-1; TUV/GS
Transportation	ISTA Procedure 1B

Tabelle 10 Technische Daten zur USV

Modellnummer	S4K5U6000-5	S4K5U4500-5
Modell-Nennleistung	6 KVA / 4.200 W	4,5 KVA / 3.150 W
Abmessungen in mm (in.)		
Gerät, B x T x H	221 x 547 x 430 (8,7 x 21,5 x 16,9)	
Versand, B x T x H	560 x 690 x 500 (22,05 x 27,17 x 19,7)	
Gewicht kg (lbs)		
Gerät	67 (151)	67 (151)
Versand	79,5 (175,3)	79,5 (175,3)
Eingangs-Wechselstromparameter		
Betriebsnennfrequenz	50 oder 60 Hz (Standardeinstellung ab Werk = 50)	
Standardeinstellung ab Werk, V AC	230 V AC	
V AC, vom Benutzer konfigurierbar	220/230/240 V AC (Kann mithilfe des Konfigurationsprogramms modifiziert werden)	

Tabelle 10 Technische Daten zur USV

Modellnummer	S4K5U6000-5	S4K5U4500-5
Betriebsspannungsbereich ohne Batteriebetrieb	176 – 276 V AC	
Maximal zulässiger V AC-Wert	276 V AC	
Eingangsfrequenz ohne Batteriebetrieb	40 - 70 Hz	
Eingangsleistungsanschluss	(Siehe 3.3 - Removable Power Distribution Box)	
Ausgangs-Wechselstromparameter		
Standardeinstellung ab Werk, V AC	230 V AC	
Ausgangsanschlüsse	(Siehe 3.3 - Removable Power Distribution Box)	
Frequenz	50 Hz oder 60 Hz, Nennwert	
Wellenform	Sinuswelle	
Hauptmodusüberlast	>200 % 96 Millisekunden lang; 131 – 199 % 2 Sekunden lang; 112- 129 % 10 Sekunden lang mit Umschaltung auf Bypass	
Batterieparameter		
Typ	Verschlossen, säuredicht, bleisäurehaltig	
Anzahl x V	20 x 12 V	
Batteriehersteller /Teilenr.	Yuasa / REW 28-12	
Sicherungszeit	Siehe Table 6 - Battery run times	
Wiederaufladezeit (interne Batterien)	3 Stunden bis 90 % Kapazität nach voller Entladung bei 100 % Last	
Bypass-Schutzgrenzen		
Bypass-Betrieb deaktivieren	Wenn die Eingangsspannung ± 15 % der Nennspannung überschreitet	
Bypass-Betrieb wieder aktivieren	Wenn die Eingangsspannung zu innerhalb von ± 10 % der Ausgangsnennspannung zurückkehrt	
Bypass-Betrieb deaktivieren	Wenn die Eingangsfrequenz einen synchronen Betrieb verhindert	
Umgebung		
Betriebstemperatur	0°C bis +40°C (+32°F bis +104° F)	
Lagertemperatur	-15°C bis +50°C (+5°F bis +122° F)	
Relative Luftfeuchtigkeit	0-95 %, keine Betauung	
Betriebshöhe	Bis zu 2000 m (6600 ft) bei 40°C (104°F) ohne Leistungsminderung max. 15.000 m (50.000 ft)	
Lagerhöhe		
Geräusch	<55 dBA, bei 1 m von der Rückseite <50 dBA, bei 1 m von vorne oder der Seite	
Behörden		
Sicherheit	EN62040-1-1; TÜV/GS	
EMI/EMC/C-Tick EMC	EN50091-2 und AS 62040-2: 2002, Klasse A; CE EMC-Richtlinie	
ESD	EN61000-4-2, Level 4, Kriterium A	
Störempfindlichkeit	EN61000-4-3, Level 3, Kriterium A	
Schnelle Transienten	EN61000-4-4, Level 4, Kriterium	
Stoßwellenfestigkeit	EN61000-4-5, Level 3, Kriterium	
Transport	ISTA-Verfahren 1B	

Tabelle 11 Technische Daten zur Stromverteilung

Modellnummer	S4KPAD-CEHW	S4KPAD-CEHW-MBS
Ampere-Nennleistung	32 Amps	
Eingangsleistungsanschluss	Dreidrig, fest verdrahtet, 6-10mm ² (8-10AWG)	
Ausgangsleistungsanschluss	Dreidrig, fest verdrahtet, 6-10mm ² (8-10AWG)	
Enthält:	Zwei IEC320 C19 16 A/250 V Buchsen	Zwei IEC320 C19 16 A/250 V Buchsen Manueller Bypass-Schalter mit Anzeigelampen
Eingangsabzweigschalter	32 A, vom Benutzer bereitgestellt	

Tabelle 12 Technische Daten zum externen Batteriegehäuse

Modellnummer	S4K240BAT
Verwendet mit USV-Modell	S4K5U6000-5, S4K5U4500-5
Abmessungen, B x T x H, mm (in.)	
Gerät (mit Blende)	176 x 522 x 430 (6,9 x 20,55 x 16,9)
Versand	560 x 690 x 455 (22 x 27,2 x 17,9)
Gewicht kg (lbs)	
Gerät	65 (145)
Versand	78,5 (173,1)
Batterieparameter	
Typ	Verschlossen, säuredicht, feuerhemmend, bleisäurehaltig
Anzahl x V	20 x 12V
Batteriehersteller /Teilenr.	Yuasa / REW 45-12
Sicherungszeit	Siehe Table 6 - Battery run times
Umgebung	
Betriebstemperatur	0°C bis +40°C (+32°F bis +104° F)
Lagertemperatur	-15°C bis +50°C (+5°F bis +122° F)
Relative Luftfeuchtigkeit	0-95 %, keine Betauung
Betriebshöhe	Bis zu 2000 m (6600 ft) bei 40°C (104°F) ohne Leistungsminderung
Lagerhöhe	max. 15.000 m (50.000 ft)
Behörden	
Sicherheit	EN62040-1-1; TÜV/GS
Transport	ISTA-Verfahren 1B



**SOLA/
HEVI-DUTY**

POWER AVAILABILITY

S4K5U6000-5

USER MANUAL

TECHNICAL SUPPORT

U.S.A.....(800) 377-4384

International.....(847) 268-6000

www.solaheviduty.com

While every precaution has been taken to ensure accuracy and completeness in this manual, Sola/Hevi-Duty assumes no responsibility, and disclaims all liability for damages resulting from use of this information or for any errors or omissions. © 2005 Sola/Hevi-Duty. All rights reserved throughout the world.

Specifications subject to change without notice.

® Sola/Hevi-Duty name and logo are registered trademarks of EGS Electrical Group, LLC. Intellislot is a registered trademark of Emerson Network Power. Multilink is a trademark of Emerson Network Power. All names referred to are trademarks or registered trademarks of their respective owners.

Rev. 1 (2/05) S4K5U6000-5