

HFA08TB60SPbF

Ultrafast, Soft Recovery Diode

Features

- Ultrafast Recovery
- Ultrasoft Recovery
- Very Low I_{RRM}
- Very Low Q_{rr}
- Specified at Operating Conditions
- Lead-Free

Benefits

- Reduced RFI and EMI
- Reduced Power Loss in Diode and Switching Transistor
- Higher Frequency Operation
- Reduced Snubbing
- Reduced Parts Count

Description

International Rectifier's HFA08TB60S is a state of the art ultra fast recovery diode. Employing the latest in epitaxial construction and advanced processing techniques it features a superb combination of characteristics which result in performance which is unsurpassed by any rectifier previously available. With basic ratings of 600 volts and 8 amps continuous current, the HFA08TB60S is especially well suited for use as the companion diode for IGBTs and MOSFETs. In addition to ultra fast recovery time, the HEXFRED product line features extremely low values of peak recovery current (I_{RRM}) and does not exhibit any tendency to "snap-off" during the t_b portion of recovery. The HEXFRED features combine to offer designers a rectifier with lower noise and significantly lower switching losses in both the diode and the switching transistor. These HEXFRED advantages can help to significantly reduce snubbing, component count and heatsink sizes. The HEXFRED HFA08TB60S is ideally suited for applications in power supplies (PFC Boost diode) and power conversion systems (such as inverters), motor drives, and many other similar applications where high speed, high efficiency is needed.

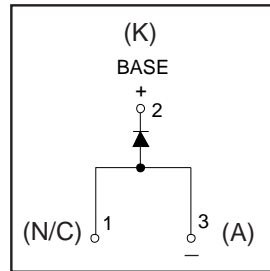

$V_R = 600V$
$V_F(\text{typ.})^* = 1.4V$
$I_{F(AV)} = 8.0A$
$Q_{rr}(\text{typ.}) = 65nC$
$I_{RRM} = 5.0A$
$t_{rr}(\text{typ.}) = 18ns$
$di_{(rec)M}/dt(\text{typ.}) = 240A/\mu s$

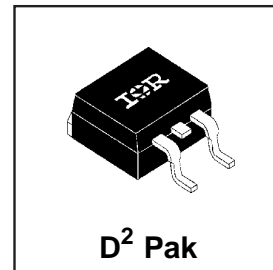

Absolute Maximum Ratings

	Parameter	Max.	Units
V_R	Cathode-to-Anode Voltage	600	V
$I_F @ T_C = 100^\circ C$	Continuous Forward Current	8.0	A
I_{FSM}	Single Pulse Forward Current	60	
I_{FRM}	Maximum Repetitive Forward Current	24	
$P_D @ T_C = 25^\circ C$	Maximum Power Dissipation	36	W
$P_D @ T_C = 100^\circ C$	Maximum Power Dissipation	14	
T_J	Operating Junction and	-55 to +150	$^\circ C$
T_{STG}	Storage Temperature Range		

* 125°C

www.irf.com

1

10/07/05

HFA08TB60SPbF

International
IRF Rectifier

Electrical Characteristics @ $T_J = 25^\circ\text{C}$ (unless otherwise specified)

	Parameter	Min.	Typ.	Max.	Units	Test Conditions
V_{BR}	Cathode Anode Breakdown Voltage	600	—	—	V	$I_R = 100\mu\text{A}$
V_{FM}	Max Forward Voltage	—	1.4	1.7	V	$I_F = 8.0\text{A}$
		—	1.7	2.1		$I_F = 16\text{A}$ See Fig. 1
		—	1.4	1.7		$I_F = 8.0\text{A}, T_J = 125^\circ\text{C}$
I_{RM}	Max Reverse Leakage Current	—	0.3	5.0	μA	$V_R = V_R \text{ Rated}$ See Fig. 2
		—	100	500		$T_J = 125^\circ\text{C}, V_R = 0.8 \times V_R \text{ Rated}$
C_T	Junction Capacitance	—	10	25	pF	$V_R = 200\text{V}$ See Fig. 3
L_S	Series Inductance	—	8.0	—	nH	Measured lead to lead 5mm from package body

Dynamic Recovery Characteristics @ $T_J = 25^\circ\text{C}$ (unless otherwise specified)

	Parameter	Min.	Typ.	Max.	Units	Test Conditions
t_{rr}	Reverse Recovery Time	—	18	—	ns	$I_F = 1.0\text{A}, di/dt = 200\text{A}/\mu\text{s}, V_R = 30\text{V}$
t_{rr1}	See Fig. 5, 6	—	37	55		$T_J = 25^\circ\text{C}$
t_{rr2}		—	55	90		$T_J = 125^\circ\text{C}$
I_{RRM1}	Peak Recovery Current	—	3.5	5.0	A	$T_J = 25^\circ\text{C}$
		—	4.5	8.0		$T_J = 125^\circ\text{C}$
I_{RRM2}		—	—	—		$V_R = 200\text{V}$
Q_{rr1}	Reverse Recovery Charge	—	65	138	nC	$T_J = 25^\circ\text{C}$
Q_{rr2}	See Fig. 7	—	124	360		$T_J = 125^\circ\text{C}$
$di_{(rec)M}/dt1$	Peak Rate of Fall of Recovery Current	—	240	—	A/ μs	$T_J = 25^\circ\text{C}$
$di_{(rec)M}/dt2$	During t_b See Fig. 8	—	210	—		$T_J = 125^\circ\text{C}$

Thermal - Mechanical Characteristics

	Parameter	Min.	Typ.	Max.	Units
$T_{\text{lead}} \text{ ①}$	Lead Temperature	—	—	300	$^\circ\text{C}$
R_{thJC}	Thermal Resistance, Junction to Case	—	—	3.5	K/W
$R_{\text{thJA}} \text{ ②}$	Thermal Resistance, Junction to Ambient	—	—	80	
Wt	Weight	—	2.0	—	g
		—	0.07	—	(oz)

① 0.063 in. from Case (1.6mm) for 10 sec

② Typical Socket Mount

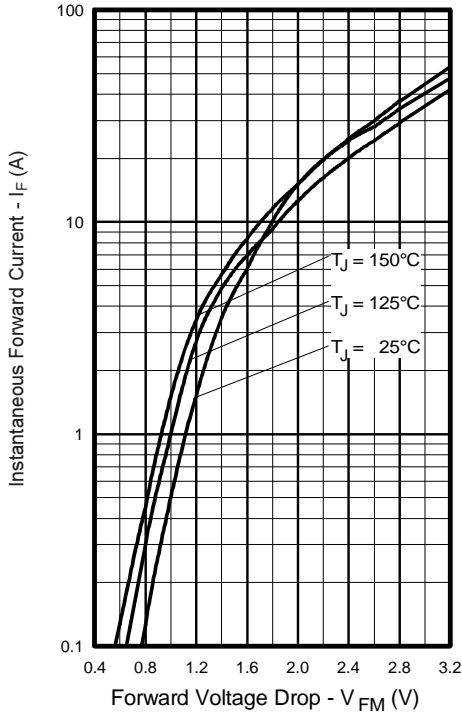

Fig. 1 - Maximum Forward Voltage Drop vs. Instantaneous Forward Current

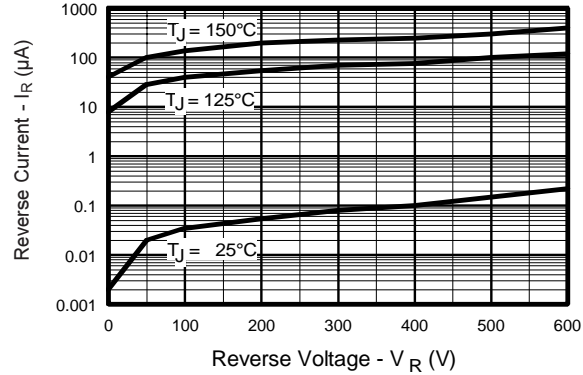

Fig. 2 - Typical Reverse Current vs. Reverse Voltage

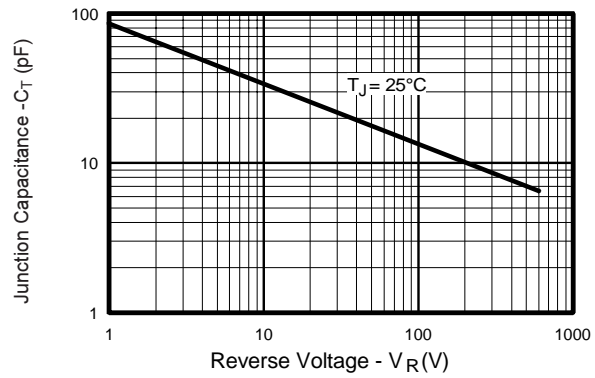

Fig. 3 - Typical Junction Capacitance vs. Reverse Voltage

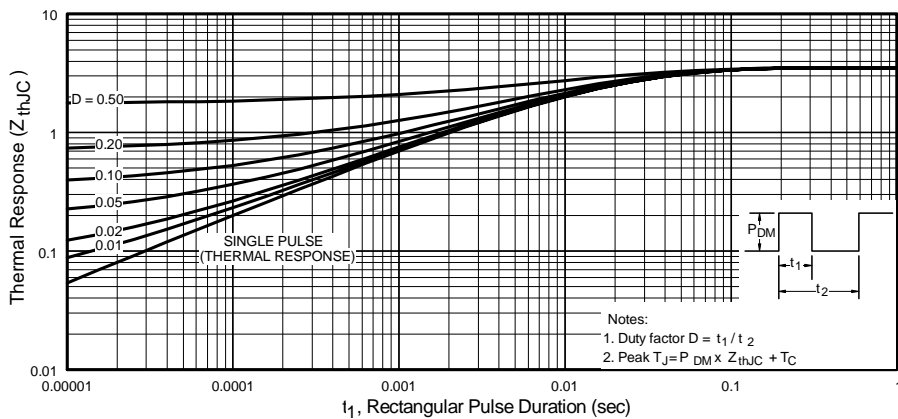

Fig. 4 - Maximum Thermal Impedance Z_{thJC} Characteristics

HFA08TB60SPbF

International
IR Rectifier

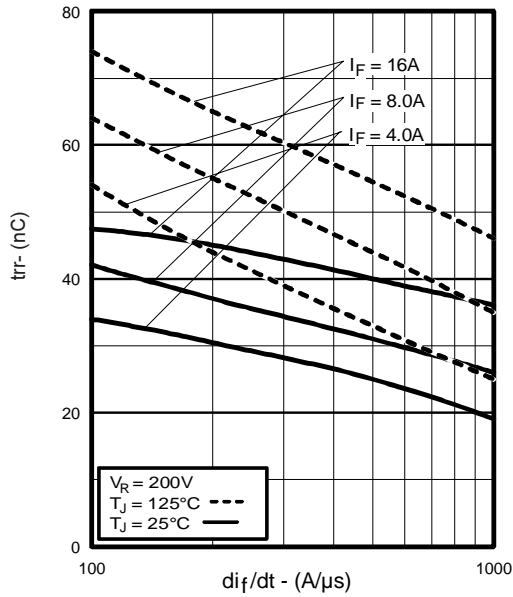

Fig. 5 - Typical Reverse Recovery vs. di_f/dt

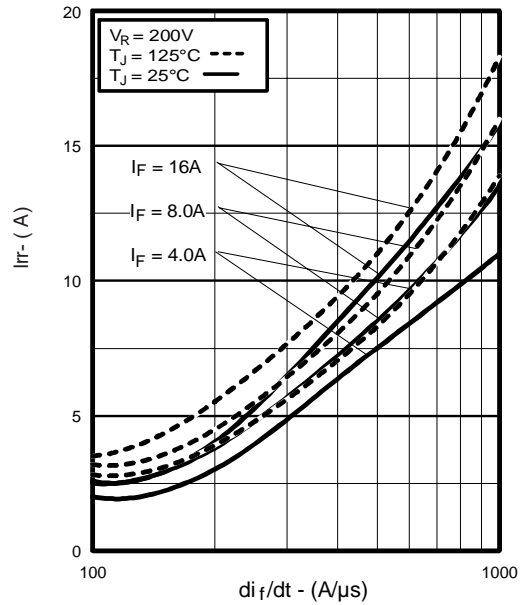

Fig. 6 - Typical Recovery Current vs. di_f/dt

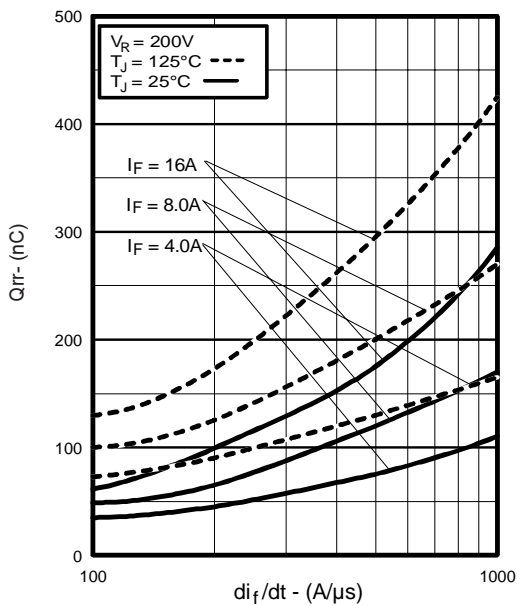

Fig. 7 - Typical Stored Charge vs. di_f/dt

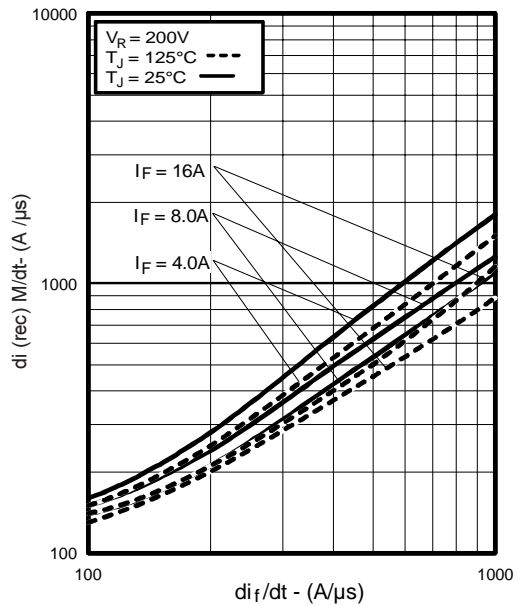

Fig. 8 - Typical $di_{(rec)M}/dt$ vs. di_f/dt

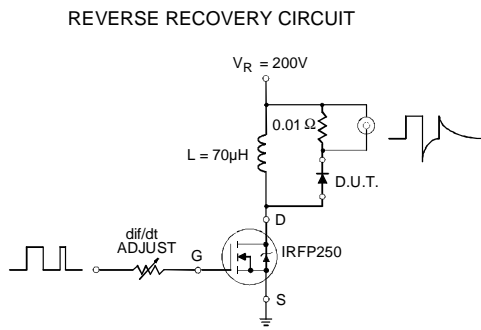

Fig. 9 - Reverse Recovery Parameter Test Circuit

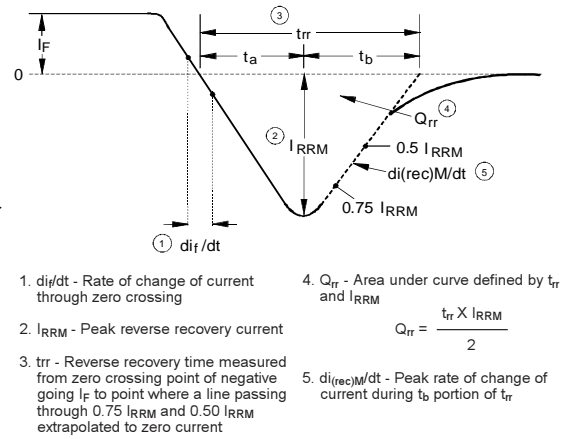

Fig. 10 - Reverse Recovery Waveform and Definitions

HFA08TB60SPbF

International
IR Rectifier

D²PAK Package Outline

Dimensions are shown in millimeters (inches)

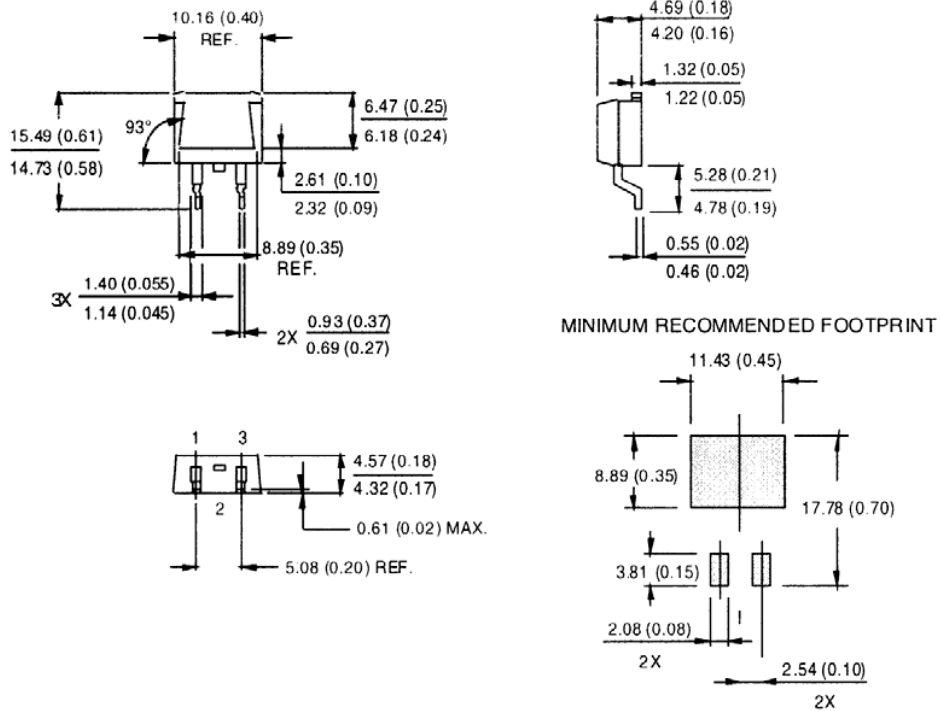

Conforms to JEDEC Outline D²PAK
Dimensions in millimeters and inches

D²PAK Part Marking Information

EXAMPLE: THIS IS A HFA08TB60S

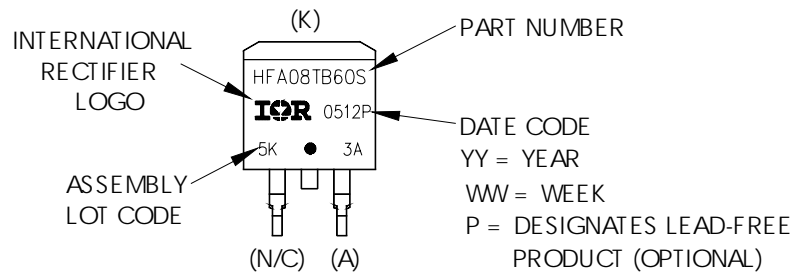

D²PAK Tape & Reel Information

Dimensions are shown in millimeters (inches)

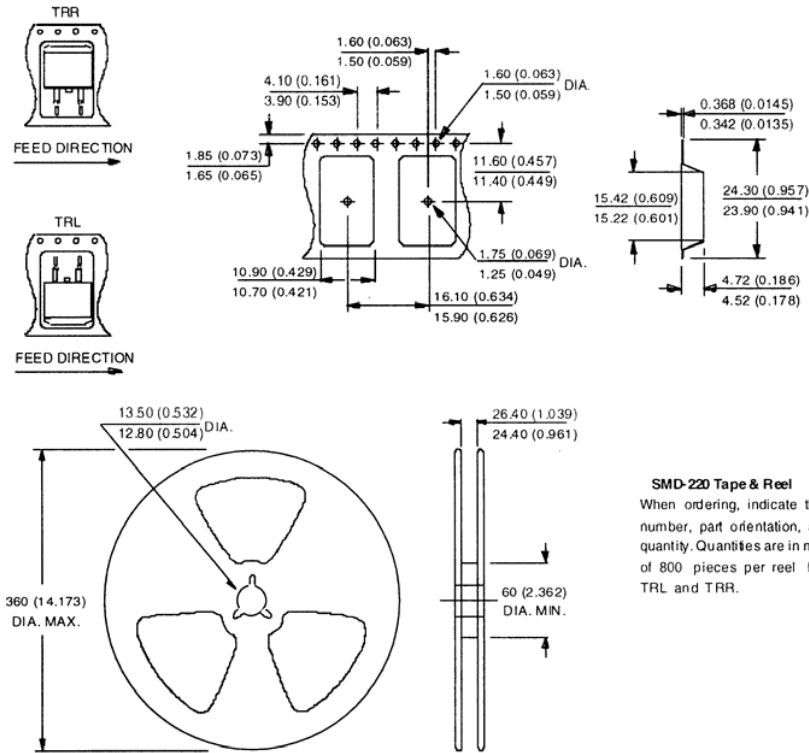

SMD-220 Tape & Reel

When ordering, indicate the part number, part orientation, and the quantity. Quantities are in multiples of 800 pieces per reel for both TRL and TRR.

Data and specifications subject to change without notice.
 This product has been designed and qualified for the Consumer market.
 Qualifications Standards can be found on IR's Web site.