

HiPerRF™ Power MOSFETs

F-Class: MegaHertz Switching

IXFX 24N100F
IXFK 24N100F

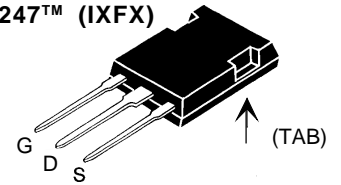
$V_{DSS} = 1000\text{ V}$
 $I_{D25} = 24\text{ A}$
 $R_{DS(on)} = 0.39\ \Omega$
 $t_{rr} \leq 250\text{ ns}$

N-Channel Enhancement Mode
Avalanche Rated, Low Q_g , Low Intrinsic R_g
High dV/dt , Low t_{rr}

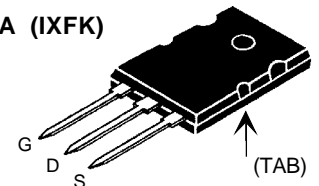


Symbol	Test Conditions	Maximum Ratings	
V_{DSS}	$T_J = 25^\circ\text{C to } 150^\circ\text{C}$	1000	V
V_{DGR}	$T_J = 25^\circ\text{C to } 150^\circ\text{C}; R_{GS} = 1\text{ M}\Omega$	1000	V
V_{GS}	Continuous	± 20	V
V_{GSM}	Transient	± 30	V
I_{D25}	$T_C = 25^\circ\text{C}$	24	A
I_{DM}	$T_C = 25^\circ\text{C}$, pulse width limited by T_{JM}	96	A
I_{AR}	$T_C = 25^\circ\text{C}$	24	A
E_{AR}	$T_C = 25^\circ\text{C}$	60	mJ
E_{AS}	$T_C = 25^\circ\text{C}$	3.0	J
dv/dt	$I_S \leq I_{DM}$, $di/dt \leq 100\text{ A}/\mu\text{s}$, $V_{DD} \leq V_{DSS}$ $T_J \leq 150^\circ\text{C}$, $R_G = 2\ \Omega$	10	V/ns
P_D	$T_C = 25^\circ\text{C}$	560	W
T_J		-55 ... +150	$^\circ\text{C}$
T_{JM}		150	$^\circ\text{C}$
T_{stg}		-55 ... +150	$^\circ\text{C}$
T_L	1.6 mm (0.063 in.) from case for 10 s	300	$^\circ\text{C}$
M_d	Mounting torque	TO-264	0.4/6 Nm/lb.in.
Weight		PLUS 247	6 g
		TO-264	10 g

PLUS 247™ (IXFX)



TO-264 AA (IXFK)



G = Gate
S = Source

D = Drain
TAB = Drain

Features

- RF capable MOSFETs
- Double metal process for low gate resistance
- Unclamped Inductive Switching (UIS) rated
- Low package inductance - easy to drive and to protect
- Fast intrinsic rectifier

Applications

- DC-DC converters
- Switched-mode and resonant-mode power supplies, >500kHz switching
- DC choppers
- Pulse generation
- Laser drivers

Advantages

- PLUS 247™ package for clip or spring mounting
- Space savings
- High power density

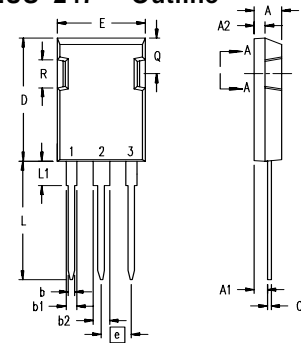
Symbol	Test Conditions	Characteristic Values ($T_J = 25^\circ\text{C}$, unless otherwise specified)		
		min.	typ.	max.
V_{DSS}	$V_{GS} = 0\text{ V}$, $I_D = 1\text{ mA}$	1000		V
$V_{GS(th)}$	$V_{DS} = V_{GS}$, $I_D = 8\text{ mA}$	3.0		5.5 V
I_{GSS}	$V_{GS} = \pm 20\text{ V}$, $V_{DS} = 0$			$\pm 200\text{ nA}$
I_{DSS}	$V_{DS} = V_{DSS}$, $V_{GS} = 0\text{ V}$		$T_J = 25^\circ\text{C}$ $T_J = 125^\circ\text{C}$	100 mA 3 mA
$R_{DS(on)}$	$V_{GS} = 10\text{ V}$, $I_D = 0.5 \cdot I_{D25}$ Note 1			0.39 Ω

Symbol	Test Conditions	Characteristic Values ($T_J = 25^\circ\text{C}$, unless otherwise specified)		
		min.	typ.	max.
g_{fs}	$V_{DS} = 10\text{ V}; I_D = 0.5 \cdot I_{D25}$ Note 1	16	24	S
C_{iss}	$V_{GS} = 0\text{ V}, V_{DS} = 25\text{ V}, f = 1\text{ MHz}$		6600	pF
C_{oss}			760	pF
C_{rss}			230	pF
$t_{d(on)}$	$V_{GS} = 10\text{ V}, V_{DS} = 0.5 \cdot V_{DSS}, I_D = 0.5 \cdot I_{D25}$ $R_G = 1\ \Omega$ (External)		22	ns
t_r			18	ns
$t_{d(off)}$			52	ns
t_f			11	ns
$Q_{g(on)}$	$V_{GS} = 10\text{ V}, V_{DS} = 0.5 \cdot V_{DSS}, I_D = 0.5 \cdot I_{D25}$		195	nC
Q_{gs}			40	nC
Q_{gd}			100	nC
R_{thJC}			0.21	K/W
R_{thCK}		0.15		K/W

Source-Drain Diode		Characteristic Values ($T_J = 25^\circ\text{C}$, unless otherwise specified)		
Symbol	Test Conditions	min.	typ.	max.
I_S	$V_{GS} = 0\text{ V}$			24 A
I_{SM}	Repetitive; pulse width limited by T_{JM}			96 A
V_{SD}	$I_F = I_S, V_{GS} = 0\text{ V}$, Note 1			1.5 V
t_{rr}	$I_F = I_S, -di/dt = 100\text{ A}/\mu\text{s}, V_R = 100\text{ V}$			250 ns
Q_{RM}			1.4	μC
I_{RM}			10	A

Note: 1. Pulse test, $t \leq 300\ \mu\text{s}$, duty cycle $d \leq 2\%$

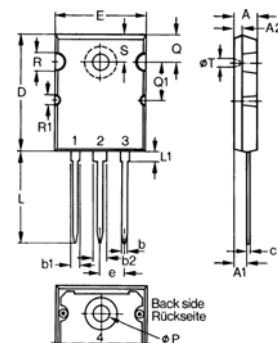
PLUS 247™ Outline



Terminals: 1 - Gate
2 - Drain (Collector)
3 - Source (Emitter)
4 - Drain (Collector)

Dim.	Millimeter		Inches	
	Min.	Max.	Min.	Max.
A	4.83	5.21	.190	.205
A ₁	2.29	2.54	.090	.100
A ₂	1.91	2.16	.075	.085
b	1.14	1.40	.045	.055
b ₁	1.91	2.13	.075	.084
b ₂	2.92	3.12	.115	.123
C	0.61	0.80	.024	.031
D	20.80	21.34	.819	.840
E	15.75	16.13	.620	.635
e	5.45 BSC		.215 BSC	
L	19.81	20.32	.780	.800
L1	3.81	4.32	.150	.170
Q	5.59	6.20	.220	0.244
R	4.32	4.83	.170	.190

TO-264 AA Outline



Dim.	Millimeter		Inches	
	Min.	Max.	Min.	Max.
A	4.82	5.13	.190	.202
A1	2.54	2.89	.100	.114
A2	2.00	2.10	.079	.083
b	1.12	1.42	.044	.056
b1	2.39	2.69	.094	.106
b2	2.90	3.09	.114	.122
c	0.53	0.83	.021	.033
D	25.91	26.16	1.020	1.030
E	19.81	19.96	.780	.786
e	5.46BSC		.215BSC	
J	0.00	0.25	.000	.010
K	0.00	0.25	.000	.010
L	20.32	20.83	.800	.820
L1	2.29	2.59	.090	.102
P	3.17	3.66	.125	.144
Q	6.07	6.27	.239	.247
Q1	8.38	8.69	.330	.342
R	3.81	4.32	.150	.170
R1	1.78	2.29	.070	.090
S	6.04	6.30	.238	.248
T	1.57	1.83	.062	.072

IXYS reserves the right to change limits, test conditions, and dimensions.

IXYS MOSFETs and IGBTs are covered by one or more of the following U.S. patents:

4,835,592	4,881,106	5,017,508	5,049,961	5,187,117	5,486,715	6,306,728B1
4,850,072	4,931,844	5,034,796	5,063,307	5,237,481	5,381,025	

Fig. 1. Output Characteristics at 25°C

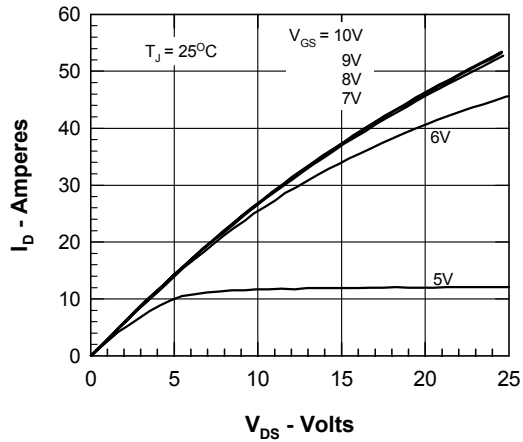


Fig. 2. Output Characteristics at 125°C

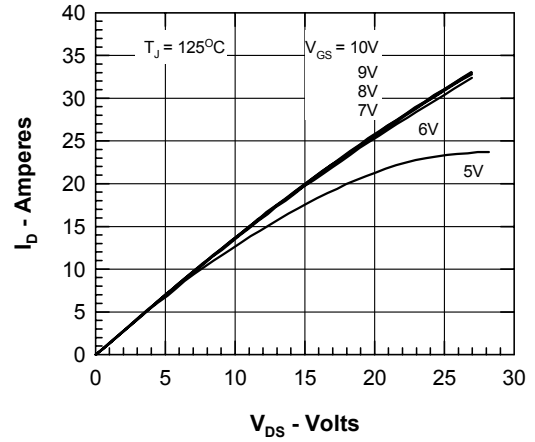
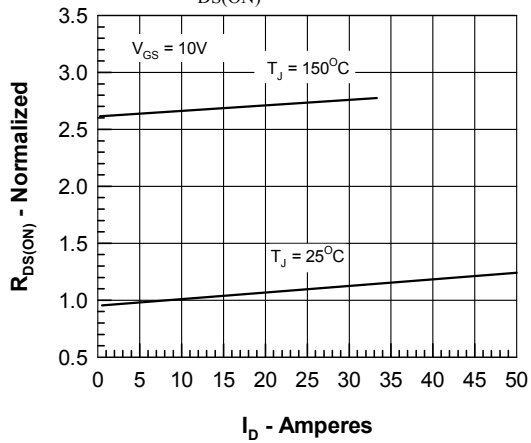
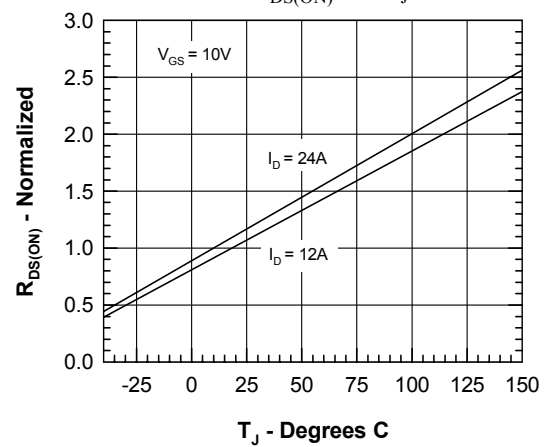
Fig. 3. $R_{DS(ON)}$ vs. Drain CurrentFig. 4. $R_{DS(ON)}$ vs. T_J 

Fig. 5. Drain vs. Case Temperature

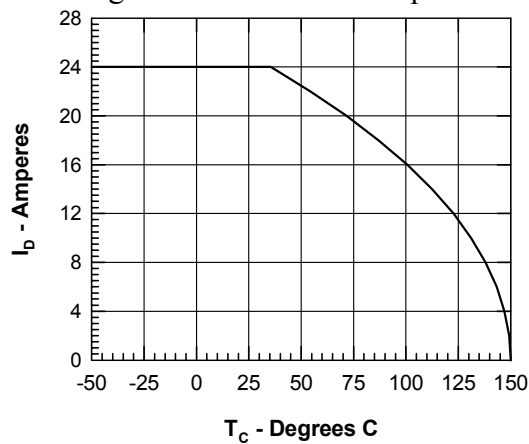


Fig. 6. Admittance Curves

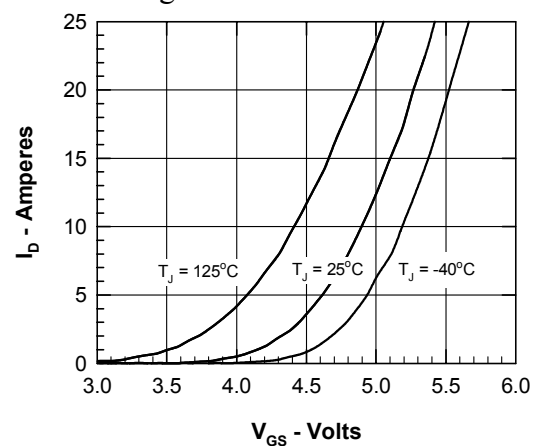


Fig. 7. Gate Charge Characteristic Curve

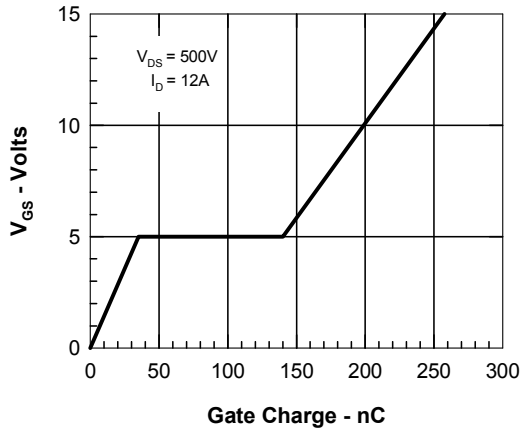


Fig. 8. Capacitance Curves

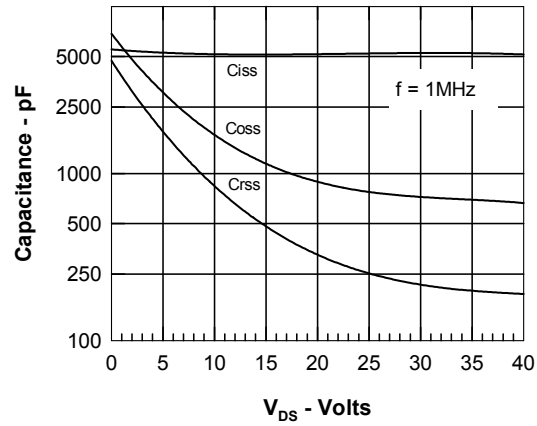


Fig. 9. Source Current vs. Source to Drain Voltage

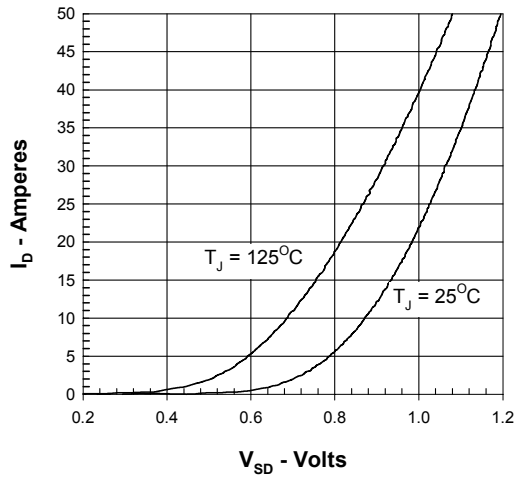


Fig. 10. Thermal Impedence

