

# AT-31011, AT-31033

## Low Current, High Performance NPN Silicon Bipolar Transistor



### Data Sheet



Lead (Pb) Free  
RoHS 6 fully  
compliant



#### Description

Avago's AT-31011 and AT-31033 are high performance NPN bipolar transistors that have been optimized for operation at low voltages, making them ideal for use in battery powered applications in wireless markets. The AT-31033 uses the 3 lead SOT-23, while the AT-31011 places the same die in the higher performance 4 lead SOT-143. Both packages are industry standards compatible with high volume surface mount assembly techniques.

The 3.2 micron emitter-to-emitter pitch and reduced parasitic design of these transistors yields extremely high performance products that can perform a multiplicity of tasks. The 10 emitter finger interdigitated geometry yields an extremely fast transistor with low operating currents and reasonable impedances.

Optimized performance at 2.7 V makes these devices ideal for use in 900 MHz, 1.9 GHz, and 2.4 GHz battery operated systems as an LNA, gain stage, buffer, oscillator, or active mixer. Applications include cellular and PCS handsets as well as Industrial-Scientific-Medical systems. Typical amplifier designs at 900 MHz yield 1.3 dB noise figures with 11 dB or more associated gain at a 2.7 V, 1 mA bias. Moderate output power capability (+9 dBm  $P_{1dB}$ ) coupled with an excellent noise figure yields high dynamic range for a microcurrent device. High gain capability at 1 V/1 mA makes these devices a good fit for 900 MHz pager applications.

The AT-3 series bipolar transistors are fabricated using an optimized version of Avago's 10 GHz  $f_T$ , 30 GHz  $f_{max}$  Self-Aligned-Transistor (SAT) process. The die are nitride passivated for surface protection. Excellent device uniformity, performance and reliability are produced by the use of ion-implantation, self-alignment techniques, and gold metalization in the fabrication of these devices.

#### Features

- High Performance Bipolar Transistor Optimized for Low Current, Low Voltage Operation
- 900 MHz Performance:  
AT-31011: 0.9 dB NF, 13 dB  $G_A$   
AT-31033: 0.9 dB NF, 11 dB  $G_A$
- Characterized for End-Of-Life Battery Use (2.7 V)
- SOT-143 SMT Plastic Package
- Tape-And-Reel Packaging Option Available
- Lead-free

#### Pin Connections and Package Marking

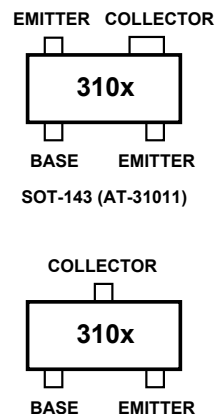

#### Notes:

**Top View. Package Marking provides orientation and identification. "x" is the date code.**

## AT-31011, AT-31033 Absolute Maximum Ratings

Symbol	Parameter	Units	Absolute Maximum <sup>[1]</sup>
$V_{EBO}$	Emitter-Base Voltage	V	1.5
$V_{CBO}$	Collector-Base Voltage	V	11
$V_{CEO}$	Collector-Emitter Voltage	V	5.5
$I_C$	Collector Current	mA	16
$P_T$	Power Dissipation <sup>[2,3]</sup>	mW	150
$T_j$	Junction Temperature	°C	150
$T_{STG}$	Storage Temperature	°C	-65 to 150

Thermal Resistance<sup>[2]</sup>:

$$\theta_{jc} = 550^\circ\text{C/W}$$

Notes:

1. Operation of this device above any one of these parameters may cause permanent damage.
2.  $T_{\text{Mounting Surface}} = 25^\circ\text{C}$ .
3. Derate at 1.82 mW/°C for  $T_C > 67.5^\circ\text{C}$ .

## Electrical Specifications, $T_A = 25^\circ\text{C}$

Symbol	Parameters and Test Conditions	Units	AT-31011			AT-31033		
			Min	Typ	Max	Min	Typ	Max
NF	Noise Figure $V_{CE} = 2.7\text{ V}, I_C = 1\text{ mA}$	$f = 0.9\text{ GHz}$ dB		0.9 <sup>[1]</sup>	1.2 <sup>[1]</sup>		0.9 <sup>[2]</sup>	1.2 <sup>[2]</sup>
$G_A$	Associated Gain $V_{CE} = 2.7\text{ V}, I_C = 1\text{ mA}$	$f = 0.9\text{ GHz}$ dB	11 <sup>[1]</sup>	13 <sup>[1]</sup>		9 <sup>[2]</sup>	11 <sup>[2]</sup>	
$h_{FE}$	Forward Current Transfer Ratio	$V_{CE} = 2.7\text{ V}$ $I_C = 1\text{ mA}$	-	70	300	70	300	
$I_{CBO}$	Collector Cutoff Current	$V_{CB} = 3\text{ V}$	$\mu\text{A}$	0.05	0.2	0.05	0.2	
$I_{EBO}$	Emitter Cutoff Current	$V_{EB} = 1\text{ V}$	$\mu\text{A}$	0.1	1.5	0.1	1.5	

Notes:

1. Test circuit B, Figure 1. Numbers reflect device performance de-embedded from circuit losses. Input loss = 0.4 dB; output loss = 0.4 dB.
2. Test circuit A, Figure 1. Numbers reflect device performance de-embedded from circuit losses. Input loss = 0.4 dB; output loss = 0.4 dB.

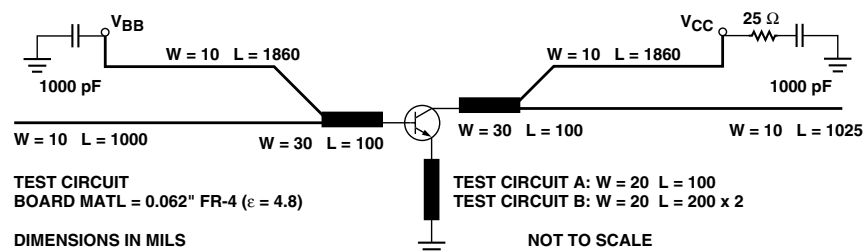

Figure 1. Test Circuit for Noise Figure and Associated Gain. This Circuit is a Compromise Match Between Best Noise Figure, Best Gain, Stability, a Practical, Synthesizable Match, and a Circuit Capable of Matching Both the AT-305 and AT-310 Geometries.

## Characterization Information, $T_A = 25^\circ\text{C}$

Symbol	Parameters and Test Conditions	Units	AT-31011	AT-31033
			Typ	Typ
$P_{1\text{dB}}$	Power at 1 dB Gain Compression (opt tuning) $V_{CE} = 2.7\text{ V}, I_C = 10\text{ mA}$	$f = 0.9\text{ GHz}$ dBm	9	9
$G_{1\text{dB}}$	Gain at 1 dB Gain Compression (opt tuning) $V_{CE} = 2.7\text{ V}, I_C = 10\text{ mA}$	$f = 0.9\text{ GHz}$ dB	15	13
$IP_3$	Output Third Order Intercept Point, $V_{CE} = 2.7\text{ V}, I_C = 10\text{ mA}$ (opt tuning)	$f = 0.9\text{ GHz}$ dBm	20	20
$ S_{21} ^2$	Gain in $50\ \Omega$ System; $V_{CE} = 2.7\text{ V}, I_C = 1\text{ mA}$	$f = 0.9\text{ GHz}$ dB	10	9
$C_{CB}$	Collector-Base Capacitance	$V_{CB} = 3\text{ V}, f = 1\text{ MHz}$ pF	0.04	0.04

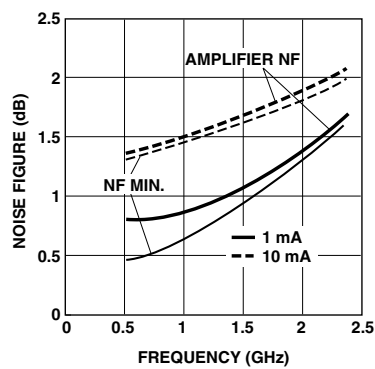

Figure 2. AT-31011 and AT-31033 Minimum Noise Figure and Amplifier NF<sup>1)</sup> vs. Frequency and Current at  $V_{CE} = 2.7\text{ V}$ .

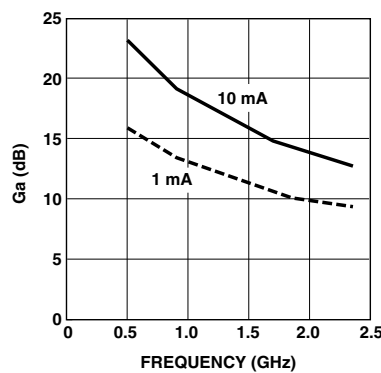

Figure 3. AT-31011 Associated Gain at Optimum Noise Match vs. Frequency and Current at  $V_{CE} = 2.7\text{ V}$ .

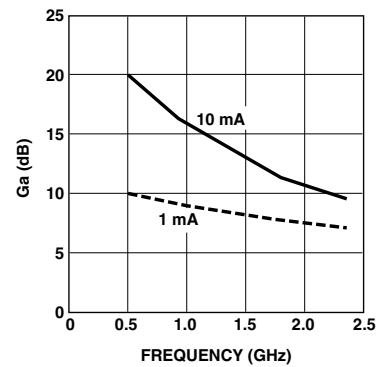

Figure 4. AT-31033 Associated Gain at Optimum Noise Match vs. Frequency and Current at  $V_{CE} = 2.7\text{ V}$ .

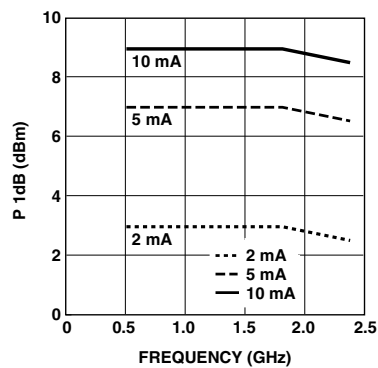

Figure 5. AT-31011 and AT-31033 Power at 1 dB Gain Compression vs. Frequency and Current at  $V_{CE} = 2.7\text{ V}$ .

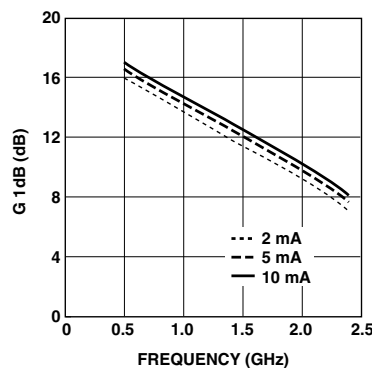

Figure 6. AT-31011 1 dB Compressed Gain vs. Frequency and Current at  $V_{CE} = 2.7\text{ V}$ .

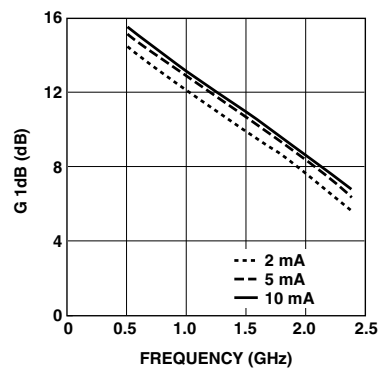

Figure 7. AT-31033 1 dB Compressed Gain vs. Frequency and Current at  $V_{CE} = 2.7\text{ V}$ .

### Note:

1. Amplifier NF represents the noise figure which can be expected in a real circuit representing reasonable reflection coefficients and including circuit losses.

## AT-31011, AT-31033 Typical Performance

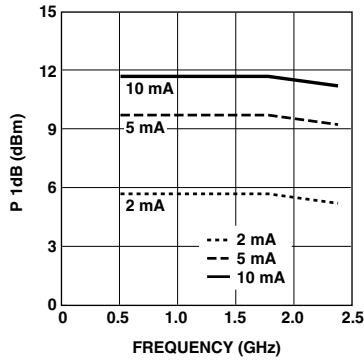

Figure 8. AT-31011 and AT-31033 Power at 1 dB Gain Compression vs. Frequency and Current at  $V_{CE} = 5$  V.

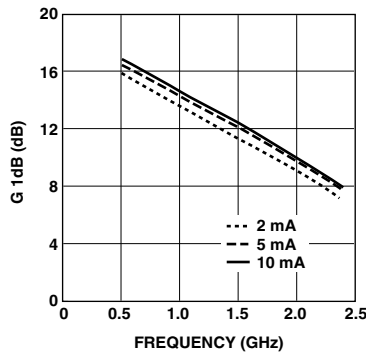

Figure 9. AT-31011 1 dB Compressed Gain vs. Frequency and Current at  $V_{CE} = 5$  V.

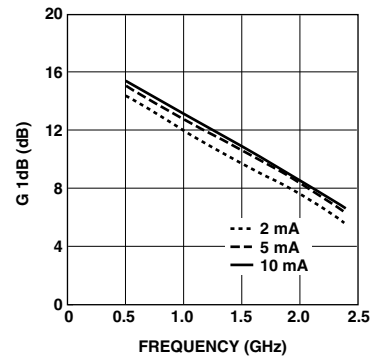

Figure 10. AT-31033 1 dB Compressed Gain vs. Frequency and Current at  $V_{CE} = 5$  V.

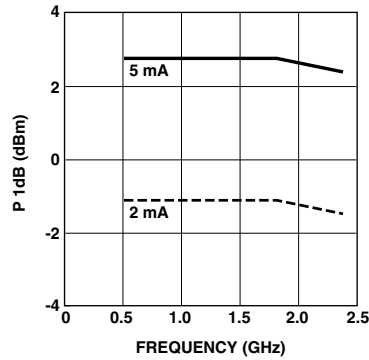

Figure 11. AT-31011 and AT-31033 Power at 1 dB Gain Compression vs. Frequency and Current at  $V_{CE} = 1$  V.

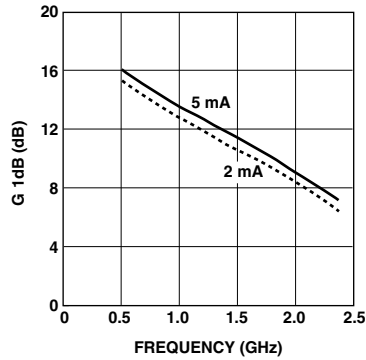

Figure 12. AT-31011 1 dB Compressed Gain vs. Frequency and Current at  $V_{CE} = 1$  V.

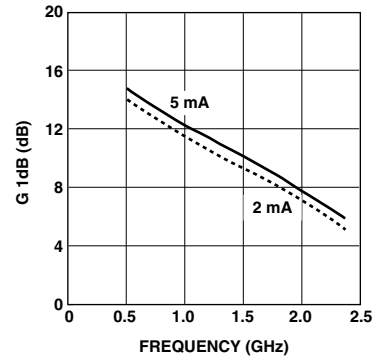

Figure 13. AT-31033 1 dB Compressed Gain vs. Frequency and Current at  $V_{CE} = 1$  V.

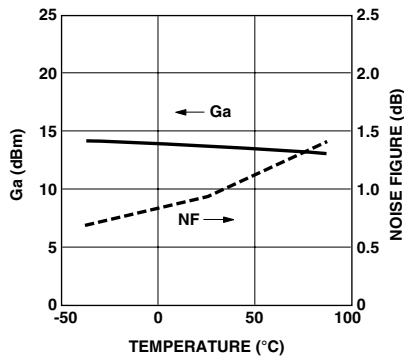

Figure 14. AT-31011 Noise Figure and Associated Gain at  $V_{CE} = 2.7$  V,  $I_C = 1$  mA vs. Temperature in Test Circuit, Figure 1. (Circuit Losses De-embedded)

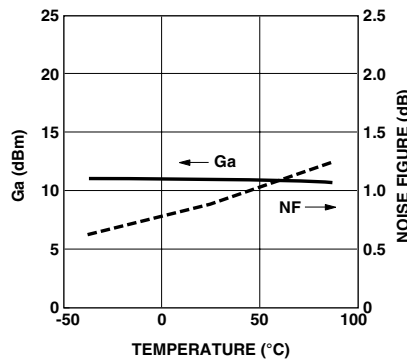

Figure 15. AT-31033 Noise Figure and Associated Gain at  $V_{CE} = 2.7$  V,  $I_C = 1$  mA vs. Temperature in Test Circuit, Figure 1. (Circuit Losses De-embedded)

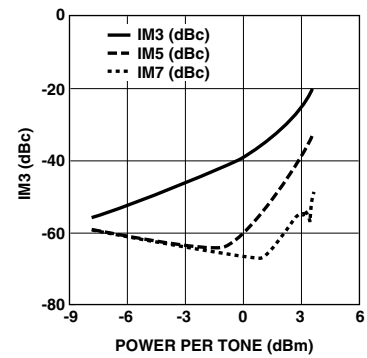

Figure 16. AT-31011 and AT-31033 Intermodulation Products vs. Output Power at  $V_{CE} = 2.7$  V,  $I_C = 10$  mA, 900 MHz with Optimal Tuning.

**AT-31011 Typical Scattering Parameters,  $V_{CE} = 1\text{ V}$ ,  $I_C = 1\text{ mA}$ , Common Emitter,  $Z_O = 50\ \Omega$**

Freq. GHz	$S_{11}$			$S_{21}$			$S_{12}$		$S_{22}$	
	Mag	Ang	dB	Mag	Ang	dB	Mag	Ang	Mag	Ang
0.1	0.95	-8	11.12	3.60	174	-37.91	0.01	85	0.999	-3
0.5	0.92	-34	10.58	3.38	150	-24.67	0.06	68	0.94	-15
0.9	0.81	-60	9.74	3.07	130	-20.67	0.09	53	0.89	-25
1.0	0.79	-66	9.33	2.93	125	-20.03	0.10	50	0.88	-27
1.5	0.66	-94	8.02	2.52	104	-18.34	0.12	36	0.80	-36
1.8	0.60	-110	7.18	2.28	93	-17.95	0.13	30	0.76	-40
2.0	0.57	-119	6.76	2.18	87	-17.73	0.13	27	0.74	-42
2.4	0.51	-139	5.56	1.90	74	-17.69	0.13	22	0.71	-46
3.0	0.45	-167	4.22	1.63	57	-17.95	0.13	19	0.67	-51
4.0	0.45	153	2.30	1.30	36	-18.33	0.12	22	0.64	-62
5.0	0.49	120	0.73	1.09	17	-17.33	0.14	32	0.62	-72

**AT-31011 Typical Noise Parameters,**

Common Emitter,  $Z_O = 50\ \Omega$ ,  $1\text{ V}$ ,  $I_C = 1\text{ mA}$

Freq GHz	$F_{min}^{[1]}$ dB	$\Gamma_{OPT}$		$R_n$
		Mag	Ang	
0.5 <sup>[2]</sup>	0.5	0.90	13	0.85
0.9	0.6	0.85	29	0.73
1.8	1.1	0.68	67	0.46
2.4	1.6	0.55	98	0.28

**Notes:**

1. Matching constraints may make  $F_{min}$  values associated with high  $|\Gamma_{OPT}|$  values unachievable in physical circuits. See Figure 2 for expected performance.
2. 0.5 GHz noise parameter values are extrapolated, not measured.

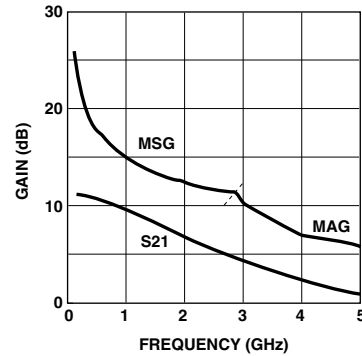

Figure 17. AT-31011 Gains vs. Frequency at  $V_{CE} = 1\text{ V}$ ,  $I_C = 1\text{ mA}$ .

**AT-31033 Typical Scattering Parameters,  $V_{CE} = 1\text{ V}$ ,  $I_C = 1\text{ mA}$ , Common Emitter,  $Z_O = 50\ \Omega$**

Freq. GHz	$S_{11}$			$S_{21}$			$S_{12}$		$S_{22}$	
	Mag	Ang	dB	Mag	Ang	dB	Mag	Ang	Mag	Ang
0.1	0.94	-7	11.16	3.61	173	-35.95	0.02	85	0.999	-3
0.5	0.87	-34	10.37	3.30	144	-22.84	0.07	68	0.92	-17
0.9	0.70	-58	9.17	2.87	121	-19.06	0.11	56	0.85	-27
1.0	0.66	-64	8.69	2.72	115	-18.49	0.12	53	0.83	-29
1.5	0.46	-90	7.11	2.27	92	-16.94	0.14	45	0.74	-37
1.8	0.36	-106	6.16	2.03	81	-16.40	0.15	43	0.70	-40
2.0	0.31	-117	5.66	1.92	74	-16.06	0.16	42	0.68	-42
2.4	0.22	-143	4.48	1.67	62	-15.50	0.17	42	0.66	-45
3.0	0.16	166	3.19	1.44	46	-14.34	0.19	44	0.63	-50
4.0	0.23	101	1.39	1.17	25	-11.85	0.26	46	0.60	-62
5.0	0.33	67	0.05	1.01	9	-9.11	0.35	41	0.56	-77

**AT-31033 Typical Noise Parameters,**

Common Emitter,  $Z_O = 50\ \Omega$ ,  $1\text{ V}$ ,  $I_C = 1\text{ mA}$

Freq GHz	$F_{min}^{[1]}$ dB	$\Gamma_{OPT}$		$R_n$
		Mag	Ang	
0.5 <sup>[2]</sup>	0.5	0.90	12	0.70
0.9	0.6	0.82	28	0.60
1.8	1.1	0.57	68	0.38
2.4	1.6	0.41	100	0.22

**Notes:**

1. Matching constraints may make  $F_{min}$  values associated with high  $|\Gamma_{OPT}|$  values unachievable in physical circuits. See Figure 2 for expected performance.
2. 0.5 GHz noise parameter values are extrapolated, not measured.

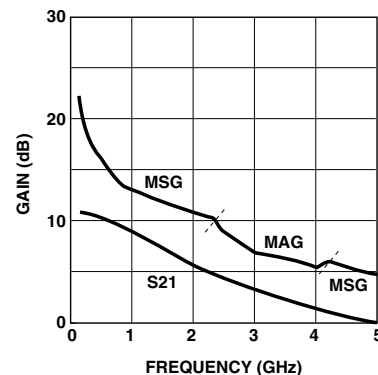

Figure 18. AT-31033 Gains vs. Frequency at  $V_{CE} = 1\text{ V}$ ,  $I_C = 1\text{ mA}$ .

**AT-31011 Typical Scattering Parameters,  $V_{CE} = 2.7\text{ V}$ ,  $I_C = 1\text{ mA}$ , Common Emitter,  $Z_O = 50\ \Omega$**

Freq. GHz	$S_{11}$			$S_{21}$			$S_{12}$		$S_{22}$	
	Mag	Ang	dB	Mag	Ang	dB	Mag	Ang	Mag	Ang
0.1	0.96	-7	11.11	3.59	174	-39.92	0.01	86	0.999	-2
0.5	0.93	-32	10.66	3.41	152	-26.43	0.05	69	0.95	-13
0.9	0.83	-56	9.90	3.13	132	-22.32	0.08	55	0.91	-22
1.0	0.81	-61	9.53	2.99	128	-21.66	0.08	53	0.90	-24
1.5	0.68	-89	8.32	2.61	107	-19.90	0.10	40	0.84	-32
1.8	0.62	-104	7.52	2.38	96	-19.46	0.11	34	0.80	-36
2.0	0.58	-113	7.15	2.28	90	-19.24	0.11	31	0.78	-38
2.4	0.52	-133	5.98	1.99	77	-19.15	0.11	27	0.75	-42
3.0	0.45	-160	4.65	1.71	61	-19.37	0.11	25	0.72	-46
4.0	0.43	158	2.75	1.37	39	-19.60	0.10	29	0.69	-56
5.0	0.46	123	1.16	1.14	20	-18.16	0.12	41	0.68	-66

**AT-31011 Typical Noise Parameters,**

Common Emitter,  $Z_O = 50\ \Omega$ ,  $2.7\text{ V}$ ,  $I_C = 1\text{ mA}$

Freq GHz	$F_{min}^{[1]}$ dB	$\Gamma_{OPT}$		$R_n$
		Mag	Ang	
0.5 <sup>[2]</sup>	0.5	0.92	13	0.85
0.9	0.6	0.85	29	0.73
1.8	1.1	0.68	67	0.46
2.4	1.6	0.55	98	0.28

**Notes:**

1. Matching constraints may make  $F_{min}$  values associated with high  $|\Gamma_{OPT}|$  values unachievable in physical circuits. See Figure 2 for expected performance.
2. 0.5 GHz noise parameter values are extrapolated, not measured.

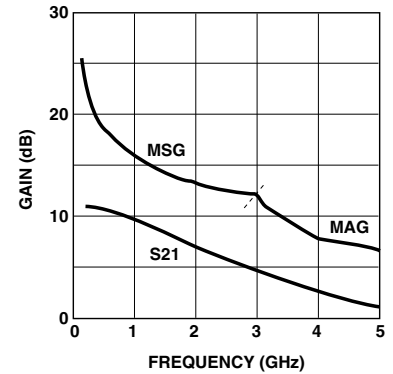

Figure 19. AT-31011 Gains vs. Frequency at  $V_{CE} = 2.7\text{ V}$ ,  $I_C = 1\text{ mA}$ .

**AT-31033 Typical Scattering Parameters,  $V_{CE} = 2.7\text{ V}$ ,  $I_C = 1\text{ mA}$ , Common Emitter,  $Z_O = 50\ \Omega$**

Freq. GHz	$S_{11}$			$S_{21}$			$S_{12}$		$S_{22}$	
	Mag	Ang	dB	Mag	Ang	dB	Mag	Ang	Mag	Ang
0.1	0.94	-7	11.07	3.58	173	-37.44	0.01	86	0.999	-3
0.5	0.89	-32	10.35	3.29	146	-24.11	0.06	70	0.94	-15
0.9	0.72	-54	9.27	2.91	123	-20.27	0.10	58	0.87	-25
1.0	0.69	-59	8.80	2.76	118	-19.65	0.10	56	0.86	-26
1.5	0.48	-83	7.32	2.32	95	-18.01	0.13	48	0.78	-33
1.8	0.38	-97	6.39	2.09	84	-17.43	0.13	46	0.74	-36
2.0	0.33	-107	5.91	1.97	77	-17.07	0.14	45	0.72	-38
2.4	0.23	-130	4.73	1.72	65	-16.46	0.15	46	0.70	-41
3.0	0.14	-178	3.43	1.48	49	-15.25	0.17	48	0.67	-46
4.0	0.19	103	1.62	1.21	28	-12.62	0.23	51	0.65	-57
5.0	0.30	67	0.25	1.03	12	-9.72	0.33	47	0.63	-71

**AT-31033 Typical Noise Parameters,**

Common Emitter,  $Z_O = 50\ \Omega$ ,  $2.7\text{ V}$ ,  $I_C = 1\text{ mA}$

Freq GHz	$F_{min}^{[1]}$ dB	$\Gamma_{OPT}$		$R_n$
		Mag	Ang	
0.5 <sup>[2]</sup>	0.5	0.90	12	0.70
0.9	0.6	0.82	28	0.60
1.8	1.1	0.57	68	0.38
2.4	1.6	0.41	100	0.22

**Notes:**

1. Matching constraints may make  $F_{min}$  values associated with high  $|\Gamma_{OPT}|$  values unachievable in physical circuits. See Figure 2 for expected performance.
2. 0.5 GHz noise parameter values are extrapolated, not measured.

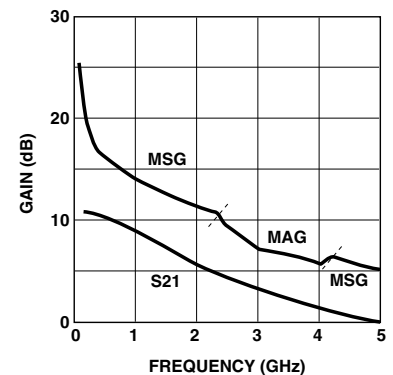

Figure 20. AT-31033 Gains vs. Frequency at  $V_{CE} = 2.7\text{ V}$ ,  $I_C = 1\text{ mA}$ .

**AT-31011 Typical Scattering Parameters,  $V_{CE} = 2.7\text{ V}$ ,  $I_C = 10\text{ mA}$ , Common Emitter,  $Z_O = 50\ \Omega$**

Freq. GHz	$S_{11}$			$S_{21}$			$S_{12}$		$S_{22}$	
	Mag	Ang	dB	Mag	Ang	dB	Mag	Ang	Mag	Ang
0.1	0.74	-23	27.42	23.49	161	-41.00	0.01	77	0.95	-9
0.5	0.46	-85	22.65	13.57	116	-30.64	0.03	59	0.68	-24
0.9	0.32	-121	18.73	8.64	97	-27.55	0.04	59	0.59	-27
1.0	0.30	-128	17.91	7.86	93	-27.05	0.04	59	0.58	-27
1.5	0.25	-161	14.77	5.48	79	-24.48	0.06	61	0.55	-30
1.8	0.25	-177	13.29	4.62	72	-23.26	0.07	61	0.54	-32
2.0	0.24	174	12.42	4.18	68	-22.51	0.07	61	0.53	-33
2.4	0.25	157	10.97	3.54	60	-21.12	0.09	59	0.53	-36
3.0	0.27	138	9.11	2.86	49	-19.31	0.11	58	0.52	-40
4.0	0.31	113	6.86	2.20	33	-16.88	0.14	54	0.51	-50
5.0	0.37	94	5.19	1.82	17	-14.75	0.18	48	0.50	-59

**AT-31011 Typical Noise Parameters,**

Common Emitter,  $Z_O = 50\ \Omega$ ,  $2.7\text{ V}$ ,  $I_C = 10\text{ mA}$

Freq GHz	$F_{min}^{[1]}$ dB	$\Gamma_{OPT}$		$R_n$
		Mag	Ang	
0.5 <sup>[2]</sup>	1.3	0.45	11	0.55
0.9	1.4	0.37	33	0.46
1.8	1.7	0.25	86	0.29
2.4	2.0	0.18	129	0.18

**Notes:**

1. Matching constraints may make  $F_{min}$  values associated with high  $|\Gamma_{OPT}|$  values unachievable in physical circuits. See Figure 2 for expected performance.
2. 0.5 GHz noise parameter values are extrapolated, not measured.

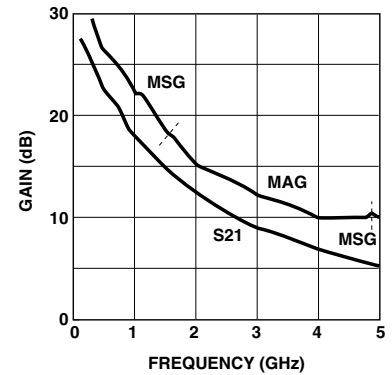

Figure 21. AT-31011 Gains vs. Frequency at  $V_{CE} = 2.7\text{ V}$ ,  $I_C = 10\text{ mA}$ .

**AT-31033 Typical Scattering Parameters,  $V_{CE} = 2.7\text{ V}$ ,  $I_C = 10\text{ mA}$ , Common Emitter,  $Z_O = 50\ \Omega$**

Freq. GHz	$S_{11}$			$S_{21}$			$S_{12}$		$S_{22}$	
	Mag	Ang	dB	Mag	Ang	dB	Mag	Ang	Mag	Ang
0.1	0.72	-21	26.80	21.87	154	-38.46	0.01	80	0.92	-10
0.5	0.33	-49	19.93	9.92	106	-27.31	0.04	73	0.66	-20
0.9	0.19	-47	15.51	5.96	88	-22.90	0.07	72	0.61	-22
1.0	0.17	-46	14.66	5.41	85	-22.03	0.08	72	0.60	-23
1.5	0.11	-28	11.44	3.73	72	-18.74	0.12	69	0.59	-27
1.8	0.10	-14	9.99	3.16	66	-17.26	0.14	67	0.58	-30
2.0	0.10	-6	9.15	2.87	62	-16.40	0.15	65	0.58	-32
2.4	0.10	9	7.78	2.45	54	-14.88	0.18	62	0.57	-35
3.0	0.12	23	6.16	2.03	43	-12.99	0.22	57	0.55	-41
4.0	0.15	34	4.30	1.64	27	-10.49	0.30	48	0.52	-53
5.0	0.20	36	3.01	1.41	12	-8.53	0.37	38	0.48	-65

**AT-31033 Typical Noise Parameters,**

Common Emitter,  $Z_O = 50\ \Omega$ ,  $2.7\text{ V}$ ,  $I_C = 10\text{ mA}$

Freq GHz	$F_{min}^{[1]}$ dB	$\Gamma_{OPT}$		$R_n$
		Mag	Ang	
0.5 <sup>[2]</sup>	1.3	0.42	10	0.38
0.9	1.4	0.31	30	0.34
1.8	1.7	0.16	80	0.23
2.4	2.0	0.08	118	0.17

**Notes:**

1. Matching constraints may make  $F_{min}$  values associated with high  $|\Gamma_{OPT}|$  values unachievable in physical circuits. See Figure 2 for expected performance.
2. 0.5 GHz noise parameter values are extrapolated, not measured.

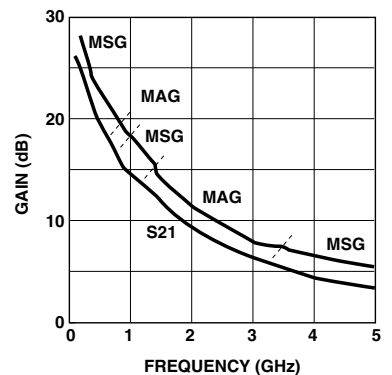

Figure 22. AT-31033 Gains vs. Frequency at  $V_{CE} = 2.7\text{ V}$ ,  $I_C = 10\text{ mA}$ .

### AT-31011 Typical Scattering Parameters, $V_{CE} = 5\text{ V}$ , $I_C = 1\text{ mA}$ , Common Emitter, $Z_O = 50\ \Omega$

Freq. GHz	$S_{11}$			$S_{21}$			$S_{12}$		$S_{22}$	
	Mag	Ang	dB	Mag	Ang	dB	Mag	Ang	Mag	Ang
0.1	0.96	-7	11.10	3.59	174	-40.35	0.01	84	0.999	-2
0.5	0.94	-31	10.67	3.41	153	-26.95	0.04	69	0.96	-13
0.9	0.83	-54	9.93	3.14	133	-22.80	0.07	56	0.92	-22
1.0	0.81	-60	9.57	3.01	129	-22.18	0.08	53	0.91	-23
1.5	0.68	-86	8.41	2.63	108	-20.33	0.10	41	0.85	-31
1.8	0.62	-101	7.62	2.40	97	-19.85	0.10	35	0.81	-35
2.0	0.58	-110	7.27	2.31	91	-19.64	0.10	32	0.79	-37
2.4	0.52	-129	6.10	2.02	78	-19.50	0.11	28	0.76	-41
3.0	0.44	-157	4.78	1.73	62	-19.68	0.10	26	0.73	-45
4.0	0.42	161	2.90	1.40	40	-19.86	0.10	31	0.70	-55
5.0	0.45	125	1.33	1.17	21	-18.35	0.12	43	0.70	-65

### AT-31011 Typical Noise Parameters,

Common Emitter,  $Z_O = 50\ \Omega$ ,  $5\text{ V}$ ,  $I_C = 1\text{ mA}$

Freq GHz	$F_{min}^{[1]}$ dB	$\Gamma_{OPT}$		$R_n$
		Mag	Ang	
0.5 <sup>[2]</sup>	0.5	0.92	13	0.85
0.9	0.6	0.85	29	0.73
1.8	1.1	0.68	67	0.46
2.4	1.6	0.55	98	0.28

#### Notes:

- Matching constraints may make  $F_{min}$  values associated with high  $|\Gamma_{OPT}|$  values unachievable in physical circuits. See Figure 2 for expected performance.
- 0.5 GHz noise parameter values are extrapolated, not measured.

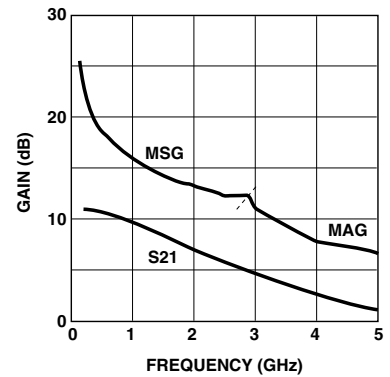

Figure 23. AT-31011 Gains vs. Frequency at  $V_{CE} = 5\text{ V}$ ,  $I_C = 1\text{ mA}$ .

### AT-31033 Typical Scattering Parameters, $V_{CE} = 5\text{ V}$ , $I_C = 1\text{ mA}$ , Common Emitter, $Z_O = 50\ \Omega$

Freq. GHz	$S_{11}$			$S_{21}$			$S_{12}$		$S_{22}$	
	Mag	Ang	dB	Mag	Ang	dB	Mag	Ang	Mag	Ang
0.1	0.95	-7	10.93	3.52	173	-37.78	0.01	85	0.999	-3
0.5	0.89	-31	10.24	3.25	147	-24.43	0.06	70	0.94	-15
0.9	0.73	-52	9.20	2.88	124	-20.49	0.09	59	0.88	-24
1.0	0.70	-57	8.75	2.74	119	-19.91	0.10	57	0.87	-26
1.5	0.49	-80	7.30	2.32	96	-18.15	0.12	49	0.79	-32
1.8	0.39	-93	6.41	2.09	85	-17.54	0.13	47	0.75	-36
2.0	0.34	-102	5.93	1.98	78	-17.19	0.14	46	0.73	-37
2.4	0.23	-122	4.77	1.73	66	-16.55	0.15	46	0.71	-40
3.0	0.13	-166	3.49	1.49	50	-15.35	0.17	49	0.68	-45
4.0	0.17	107	1.71	1.22	29	-12.83	0.23	51	0.66	-56
5.0	0.28	68	0.32	1.04	12	-9.96	0.32	48	0.64	-69

### AT-31033 Typical Noise Parameters,

Common Emitter,  $Z_O = 50\ \Omega$ ,  $5\text{ V}$ ,  $I_C = 1\text{ mA}$

Freq GHz	$F_{min}^{[1]}$ dB	$\Gamma_{OPT}$		$R_n$
		Mag	Ang	
0.5 <sup>[2]</sup>	0.5	0.90	12	0.70
0.9	0.6	0.82	28	0.60
1.8	1.1	0.57	68	0.38
2.4	1.6	0.41	100	0.22

#### Notes:

- Matching constraints may make  $F_{min}$  values associated with high  $|\Gamma_{OPT}|$  values unachievable in physical circuits. See Figure 2 for expected performance.
- 0.5 GHz noise parameter values are extrapolated, not measured.

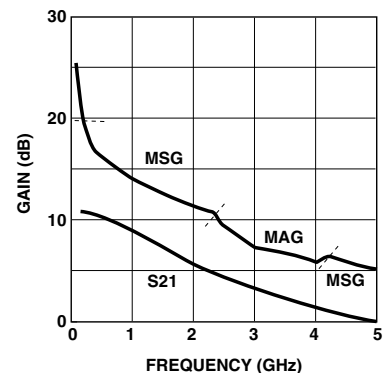

Figure 24. AT-31033 Gains vs. Frequency at  $V_{CE} = 5\text{ V}$ ,  $I_C = 1\text{ mA}$ .



**AT-31011 Typical Scattering Parameters,  $V_{CE} = 5\text{ V}$ ,  $I_C = 10\text{ mA}$ , Common Emitter,  $Z_O = 50\ \Omega$**

Freq. GHz	$S_{11}$			$S_{21}$			$S_{12}$		$S_{22}$	
	Mag	Ang	dB	Mag	Ang	dB	Mag	Ang	Mag	Ang
0.1	0.77	-21	27.41	23.46	162	-41.49	0.01	80	0.95	-8
0.5	0.48	-77	22.97	14.07	118	-30.66	0.03	61	0.70	-24
0.9	0.32	-112	19.14	9.06	98	-27.77	0.04	59	0.61	-27
1.0	0.30	-119	18.34	8.26	95	-27.11	0.04	60	0.59	-27
1.5	0.23	-151	15.23	5.78	80	-24.56	0.06	60	0.56	-29
1.8	0.22	-168	13.75	4.87	73	-23.37	0.07	60	0.55	-31
2.0	0.21	-178	12.91	4.42	69	-22.62	0.07	60	0.55	-32
2.4	0.21	163	11.46	3.74	61	-21.25	0.09	59	0.54	-36
3.0	0.23	142	9.60	3.02	50	-19.45	0.11	58	0.53	-39
4.0	0.27	116	7.36	2.33	34	-17.08	0.14	54	0.52	-48
5.0	0.33	96	5.70	1.93	19	-14.97	0.18	48	0.51	-58

**AT-31011 Typical Noise Parameters,**

Common Emitter,  $Z_O = 50\ \Omega$ ,  $5\text{ V}$ ,  $I_C = 10\text{ mA}$

Freq GHz	$F_{min}^{[1]}$ dB	$\Gamma_{OPT}$		$R_n$
		Mag	Ang	
0.5 <sup>[2]</sup>	1.3	0.45	11	0.55
0.9	1.4	0.37	33	0.46
1.8	1.7	0.25	86	0.29
2.4	2.0	0.18	129	0.18

**Notes:**

1. Matching constraints may make  $F_{min}$  values associated with high  $|\Gamma_{OPT}|$  values unachievable in physical circuits. See Figure 2 for expected performance.
2. 0.5 GHz noise parameter values are extrapolated, not measured.

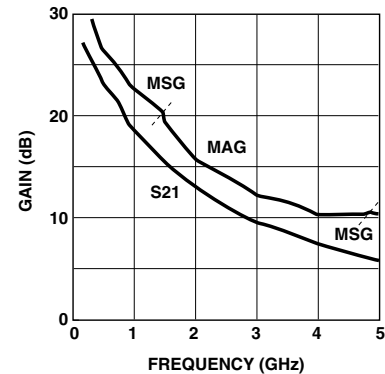

Figure 25. AT-31011 Gains vs. Frequency at  $V_{CE} = 5\text{ V}$ ,  $I_C = 10\text{ mA}$ .

**AT-31033 Typical Scattering Parameters,  $V_{CE} = 5\text{ V}$ ,  $I_C = 10\text{ mA}$ , Common Emitter,  $Z_O = 50\ \Omega$**

Freq. GHz	$S_{11}$			$S_{21}$			$S_{12}$		$S_{22}$	
	Mag	Ang	dB	Mag	Ang	dB	Mag	Ang	Mag	Ang
0.1	0.75	-19	26.79	21.84	155	-38.82	0.01	79	0.92	-10
0.5	0.37	-45	20.17	10.20	107	-27.39	0.04	73	0.67	-20
0.9	0.23	-42	15.79	6.16	90	-23.00	0.07	72	0.62	-22
1.0	0.21	-42	14.94	5.58	86	-22.11	0.08	72	0.61	-23
1.5	0.15	-30	11.75	3.87	73	-18.86	0.11	69	0.60	-27
1.8	0.14	-21	10.30	3.27	67	-17.37	0.14	66	0.59	-29
2.0	0.13	-17	9.47	2.97	63	-16.51	0.15	65	0.58	-31
2.4	0.13	-7	8.08	2.54	55	-15.00	0.18	62	0.57	-35
3.0	0.13	3	6.47	2.11	45	-13.14	0.22	57	0.56	-41
4.0	0.14	19	4.61	1.7	29	-10.67	0.29	48	0.53	-52
5.0	0.18	28	3.33	1.47	14	-8.73	0.37	38	0.49	-64

**AT-31033 Typical Noise Parameters,**

Common Emitter,  $Z_O = 50\ \Omega$ ,  $5\text{ V}$ ,  $I_C = 10\text{ mA}$

Freq GHz	$F_{min}^{[1]}$ dB	$\Gamma_{OPT}$		$R_n$
		Mag	Ang	
0.5 <sup>[2]</sup>	1.3	0.42	10	0.38
0.9	1.4	0.31	30	0.34
1.8	1.7	0.16	80	0.23
2.4	2.0	0.08	118	0.17

**Notes:**

1. Matching constraints may make  $F_{min}$  values associated with high  $|\Gamma_{OPT}|$  values unachievable in physical circuits. See Figure 2 for expected performance.
2. 0.5 GHz noise parameter values are extrapolated, not measured.

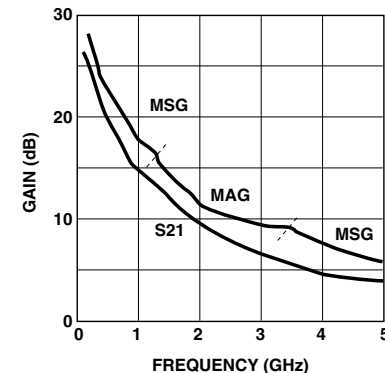

Figure 26. AT-31033 Gains vs. Frequency at  $V_{CE} = 5\text{ V}$ ,  $I_C = 10\text{ mA}$ .

## Ordering Information

Part Numbers	No. of Devices	Comments	
AT-31011-BLKG	AT-31033-BLKG	100	Bulk
AT-31011-TR1G	AT-31033-TR1G	3000	7" Reel
AT-31011-TR2G	AT-31033-TR2G	10000	13" Reel

## Package Dimensions

### SOT-23 Plastic Package

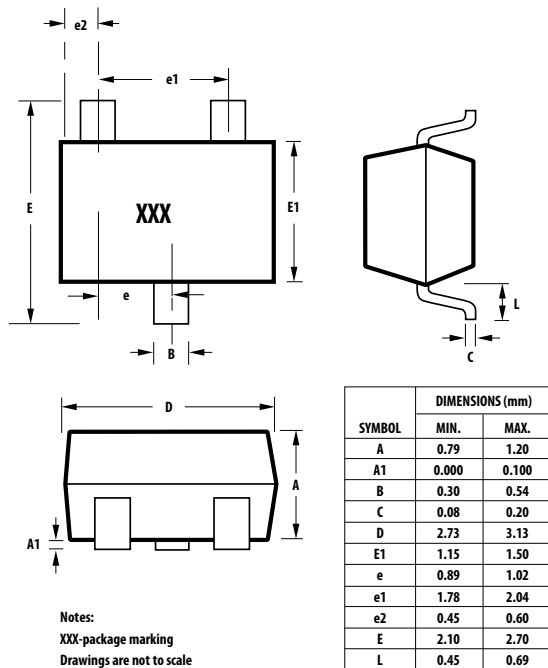

### SOT-143 Plastic Package

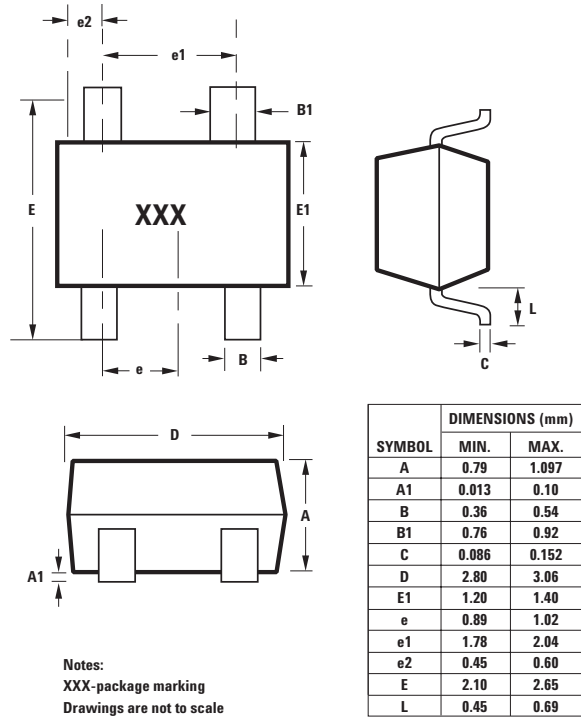

For product information and a complete list of distributors, please go to our web site: [www.avagotech.com](http://www.avagotech.com)

Avago, Avago Technologies, and the A logo are trademarks of Avago Technologies in the United States and other countries. Data subject to change. Copyright © 2005-2009 Avago Technologies. All rights reserved. Obsoletes 5989-2642EN AV02-0795EN - June 9, 2009

**Avago**  
TECHNOLOGIES