



Applications

- Motor Control
- Overvoltage Crowbar Protection
- Capacitive Discharge Ignition
- Voltage Regulation
- Welding Equipment
- Capacitive Filter Soft Start (Inrush Current Control)

- > Suitable for General Purpose AC Switching
- > IGT 35mA Max.
- > VDRM/VRMM 400, 600, 800, 1000V

CYNB55

55Amp - 400/600/800/1000V - **SCR**

Absolute Maximum Ratings

	CONDITIONS	SYMBOL	RATING
RMS On-State Current (full sine wave) ^{NOTE 1}	T _c = 70°C	T _O -220AB	I _{T(RMS)} 55A
Average On-State Current	T _c = 70°C	T _O -220AB	I _{T(AV)} 35A
Non Repetitive Surge Peak On-State Current (Full Cycle, T _j Initial = 25°C)	F = 50 Hz F = 60 Hz	I _{TSM}	675A 700A
I ² t Value for fusing	t _p = 10 ms	I ² t	2030A ² s
Critical rate of rise of on-state current I _G = 2 x I _{GT} , t _r < 100 ns, T _j = 125°C		di/dt	100A/μs
Peak Gate Current @ T _j = 125°C	t _p = 20 μs	I _{GM}	4A
Average Gate Power Dissipation @ T _j = 125°C		PG(AV)	1W
Storage Temperature Range		T _{stg}	-40 to +150°C
Operating Junction Temperature Range		T _j	-40 to +125°C
Maximum Peak Reverse Gate Voltage		V _{RGM}	5V

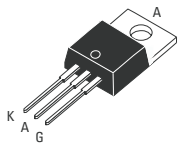

TO-220AB Non-Isolated (CYNB55)

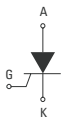

Electrical Characteristics ^{NOTE 2}

I _{GT} MAX @ V _D = 12 V, R _L = 30Ω		35mA
V _{GT} MAX @ V _D = 12 V, R _L = 30Ω		1.3V
V _{GD} MIN @ V _D = V _{DRM} , R _L = 3.3kΩ	T _j = 125°C	0.2V
I _H MAX @ I _T = 500 mA (gate open)		50mA
I _L MAX @ I _G = 1.2 I _{GT}		90mA
dv/dt MIN @ V _D = 67%V _{DRM} (gate open)	T _j = 125°C	1000V/μs
V _{TM} MAX @ I _{TM} = 78 A, t _p = 380μs	T _j = 25°C	1.6V
I _{DRM} MAX @ V _{DRM} = V _{RRM}	T _j = 25°C	5μA
I _{RRM} MAX @ V _{DRM} = V _{RRM}	T _j = 125°C	4mA

GENERAL NOTES

1. Not intended for continuous current use above 50A_{RMS} (Fig 2); for high surge conditions only, Continuous use above 50A_{RMS} may exceed PCB solder melting temperatures.
2. All parameters at 25 degrees C unless otherwise specified.

ISO9001 Certified



semi C3 Semiconductor, LLC

CYNB55

55Amp - 400/600/800/1000V - SCR

Thermal Resistances

		SYMBOL	RATING
Junction to Case (AC)	T0-220AB	$R_{th(j-c)}$	1.0°C/W
Junction to Ambient	T0-220AB	$R_{th(j-a)}$	60°C/W

Part Number Designation

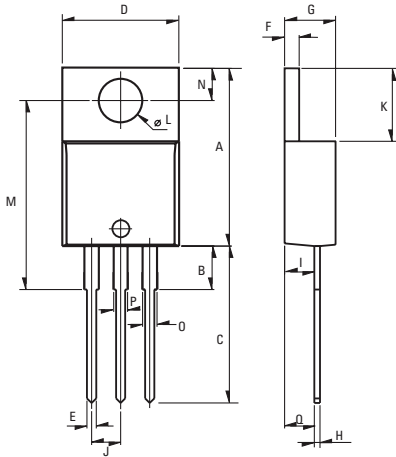
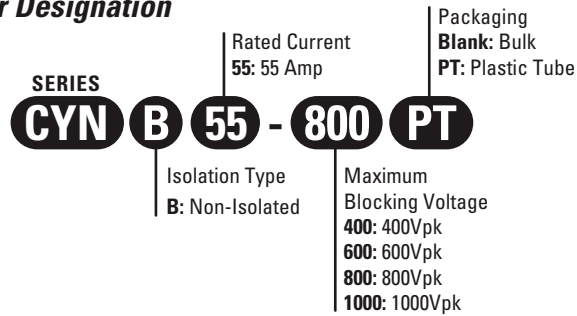

Weight: 2.3g (0.08 oz)

Dimensions

REF.	Millimeters			Inches		
	Min.	Typ.	Max.	Min.	Typ.	Max.
A	15.24		15.75	0.6		0.62
B		3.23			0.127	
C	12.78		13.79	0.503		0.543
D	9.96		10.36	0.392		0.408
E	0.69		0.94	0.027		0.037
F	1.22		1.32	0.048		0.052
G	4.62		4.83	0.182		0.19
H	0.46		0.61	0.018		0.024
I	2.49		2.84	0.098		0.112
J	2.39		2.69	0.094		0.106
K	6.48		6.88	0.255		0.271
L	3.78		3.89	0.149		0.153
M	15.49	16	16.51	0.61	0.63	0.65
N	2.59		2.9	0.102		0.114
O	0.99		1.55	0.039		0.061
P	0.99		1.55	0.039		0.061
Q		2.67			0.105	

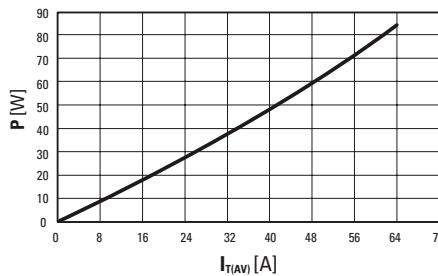

Fig. 1: Power dissipation versus average on-state current.

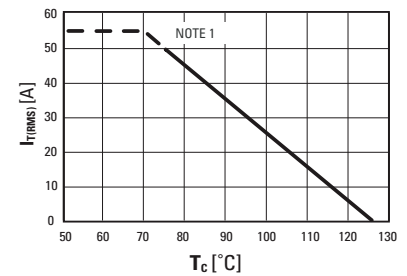

Fig. 2: RMS on-state current versus case temperature (full cycle)

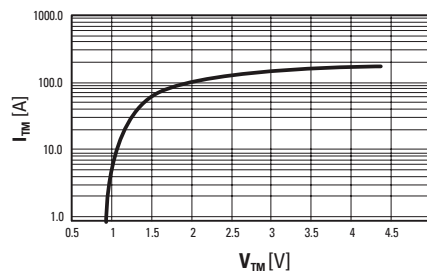

Fig. 3: On-state current versus on-state voltage (instantaneous values)

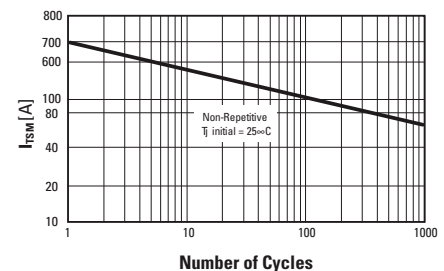

Fig. 4: Non-repetitive surge peak on-state current versus number of cycles.

ISO9001 Certified

© 2007 C3 Semiconductors, Specifications subject to change without notice.

Approvals

Pending

For recommended applications and more information contact:

USA : Sales Support (888) 882-8689

C3 Semiconductors, LLC. 2320 Paseo de las Americas, Ste. 104, San Diego, CA 92154

Email: sales@c3semi.com WEB SITE: <http://www.C3semi.com>