



SOLID STATE INC.

46 FARRAND STREET
BLOOMFIELD, NEW JERSEY 07003

www.solidstateinc.com

Silicon Controlled Rectifiers

Reverse Blocking Triode Thyristor

... multi-purpose PNP silicon controlled rectifiers suited for industrial, consumer, and military applications. Offered in a choice of space-saving, economical packages for mounting versatility.

- Uniform Low-Level Noise-Immune Gate Triggering — $I_{GT} = 10 \text{ mA (Typ) @ } T_C = 25^\circ\text{C}$
- Low Forward "On" Voltage — $v_T = 1 \text{ V (Typ) @ 5 Amp @ } 25^\circ\text{C}$
- High Surge-Current Capability — $I_{TSM} = 100 \text{ Amp Peak}$
- Shorted Emitter Construction

**2N4168
thru
2N4174**

**SCRs
8 AMPERES RMS
50 thru 600 VOLTS**

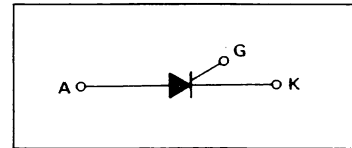

MAXIMUM RATINGS (Apply over operating temperature range and for all case types unless otherwise noted.)

Rating	Symbol	Value	Unit
*Peak Repetitive Forward and Reverse Blocking Voltage, Note 1	V_{DRM} or V_{RRM}	50 100 200 400 600	Volts
Forward Current RMS	$I_T(\text{RMS})$	8	Amps
*Peak Forward Surge Current (One cycle, 60 Hz, $T_J = -40$ to $+100^\circ\text{C}$)	I_{TSM}	100	Amps
Circuit Fusing ($T_J = -40$ to $+100^\circ\text{C}$; $t \leq 8.3 \text{ ms}$)	I^2t	40	A^2s
*Peak Gate Power	P_{GM}	5	Watts
*Average Gate Power	$P_{G(AV)}$	0.5	Watt
*Peak Gate Current	I_{GM}	2	Amps
Peak Gate Voltage, Note 2	V_{GM}	10	Volts
*Operating Temperature Range	T_J	-40 to +100	$^\circ\text{C}$
*Storage Temperature Range	T_{stg}	-40 to +150	$^\circ\text{C}$
Stud Torque		15	in. lb.

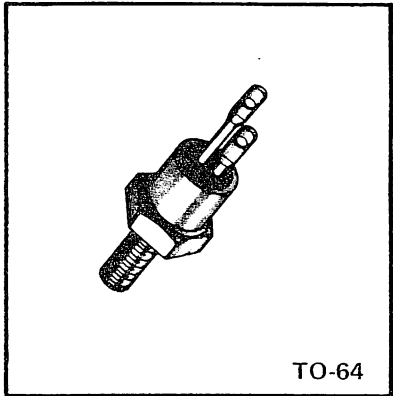

TO-64

*Indicates JEDEC Registered Data.

Notes: 1. Ratings apply for zero or negative gate voltage. Devices should not be tested for blocking capability in a manner such that the voltage applied exceeds the rated blocking voltage.

2. Devices should not be operated with a positive bias applied to the gate concurrently with a negative potential applied to the anode.

2N4168 thru 2N4174

THERMAL CHARACTERISTICS

Characteristic	Symbol	Typ	Max	Unit
Thermal Resistance, Junction to Case	$R_{\theta JC}$	1.5	2.5*	$^{\circ}C/W$
Thermal Resistance, Case to Ambient (See Figure 11) 2N4183-98	$R_{\theta CA}$	50	—	$^{\circ}C/W$

*Indicates JEDEC Registered Data.

ELECTRICAL CHARACTERISTICS ($T_C = 25^{\circ}C$ unless otherwise noted.)

Characteristic	Symbol	Min	Typ	Max	Unit
*Peak Forward or Reverse Blocking Current (Rated V_{DRM} or V_{RRM} , gate open) $T_J = 25^{\circ}C$ $T_J = 100^{\circ}C$	I_{DRM}, I_{RRM}	— —	— —	10 2	μA mA
Gate Trigger Current (Continuous dc), Note 1 ($V_D = 7 V_{dc}, R_L = 100 \Omega$) *($V_D = 7 V_{dc}, R_L = 100 \Omega, T_C = -40^{\circ}C$)	I_{GT}	— —	10 —	30 60	mA
Gate Trigger Voltage (Continuous dc) ($V_D = 7 V_{dc}, R_L = 100 \Omega$) *($V_D = 7 V_{dc}, R_L = 100 \Omega, T_C = -40^{\circ}C$) *($V_D = 7 V_{dc}, R_L = 100 \Omega, T_J = 100^{\circ}C$)	V_{GT}	— — 0.2	0.75 — —	1.5 2.5 —	Volts
*Forward "On" Voltage (pulsed, 1 ms max, duty cycle $\leq 1\%$) ($I_{TM} = 15.7 A$)	V_{TM}	—	1.4	2	Volts
Holding Current ($V_D = 7 V_{dc}$, gate open) *($V_D = 7 V_{dc}$, gate open, $T_C = -40^{\circ}C$)	I_H	— —	10 —	30 60	mA
Turn-On Time ($t_d + t_r$) ($I_G = 20 \text{ mAdc}, I_F = 5 \text{ Adc}, V_D = \text{Rated } V_{DRM}$)	t_{on}	—	1	—	μs
Turn-Off Time ($I_F = 5 \text{ Adc}, I_R = 5 \text{ Adc}$) ($I_F = 5 \text{ Adc}, I_R = 5 \text{ Adc}, T_J = 100^{\circ}C, V_D = \text{Rated } V_{DRM}$) ($dv/dt = 30 V/\mu s$)	t_{off}	— —	15 25	— —	μs
Forward Voltage Application Rate (Exponential) (Gate open, $T_J = 100^{\circ}C, V_D = \text{Rated } V_{DRM}$)	dv/dt	—	50	—	$V/\mu s$

*Indicates JEDEC Registered Data

Note 1. For optimum operation, i.e. faster turn-on, lower switching losses, best di/dt capability, recommended $I_{GT} = 200 \text{ mA}$ minimum.

TYPICAL TRIGGER CHARACTERISTICS

FIGURE 1 – PULSE CURRENT TRIGGERING

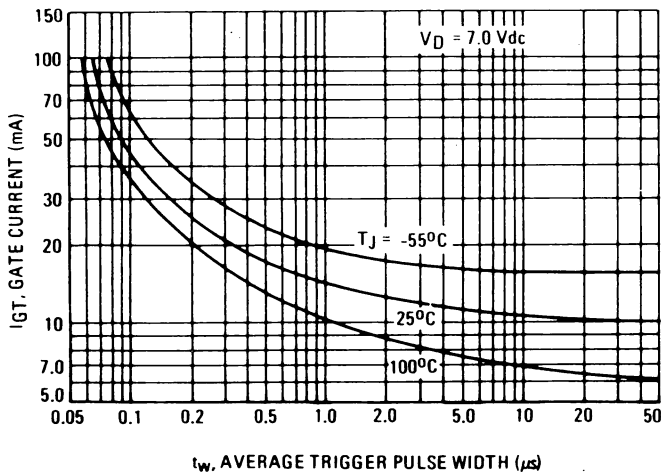
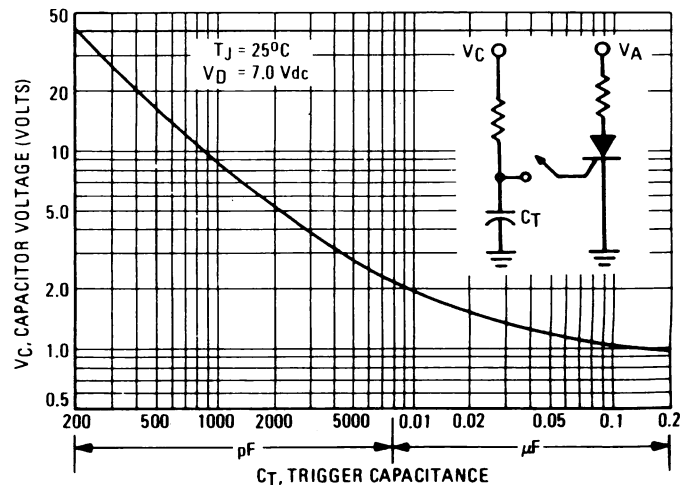

FIGURE 2 – CAPACITIVE DISCHARGE TRIGGERING



CURRENT DERATING

FIGURE 3 – MAXIMUM CASE TEMPERATURE

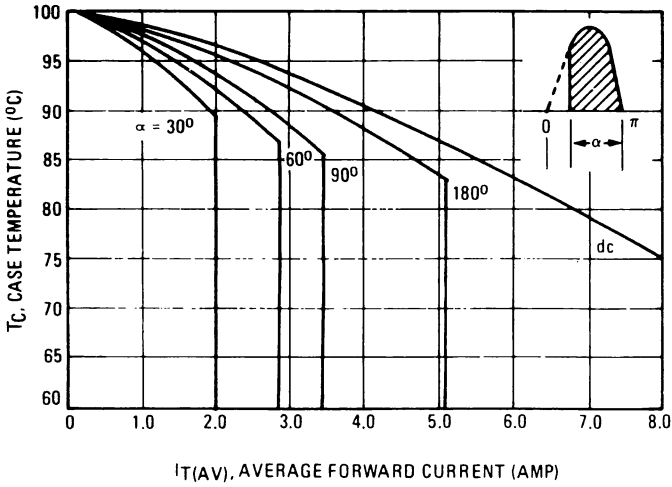

FIGURE 4 – MAXIMUM AMBIENT TEMPERATURE

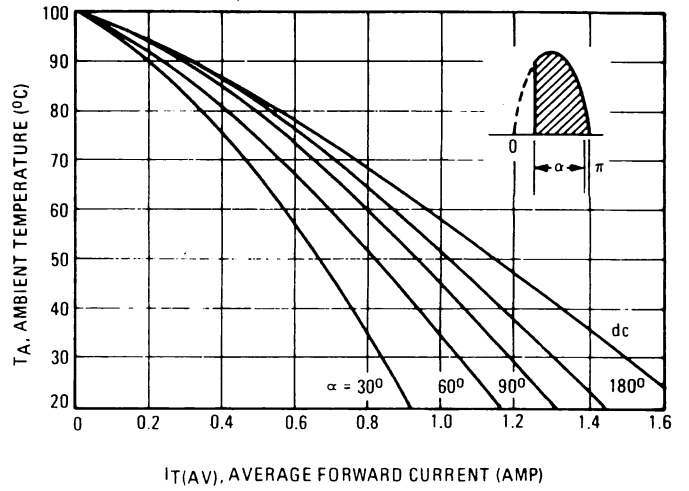

FIGURE 5 – POWER DISSIPATION

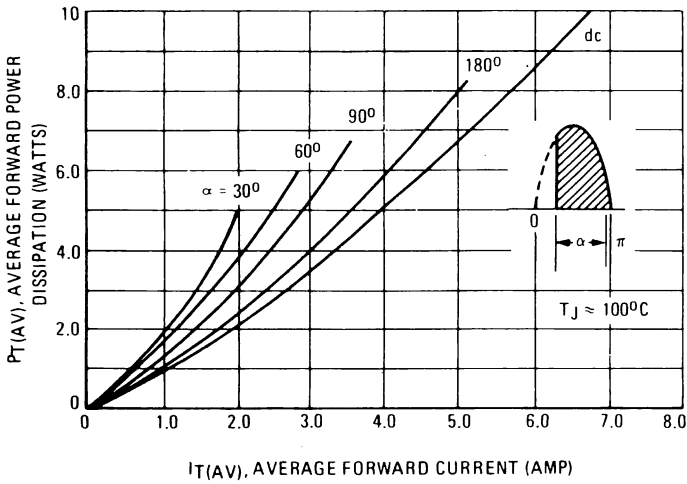

FIGURE 6 – MAXIMUM SURGE CAPABILITY

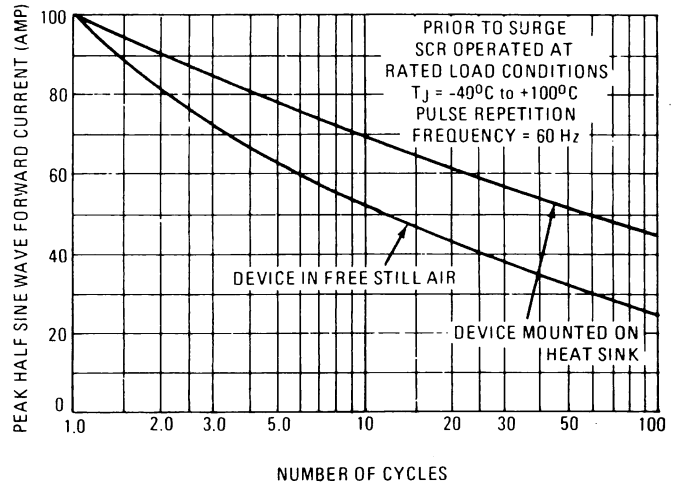
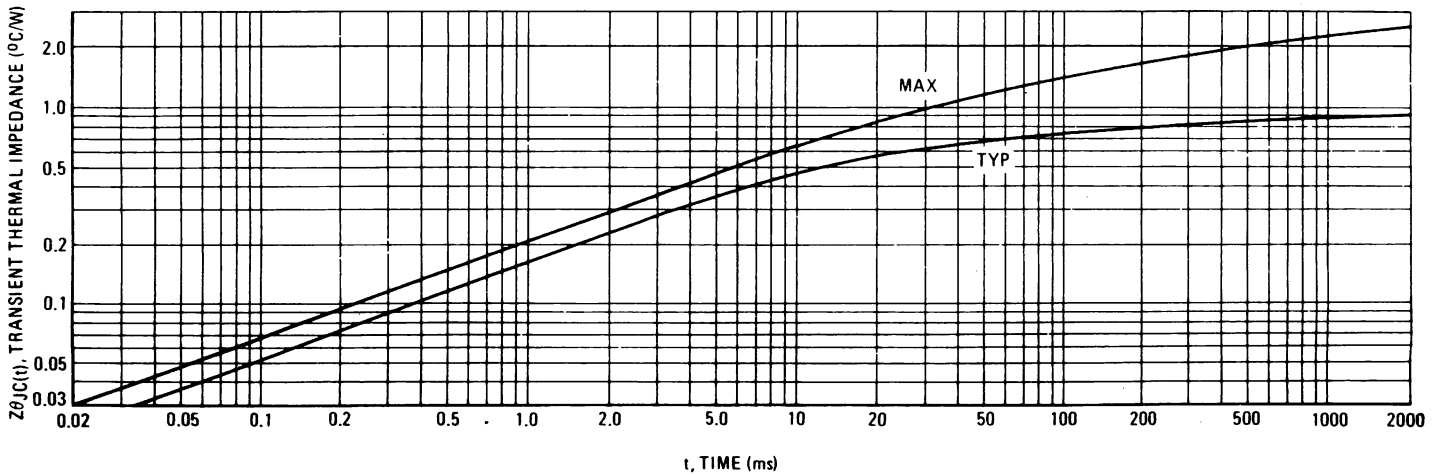

FIGURE 7 – THERMAL RESPONSE



2N4168 thru 2N4174

FIGURE 8 – FORWARD VOLTAGE

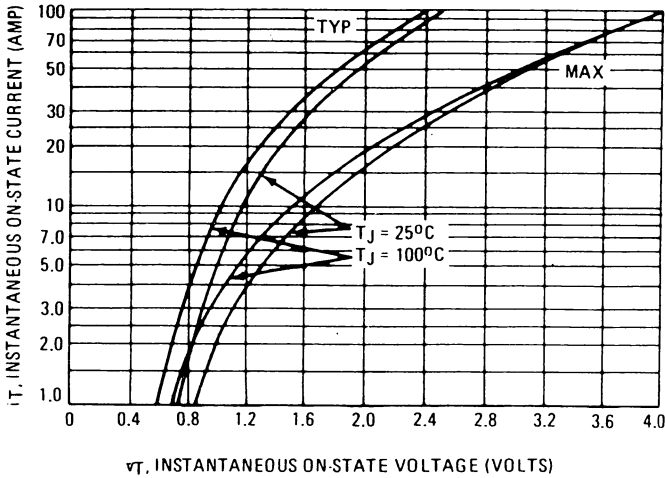

FIGURE 9 – HOLDING CURRENT

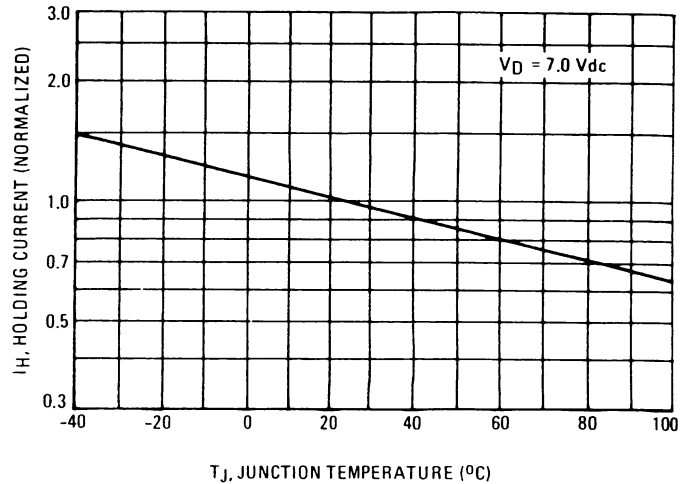

FIGURE 10 – TYPICAL THERMAL RESISTANCE OF PLATES

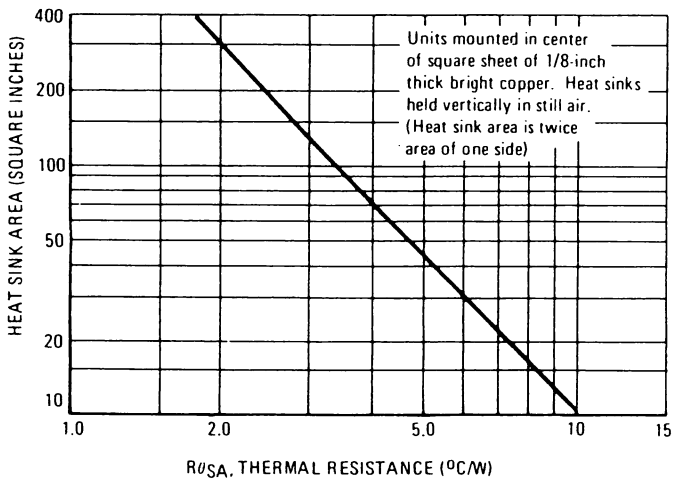
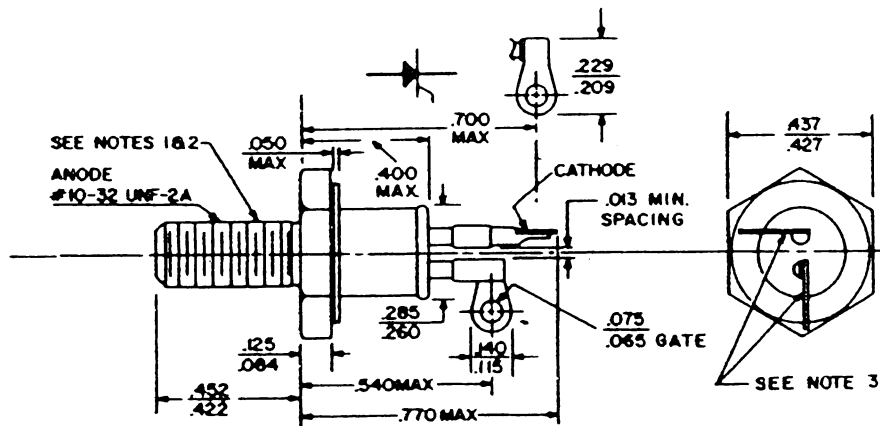
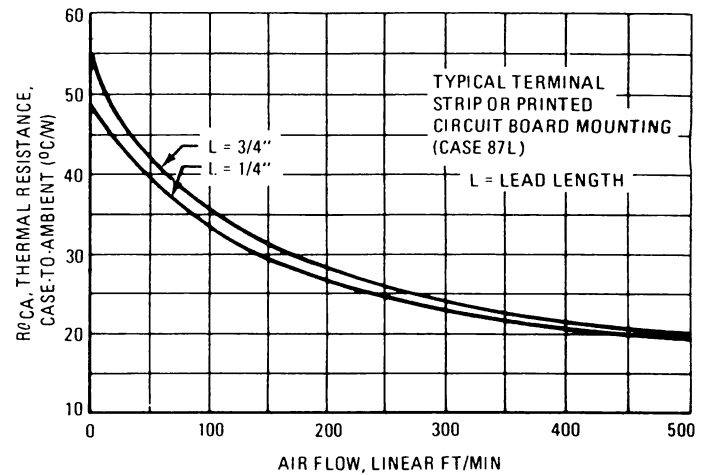

FIGURE 11 – CASE-TO-AMBIENT THERMAL RESISTANCE



- NOTES:**
1. COMPLETE THREADS EXTEND TO WITHIN 2-1/2 THREADS OF HEAD.
 2. DIAMETER OF UNTHREADED PORTION .190 MAX.
 3. ANGULAR ORIENTATION OF THESE TERMINALS IS UNDEFINED.
 4. CASE IS ANODE CONNECTION.
 5. ALL DIMENSIONS IN INCHES.