

SKT 100



Stud Thyristor

Line Thyristor

SKT 100

Features

- Hermetic metal case with glass insulator
- Threaded stud ISO M12 or UNF 1/2-20
- Interchangeable with international standard case

Typical Applications*

- DC motor control (e. g. for machines tools)
- Controlled rectifiers (e. g. for battery charging)
- AC controllers (e. g. for temperature control)
- Recommended snubber network e. g. for $V_{VRMS} \leq 400$ V:
 $R = 47 \Omega / 10$ W, $C = 0,22 \mu F$

1) Available with UNF thread 1/2-20 UNF2A, e. g. SKT 100/08D UNF

V_{RSM} V	V_{RRM}, V_{DRM} V	$I_{TRMS} = 175$ A (maximum value for continuous operation) $I_{TAV} = 100$ A (sin. 180; $T_c = 85$ °C)	
500	400	SKT 100/04D	
900	800	SKT 100/08D ¹⁾	
1300	1200	SKT 100/12E ¹⁾	
1500	1400	SKT 100/14E ¹⁾	
1700	1600	SKT 100/16E ¹⁾	
1900	1800	SKT 100/18E	

Symbol	Conditions	Values	Units
I_{TAV}	sin. 180; $T_c = 100$ (85) °C;	74 (100)	A
I_D	K1,1; $T_a = 45$ °C; B2 / B6	90 / 125	A
	K0,55; $T_a = 45$ °C; B2 / B6	130 / 180	A
I_{RMS}	K1,1; $T_a = 45$ °C; W1C	100	A
I_{TSM}	$T_{vj} = 25$ °C; 10 ms	2000	A
	$T_{vj} = 130$ °C; 10 ms	1750	A
i^2t	$T_{vj} = 25$ °C; 8,35 ... 10 ms	20000	A ² s
	$T_{vj} = 130$ °C; 8,35 ... 10 ms	15000	A ² s
V_T	$T_{vj} = 25$ °C; $I_T = 300$ A	max. 1,75	V
$V_{T(TO)}$	$T_{vj} = 130$ °C	max. 1	V
r_T	$T_{vj} = 130$ °C	max. 2,4	mΩ
$I_{DD}; I_{RD}$	$T_{vj} = 130$ °C; $V_{RD} = V_{RRM}; V_{DD} = V_{DRM}$	max. 30	mA
t_{gd}	$T_{vj} = 25$ °C; $I_G = 1$ A; $di_G/dt = 1$ A/μs	1	μs
t_{gr}	$V_D = 0,67 * V_{DRM}$	2	μs
$(di/dt)_{cr}$	$T_{vj} = 130$ °C	max. 50	A/μs
$(dv/dt)_{cr}$	$T_{vj} = 130$ °C; SKT ...D / SKT ...E	max. 500 / 1000	V/μs
t_q	$T_{vj} = 130$ °C	100	μs
I_H	$T_{vj} = 25$ °C; typ. / max.	150 / 250	mA
I_L	$T_{vj} = 25$ °C; typ. / max.	300 / 600	mA
V_{GT}	$T_{vj} = 25$ °C; d.c.	min. 3	V
I_{GT}	$T_{vj} = 25$ °C; d.c.	min. 150	mA
V_{GD}	$T_{vj} = 130$ °C; d.c.	max. 0,25	V
I_{GD}	$T_{vj} = 130$ °C; d.c.	max. 10	mA
$R_{th(j-c)}$	cont.	0,25	K/W
$R_{th(f-c)}$	sin. 180	0,28	K/W
$R_{th(j-c)}$	rec. 120	0,31	K/W
$R_{th(c-s)}$		0,08	K/W
T_{vj}		- 40 ... + 130	°C
T_{stg}		- 55 ... + 150	°C
V_{isol}		-	V~
M_s	to heatsink	16	Nm
a		5 * 9,81	m/s ²
m	approx.	100	g
Case		B 5	

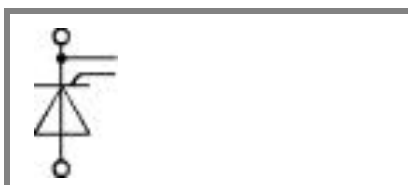

SKT

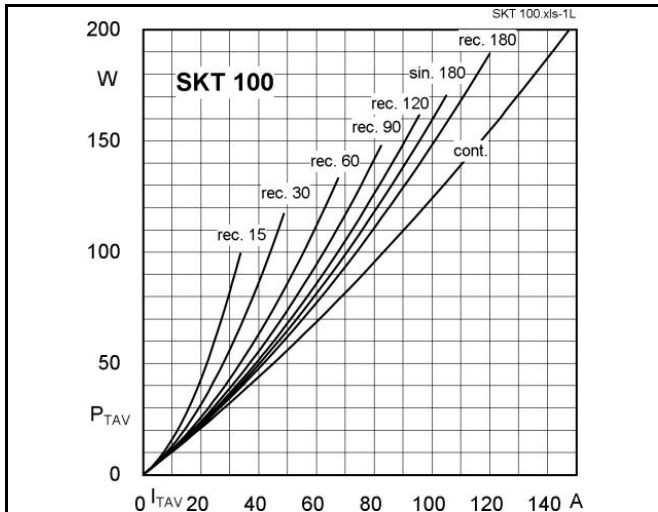

Fig. 1L Power dissipation vs. on-state current

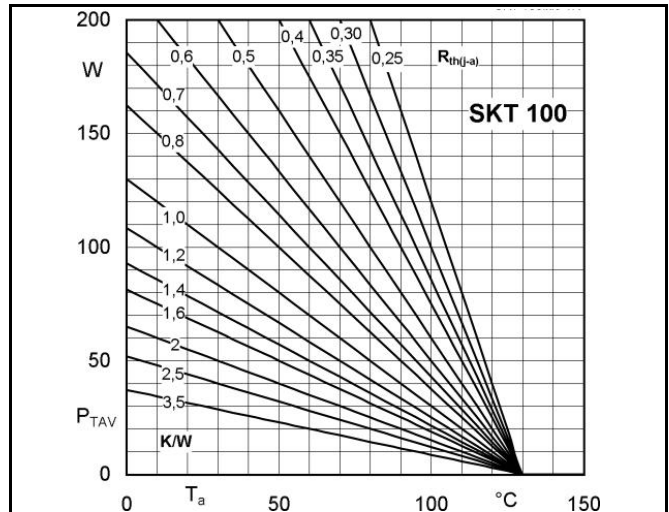

Fig. 1R Power dissipation vs. ambient temperature

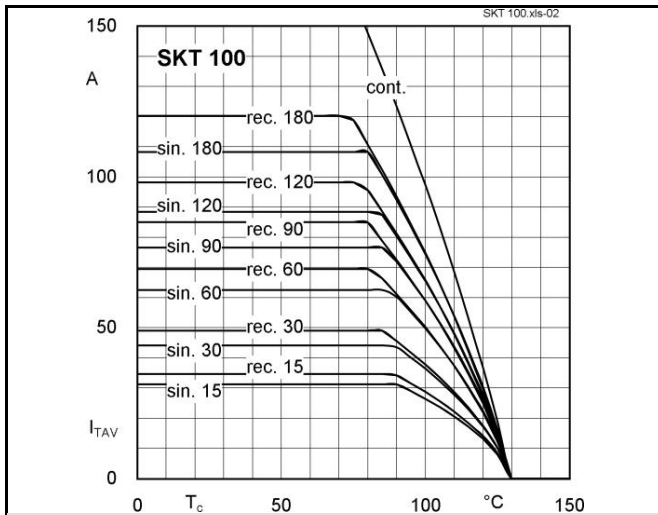

Fig. 2 Rated on-state current vs. case temperature

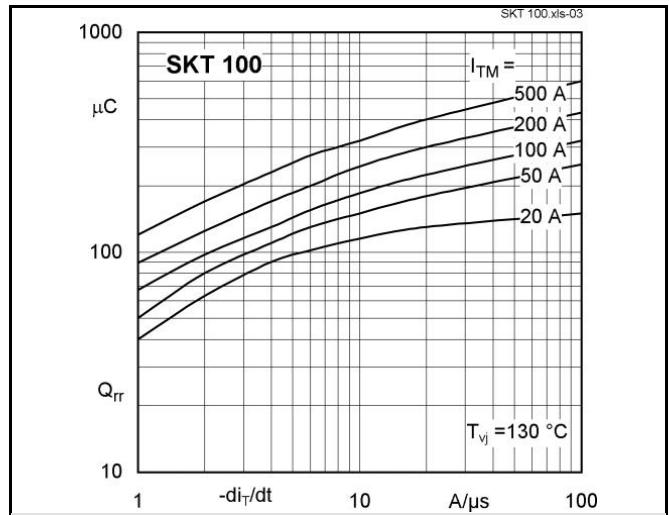

Fig. 3 Recovered charge vs. current decrease

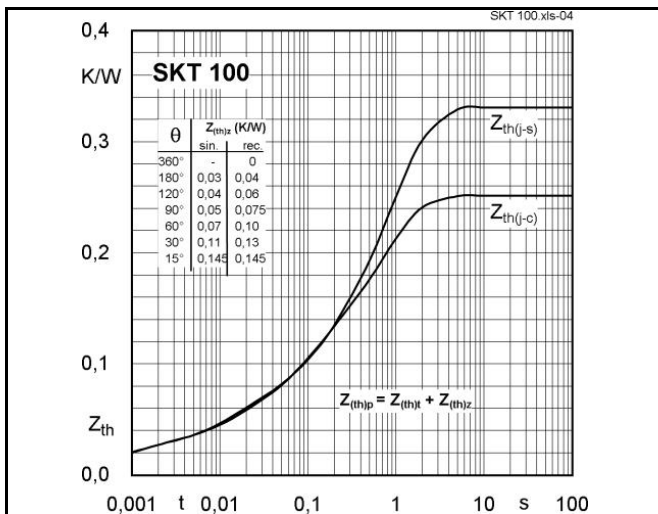

Fig. 4 Transient thermal impedance vs. time

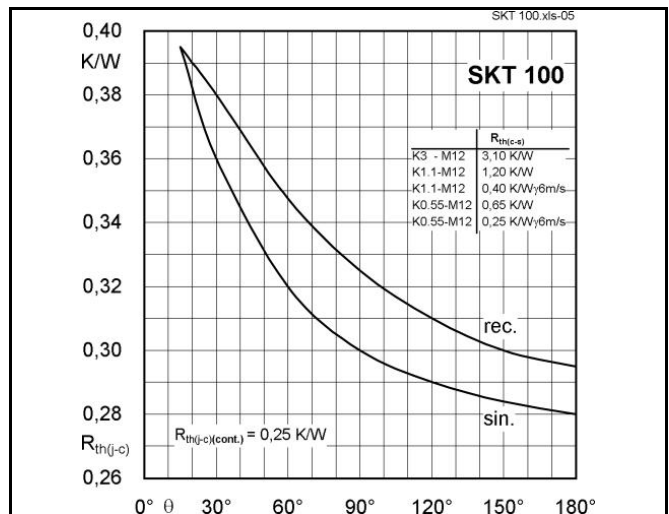

Fig. 5 Thermal resistance vs. conduction angle

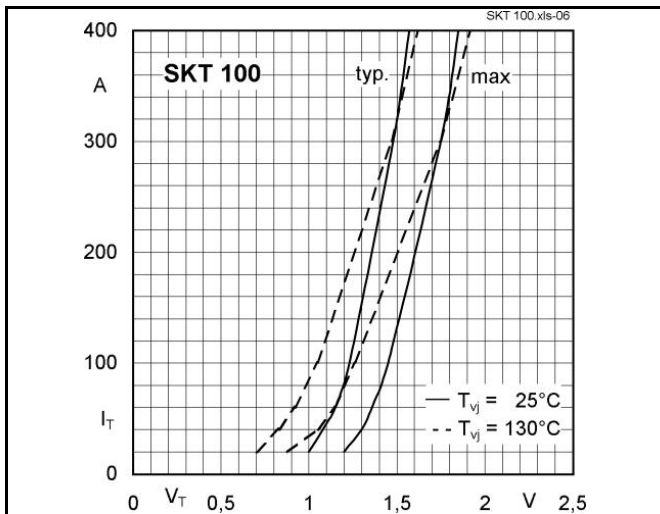

Fig. 6 On-state characteristics

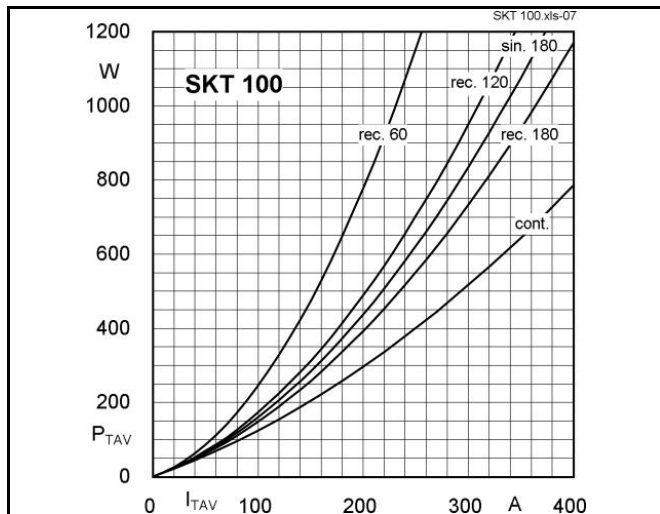

Fig. 7 Power dissipation vs. on-state current

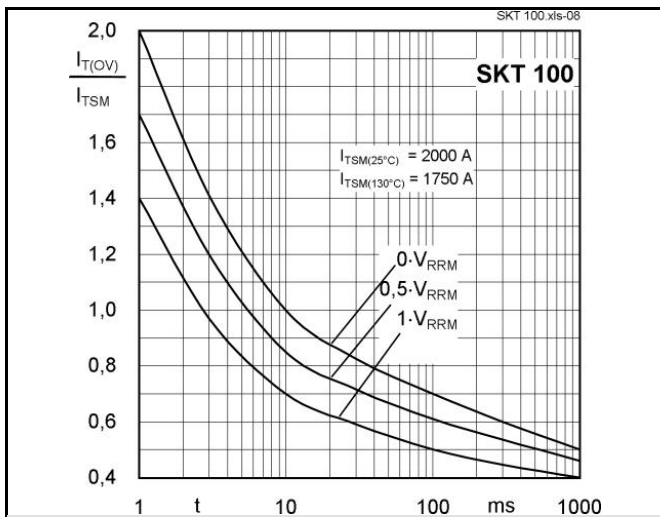
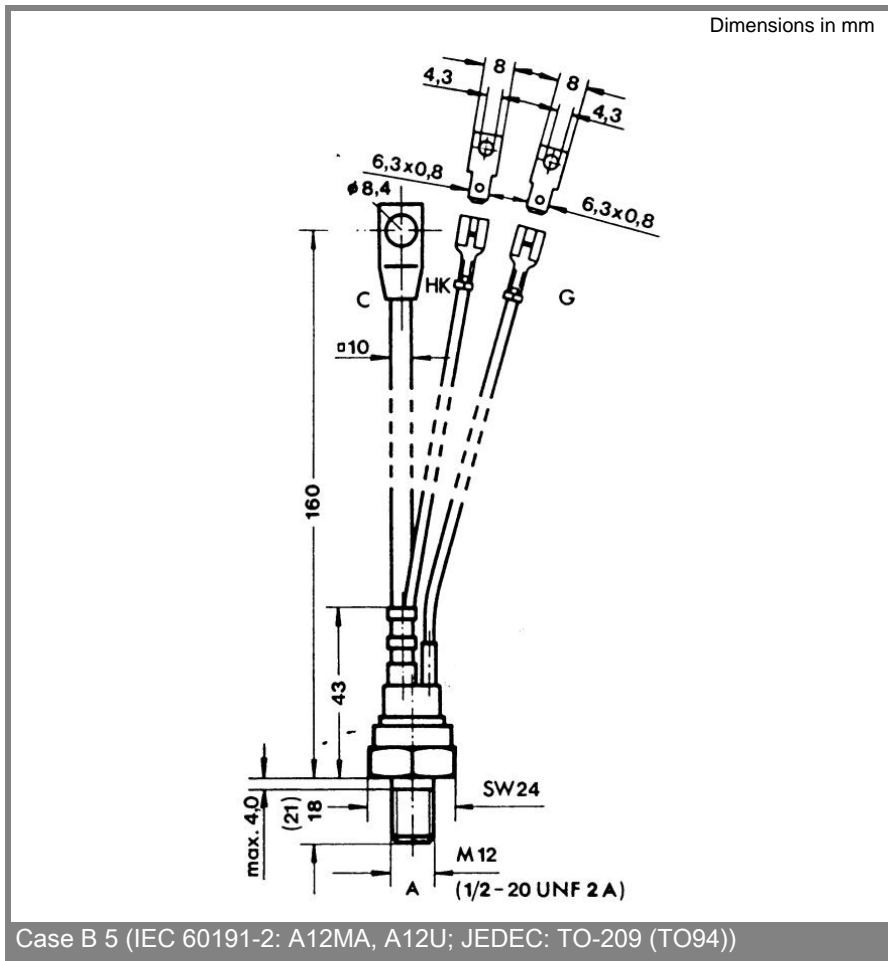
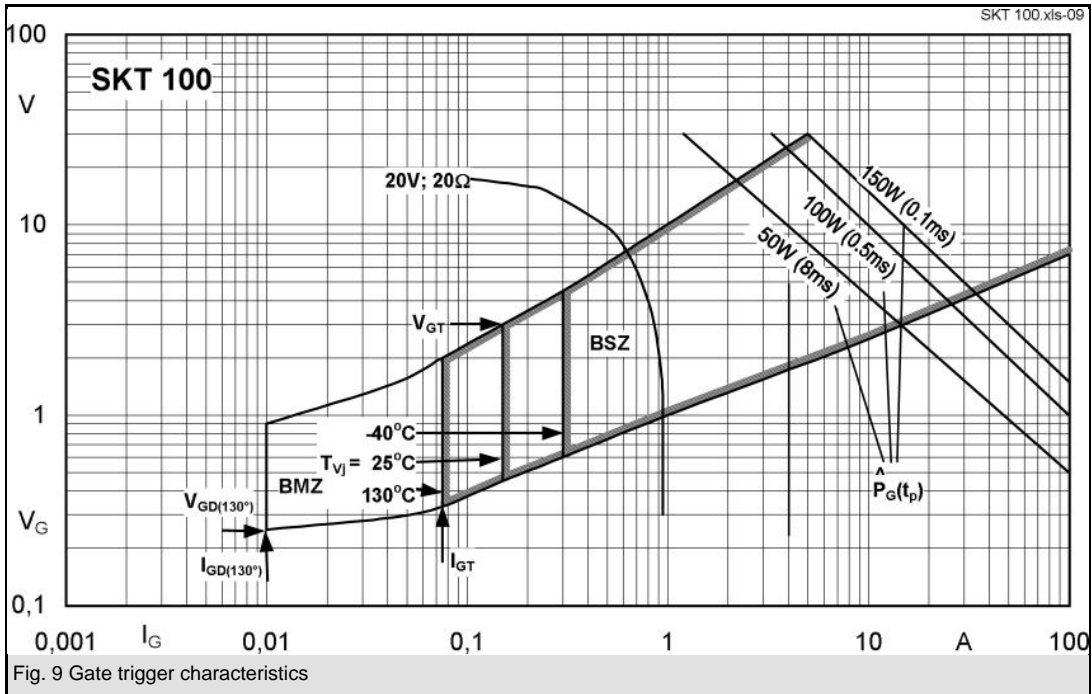

Fig. 8 Surge overload current vs. time



* The specifications of our components may not be considered as an assurance of component characteristics. Components have to be tested for the respective application. Adjustments may be necessary. The use of SEMIKRON

products in life support appliances and systems is subject to prior specification and written approval by SEMIKRON. We therefore strongly recommend prior consultation of our personal.