



**Applications**

- Motor Control
- Overvoltage Crowbar Protection
- Capacitive Discharge Ignition
- Voltage Regulation
- Welding Equipment
- Capacitive Filter Soft Start (Inrush Current Control)

> Suitable for General Purpose AC Switching

> IGT 25 mA Max.

> VDRM/VRMM 400, 600, 800, 1000V

# CYNA/CYNB16

16Amp - 400/600/800/1000V - SCR

**Absolute Maximum Ratings**

	CONDITIONS	SYMBOL	RATING
RMS On-State Current (full sine wave)	T <sub>c</sub> = 110°C T <sub>c</sub> = 95°C TO-220AB TO-220AB Iso	I <sub>T(RMS)</sub>	16A
Average On-State Current	T <sub>c</sub> = 110°C T <sub>c</sub> = 95°C TO-220AB TO-220AB Iso	I <sub>T(AV)</sub>	10A
Non Repetitive Surge Peak On-State Current (Full Cycle, T <sub>j</sub> Initial = 25°C)	F = 50 Hz F = 60 Hz	I <sub>TSM</sub>	190A 200A
I <sup>2</sup> t Value for fusing	tp = 10 ms	I <sup>2</sup> t	180A <sup>2</sup> s
Critical rate of rise of on-state current I <sub>G</sub> = 2 x I <sub>GT</sub> , tr < 100 ns, T <sub>j</sub> = 125°C		di/dt	100A/μs
Peak Gate Current @ T <sub>j</sub> = 125°C	tp = 20 μs	I <sub>GM</sub>	4A
Average Gate Power Dissipation @ T <sub>j</sub> = 125°C		PG(AV)	1W
Storage Temperature Range		T <sub>stg</sub>	-40 to +150°C
Operating Junction Temperature Range		T <sub>j</sub>	-40 to +125°C
Isolation Voltage (CYNA Series only)		V <sub>ISO</sub>	2500V <sub>RMS</sub>
Maximum Peak Reverse Gate Voltage		V <sub>RGM</sub>	5V

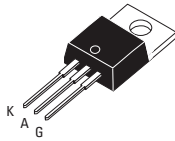

TO-220AB Isolated (CYNA25)

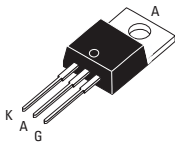

TO-220AB Non-Isolated (CYNB25)

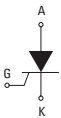

**Electrical Characteristics** <sup>NOTE 1</sup>

I <sub>GT</sub> MAX @ V <sub>D</sub> = 12 V, R <sub>L</sub> = 30Ω		25mA
V <sub>GT</sub> MAX @ V <sub>D</sub> = 12 V, R <sub>L</sub> = 30Ω		1.3V
V <sub>GD</sub> MIN @ V <sub>D</sub> = V <sub>DRM</sub> , R <sub>L</sub> = 3.3kΩ	T <sub>j</sub> = 125°C	0.2V
I <sub>H</sub> MAX @ I <sub>T</sub> = 500 mA (gate open)		40mA
I <sub>L</sub> MAX @ I <sub>G</sub> = 1.2 I <sub>GT</sub>		60mA
dv/dt MIN @ V <sub>D</sub> = 67%V <sub>DRM</sub> (gate open)	T <sub>j</sub> = 125°C	500V/μs
V <sub>TM</sub> MAX @ I <sub>TM</sub> = 32 A, tp = 380μs	T <sub>j</sub> = 25°C	1.6V
I <sub>DRM</sub> MAX @ V <sub>DRM</sub> = V <sub>RRM</sub>	T <sub>j</sub> = 25°C	5μA
I <sub>RRM</sub> MAX @ V <sub>DRM</sub> = V <sub>RRM</sub>	T <sub>j</sub> = 125°C	2mA

**GENERAL NOTES**

1. All parameters at 25 degrees C unless otherwise specified.

ISO9001 Certified



semi C3 Semiconductor, LLC

# CYNA/CYNB16

16Amp - 400/600/800/1000V - SCR

## Thermal Resistances

		SYMBOL	RATING
Junction to Case (AC)	TO-220AB	$R_{th(j-c)}$	1.2°C/W
Junction to Case (AC)	TO-220AB Isolated	$R_{th(j-c)}$	2.1°C/W
Junction to Ambient	TO-220AB	$R_{th(j-a)}$	60°C/W
Junction to Ambient	TO-220AB Isolated	$R_{th(j-a)}$	60°C/W

## Part Number Designation

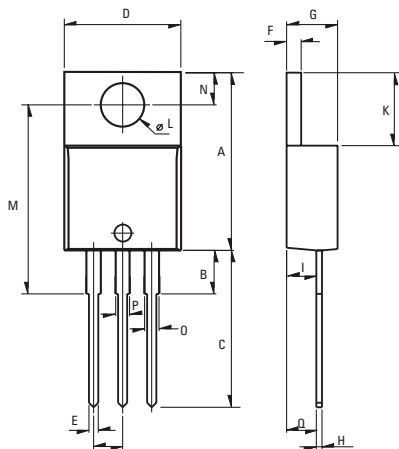
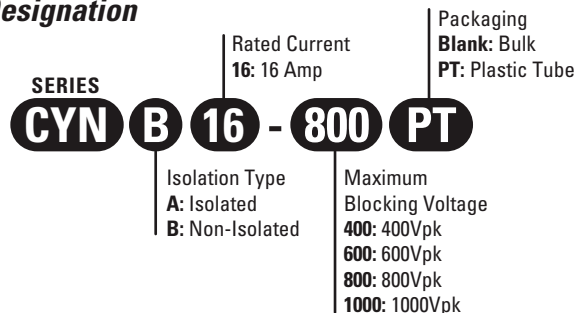

Weight: 2.3g (0.08 oz)

## Dimensions

REF.	Millimeters			Inches		
	Min.	Typ.	Max.	Min.	Typ.	Max.
A	15.24		15.75	0.6		0.62
B		3.23			0.127	
C	12.78		13.79	0.503		0.543
D	9.96		10.36	0.392		0.408
E	0.69		0.94	0.027		0.037
F	1.22		1.32	0.048		0.052
G	4.62		4.83	0.182		0.19
H	0.46		0.61	0.018		0.024
I	2.49		2.84	0.098		0.112
J	2.39		2.69	0.094		0.106
K	6.48		6.88	0.255		0.271
L	3.78		3.89	0.149		0.153
M	15.49	16	16.51	0.61	0.63	0.65
N	2.59		2.9	0.102		0.114
O	0.99		1.55	0.039		0.061
P	0.99		1.55	0.039		0.061
Q		2.67			0.105	

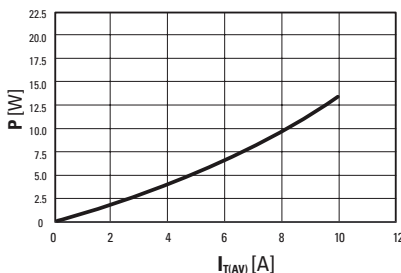

Fig. 1: Power dissipation versus average on-state current.

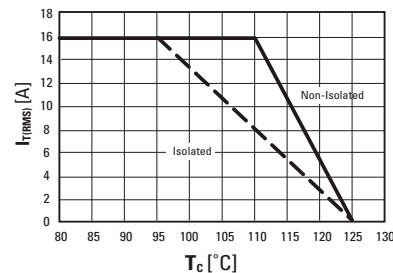

Fig. 2: RMS on-state current versus case temperature (full cycle)

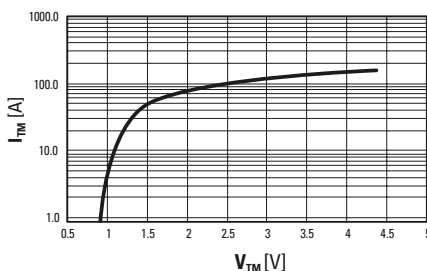

Fig. 3: On-state current versus on-state voltage (instantaneous values)

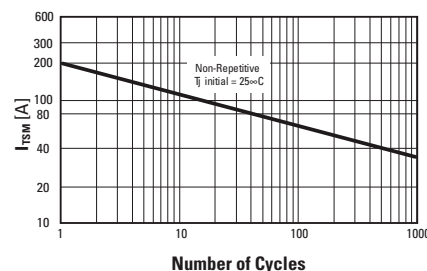

Fig. 4: Non-repetitive surge peak on-state current versus number of cycles.

ISO9001 Certified

© 2007 C3 Semiconductors, Specifications subject to change without notice.

## Approvals

UL Recognized Component - E72445  
(For CYNA series)

For recommended applications and more information contact:  
 USA : Sales Support (888) 882-8689  
 C3 Semiconductors, LLC. 2320 Paseo de las Americas, Ste. 104, San Diego, CA 92154  
 Email: sales@c3semi.com WEB SITE: http://www.C3semi.com