



N-Channel 100-V (D-S) 175°C MOSFET

PRODUCT SUMMARY		
$V_{(BR)DSS}$ (V)	$r_{DS(on)}$ (Ω)	I_D (A)
100	0.016 @ $V_{GS} = 10$ V	60
	0.018 @ $V_{GS} = 4.5$ V	56

FEATURES

- TrenchFET® Power MOSFET
- 175°C Junction Temperature
- PWM Optimized

APPLICATIONS

- DC/DC Primary Side Switch

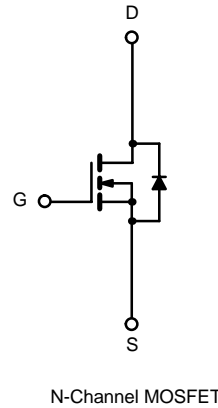
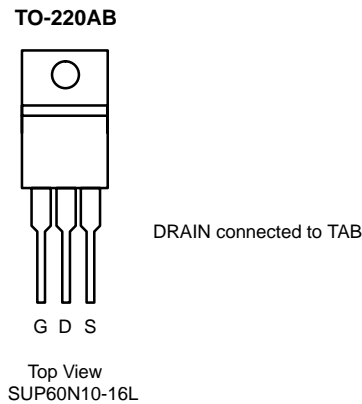

ABSOLUTE MAXIMUM RATINGS ($T_C = 25^\circ\text{C}$ UNLESS OTHERWISE NOTED)			
Parameter	Symbol	Limit	Unit
Drain-Source Voltage	V_{DS}	100	V
Gate-Source Voltage	V_{GS}	± 20	
Continuous Drain Current ($T_J = 175^\circ\text{C}$)	I_D	$T_C = 25^\circ\text{C}$	60
		$T_C = 125^\circ\text{C}$	35
Pulsed Drain Current	I_{DM}	100	A
Avalanche Current	I_{AR}	40	
Repetitive Avalanche Energy ^a	E_{AR}	80	mJ
Maximum Power Dissipation ^a	P_D	150 ^b	W
Operating Junction and Storage Temperature Range	T_J, T_{stg}	-55 to 175	$^\circ\text{C}$

THERMAL RESISTANCE RATINGS			
Parameter	Symbol	Limit	Unit
Junction-to-Ambient (Free Air)	R_{thJA}	62.5	$^\circ\text{C/W}$
Junction-to-Case	R_{thJC}	1.0	

Notes

- Duty cycle $\leq 1\%$.
- See SOA curve for voltage derating.
- When mounted on 1" square PCB (FR-4 material).

SPECIFICATIONS (T _J = 25 °C UNLESS OTHERWISE NOTED)						
Parameter	Symbol	Test Condition	Min	Typ	Max	Unit
Static						
Drain-Source Breakdown Voltage	V _{(BR)DSS}	V _{GS} = 0 V, I _D = 250 μA	100			V
Gate-Threshold Voltage	V _{GS(th)}	V _{DS} = V _{GS} , I _D = 250 μA	1		3	
Gate-Body Leakage	I _{GSS}	V _{DS} = 0 V, V _{GS} = ±20 V			±100	nA
Zero Gate Voltage Drain Current	I _{DSS}	V _{DS} = 80 V, V _{GS} = 0 V			1	μA
		V _{DS} = 80 V, V _{GS} = 0 V, T _J = 125 °C			50	
		V _{DS} = 80 V, V _{GS} = 0 V, T _J = 175 °C			250	
On-State Drain Current ^a	I _{D(on)}	V _{DS} ≥ 5 V, V _{GS} = 10 V	100			A
Drain-Source On-State Resistance ^a	r _{DS(on)}	V _{GS} = 10 V, I _D = 30 A		0.0125	0.016	Ω
		V _{GS} = 4.5 V, I _D = 20 A		0.014	0.018	
		V _{GS} = 10 V, I _D = 30 A, T _J = 125 °C			0.030	
		V _{GS} = 10 V, I _D = 30 A, T _J = 175 °C			0.040	
Forward Transconductance ^a	g _{fs}	V _{DS} = 15 V, I _D = 30 A	25			S
Dynamic^b						
Input Capacitance	C _{iss}	V _{GS} = 0 V, V _{DS} = 25 V, f = 1 MHz		3820		pF
Output Capacitance	C _{oss}			450		
Reverse Transfer Capacitance	C _{rss}			210		
Total Gate Charge ^c	Q _g	V _{DS} = 50 V, V _{GS} = 10 V, I _D = 60 A		73	110	nC
Gate-Source Charge ^c	Q _{gs}			15		
Gate-Drain Charge ^c	Q _{gd}			20		
Gate Resistance	R _G			1.5		Ω
Turn-On Delay Time ^c	t _{d(on)}	V _{DD} = 50 V, R _L = 0.83 Ω I _D ≅ 60 A, V _{GEN} = 10 V, R _G = 2.5 Ω		12	25	ns
Rise Time ^c	t _r			90	135	
Turn-Off Delay Time ^c	t _{d(off)}			55	85	
Fall Time ^c	t _f			130	195	
Source-Drain Diode Ratings and Characteristics (T_C = 25 °C)^b						
Continuous Current	I _S				60	A
Pulsed Current	I _{SM}				100	
Forward Voltage ^a	V _{SD}	I _F = 60 A, V _{GS} = 0 V		1.0	1.5	V
Reverse Recovery Time	t _{rr}	I _F = 50 A, di/dt = 100 A/μs		62	100	ns
Peak Reverse Recovery Current	I _{RM(REC)}			3.1	5	A
Reverse Recovery Charge	Q _{rr}			0.10	0.25	μC

Notes

- a. Pulse test; pulse width ≤ 300 μs, duty cycle ≤ 2%.
- b. Guaranteed by design, not subject to production testing.
- c. Independent of operating temperature.

TYPICAL CHARACTERISTICS (25°C UNLESS NOTED)

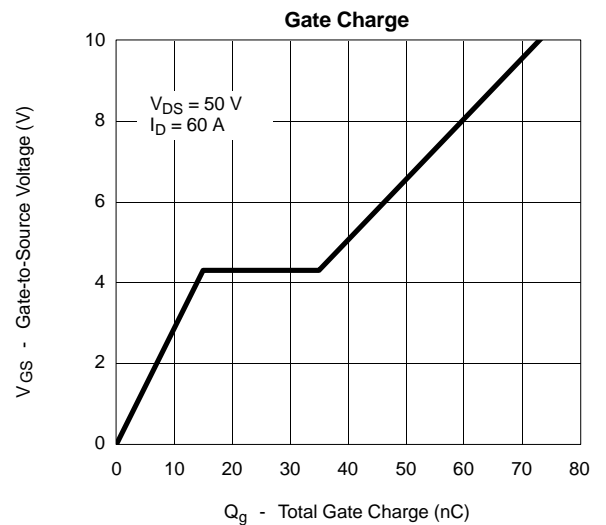
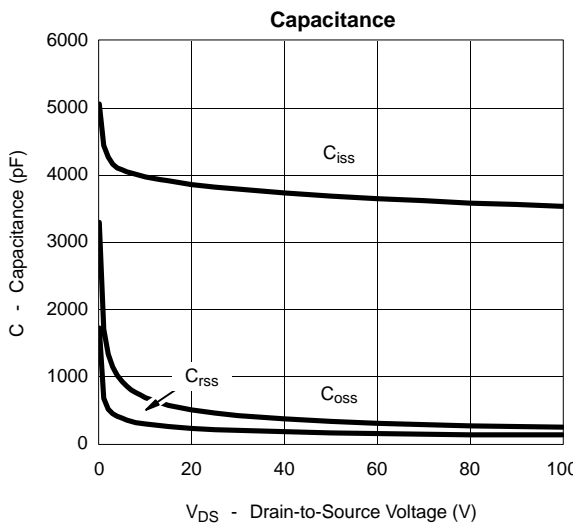
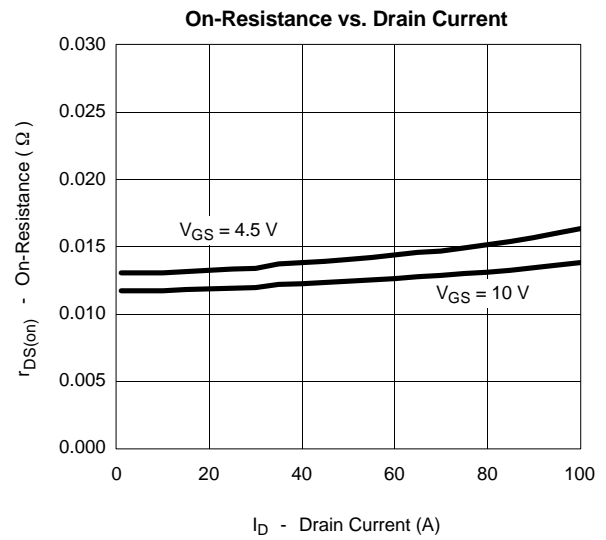
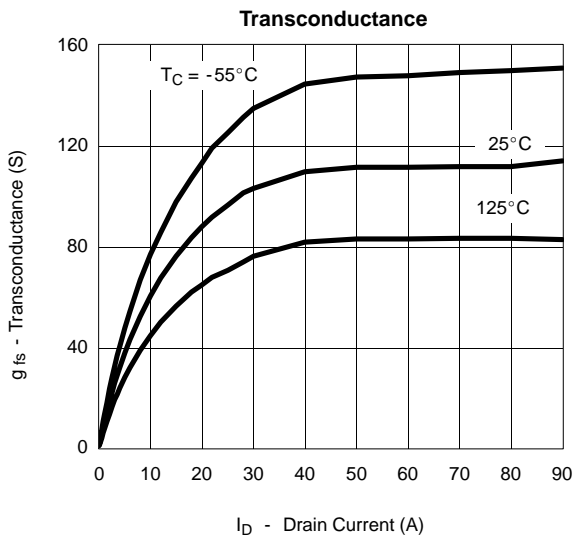
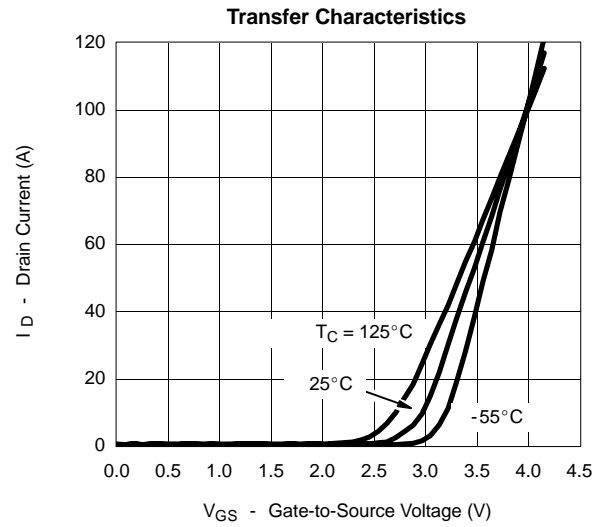
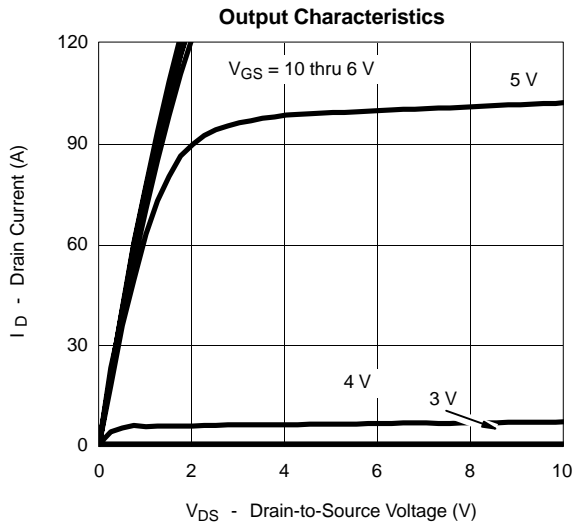

TYPICAL CHARACTERISTICS (25 °C UNLESS NOTED)

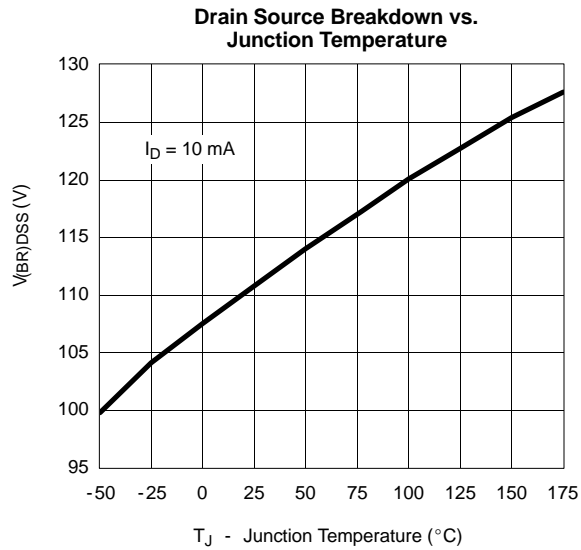
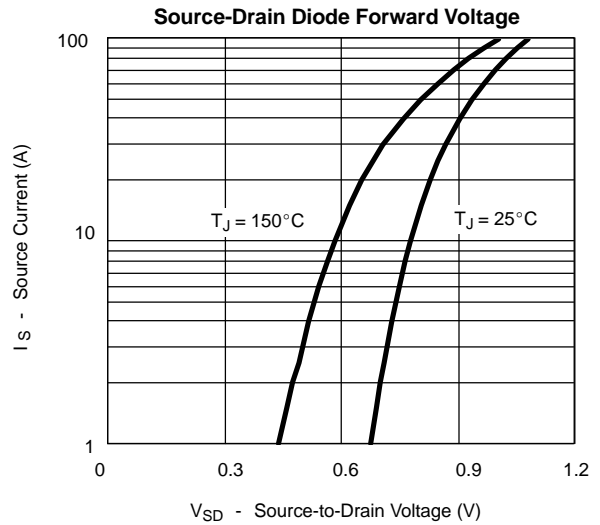
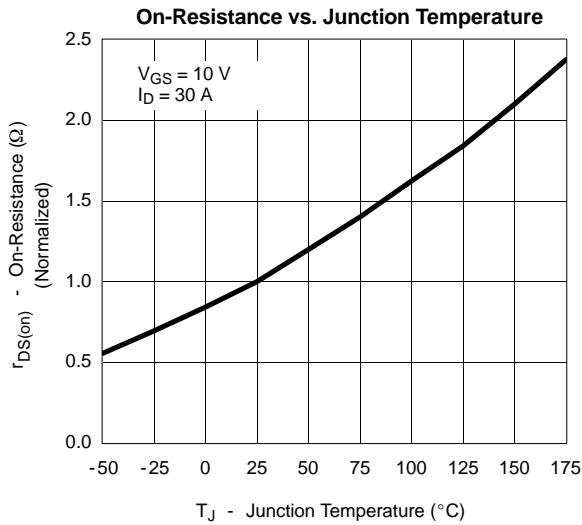

THERMAL RATINGS

Maximum Avalanche and Drain Current vs. Case Temperature

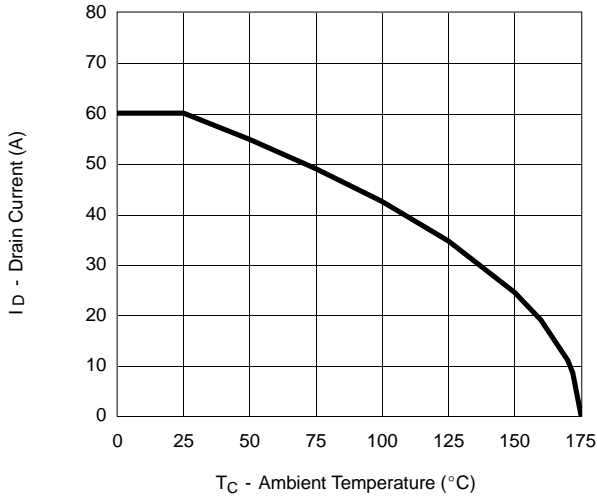

Safe Operating Area

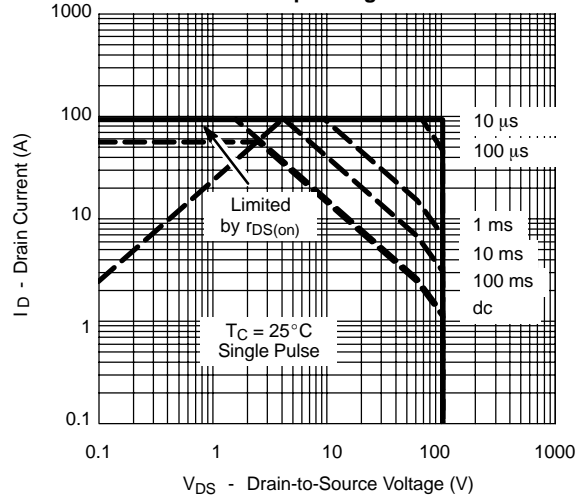

Normalized Thermal Transient Impedance, Junction-to-Case

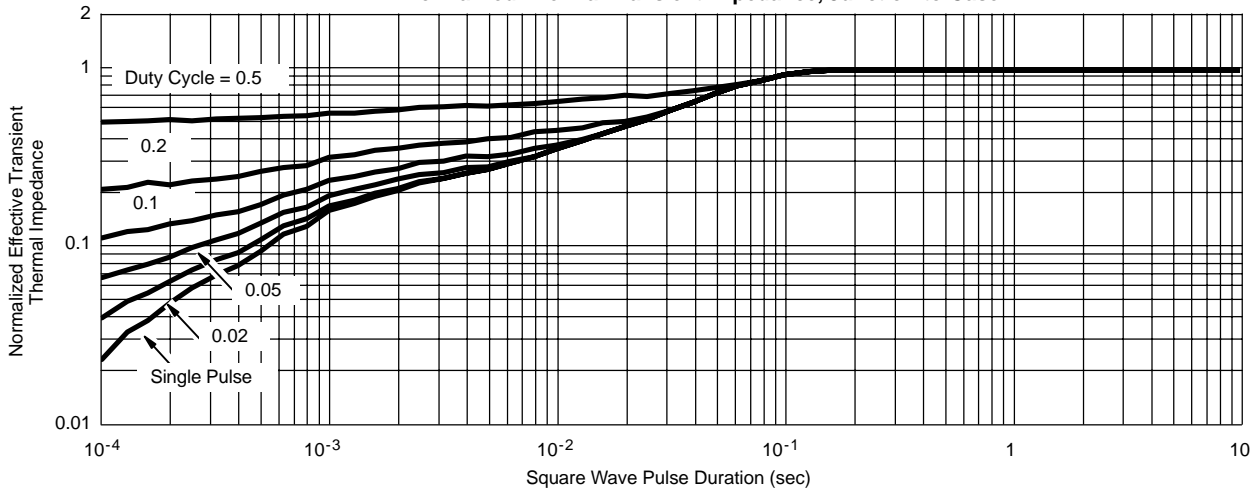



Disclaimer

All product specifications and data are subject to change without notice.

Vishay Intertechnology, Inc., its affiliates, agents, and employees, and all persons acting on its or their behalf (collectively, "Vishay"), disclaim any and all liability for any errors, inaccuracies or incompleteness contained herein or in any other disclosure relating to any product.

Vishay disclaims any and all liability arising out of the use or application of any product described herein or of any information provided herein to the maximum extent permitted by law. The product specifications do not expand or otherwise modify Vishay's terms and conditions of purchase, including but not limited to the warranty expressed therein, which apply to these products.

No license, express or implied, by estoppel or otherwise, to any intellectual property rights is granted by this document or by any conduct of Vishay.

The products shown herein are not designed for use in medical, life-saving, or life-sustaining applications unless otherwise expressly indicated. Customers using or selling Vishay products not expressly indicated for use in such applications do so entirely at their own risk and agree to fully indemnify Vishay for any damages arising or resulting from such use or sale. Please contact authorized Vishay personnel to obtain written terms and conditions regarding products designed for such applications.

Product names and markings noted herein may be trademarks of their respective owners.