

Bi-Directional P-Channel 20-V (D-S) MOSFET

PRODUCT SUMMARY		
V_{S1S2} (V)	$R_{S1S2(on)}$ (Ω)	I_{S1S2} (A)
- 20	0.060 at $V_{GS} = - 4.5$ V	- 4.4
	0.080 at $V_{GS} = - 2.5$ V	- 3.9
	0.105 at $V_{GS} = - 1.8$ V	- 3.4

FEATURES

- TrenchFET® Power MOSFET
- Ultra-Low $R_{SS(on)}$
- ESD Protected: 6000 V
- MICRO FOOT® Chipscale Packaging
Reduces Footprint Area, Profile (0.65 mm)
and On-Resistance Per Footprint Area



RoHS
COMPLIANT

APPLICATIONS

- Smart Batteries for Portable Devices

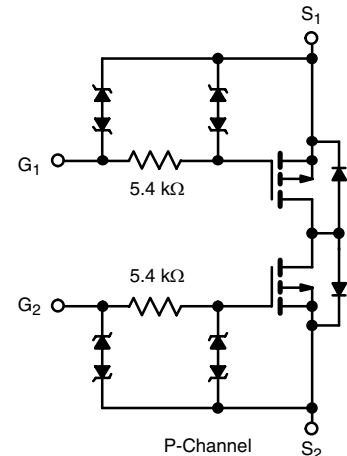
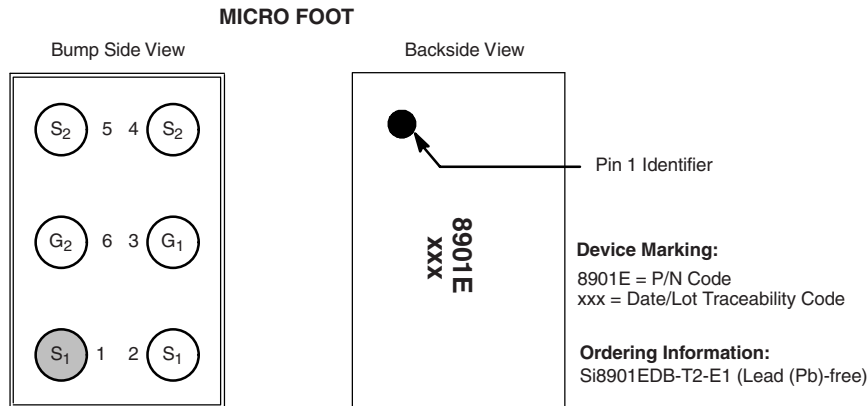

ABSOLUTE MAXIMUM RATINGS $T_A = 25$ °C, unless otherwise noted				
Parameter	Symbol	5 s	Steady State	Unit
Source1- Source2 Voltage	V_{S1S2}	- 20		V
Gate-Source Voltage	V_{GS}	± 12		
Continuous Source1- Source2 Current ($T_J = 150$ °C) ^a	I_{S1S2}	$T_A = 25$ °C	- 4.4	- 3.5
		$T_A = 85$ °C	- 3.2	- 2.5
Pulsed Source1- Source2 Current	I_{SM}	- 10		A
Maximum Power Dissipation ^a	P_D	$T_A = 25$ °C	1.7	1
		$T_A = 85$ °C	0.8	0.5
Operating Junction and Storage Temperature Range	T_J, T_{stg}	- 55 to 150		°C
Package Reflow Conditions ^c	IR/Convection	260		

THERMAL RESISTANCE RATINGS				
Parameter	Symbol	Typical	Maximum	Unit
Maximum Junction-to-Ambient ^a	R_{thJA}	$t \leq 5$ s	60	75
		Steady State	95	120
Maximum Junction-to-Foot ^b	R_{thJF}	18	22	°C/W

Notes:

- Surface Mounted on 1" x 1" FR4 board.
- The foot is defined as the top surface of the package.
- Refer to IPC/JEDEC (J-STD-020C), no manual or hand soldering.



SPECIFICATIONS $T_J = 25\text{ }^\circ\text{C}$, unless otherwise noted						
Parameter	Symbol	Test Conditions	Min.	Typ.	Max.	Unit
Static						
Gate Threshold Voltage	$V_{GS(th)}$	$V_{SS} = V_{GS}, I_D = -350\text{ }\mu\text{A}$	-0.45		-1.0	V
Gate-Body Leakage	I_{GSS}	$V_{SS} = 0\text{ V}, V_{GS} = \pm 4.5\text{ V}$			± 4	μA
		$V_{SS} = 0\text{ V}, V_{GS} = \pm 12\text{ V}$			± 10	mA
Zero Gate Voltage Source Current	I_{S1S2}	$V_{SS} = -20\text{ V}, V_{GS} = 0\text{ V}$			-1	μA
		$V_{SS} = -20\text{ V}, V_{GS} = 0\text{ V}, T_J = 85\text{ }^\circ\text{C}$			-5	
On-State Source Current ^a	$I_{S(on)}$	$V_{SS} = -5\text{ V}, V_{GS} = -4.5\text{ V}$	-5			A
Source1- Source2 On-State Resistance ^a	$R_{S1S2(on)}$	$V_{GS} = -4.5\text{ V}, I_{SS} = -1\text{ A}$		0.048	0.060	Ω
		$V_{GS} = -2.5\text{ V}, I_{SS} = -1\text{ A}$		0.062	0.080	
		$V_{GS} = -1.8\text{ V}, I_{SS} = -1\text{ A}$		0.081	0.105	
Forward Transconductance ^a	g_{fs}	$V_{SS} = -10\text{ V}, I_{SS} = -1\text{ A}$		7		S
Dynamic^b						
Turn-On Delay Time	$t_{d(on)}$	$V_{SS} = -10\text{ V}, R_L = 10\text{ }\Omega$ $I_{SS} = -1\text{ A}, V_{GEN} = -4.5\text{ V}, R_g = 6\text{ }\Omega$		2.3	3.5	μs
Rise Time	t_r			2.2	3.5	
Turn-Off Delay Time	$t_{d(off)}$			1.3	2	
Fall Time	t_f			9	14	

Notes:

- a. Pulse test; pulse width $\leq 300\text{ }\mu\text{s}$, duty cycle $\leq 2\%$.
- b. Guaranteed by design, not subject to production testing.

Stresses beyond those listed under "Absolute Maximum Ratings" may cause permanent damage to the device. These are stress ratings only, and functional operation of the device at these or any other conditions beyond those indicated in the operational sections of the specifications is not implied. Exposure to absolute maximum rating conditions for extended periods may affect device reliability.

TYPICAL CHARACTERISTICS $25\text{ }^\circ\text{C}$, unless otherwise noted

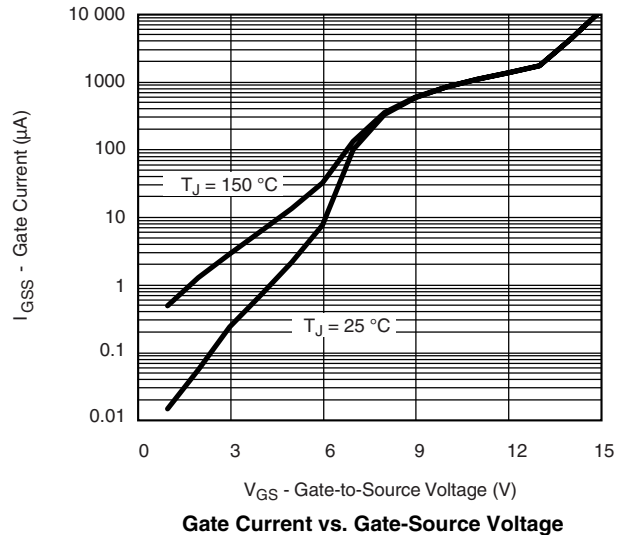
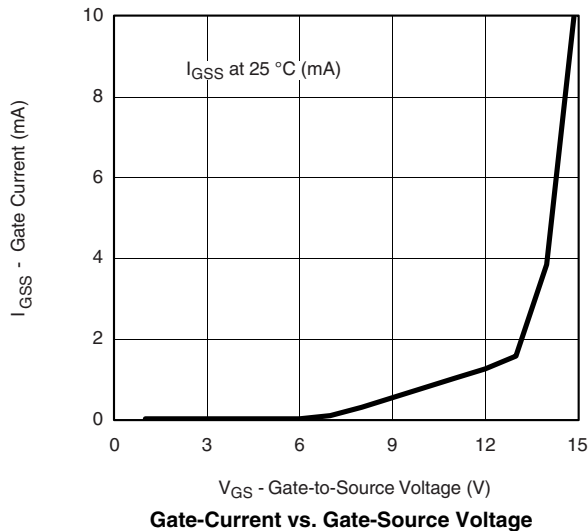

TYPICAL CHARACTERISTICS 25 °C, unless otherwise noted

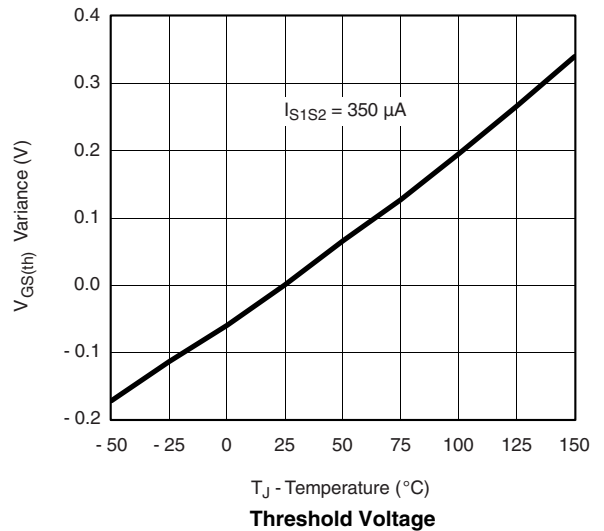
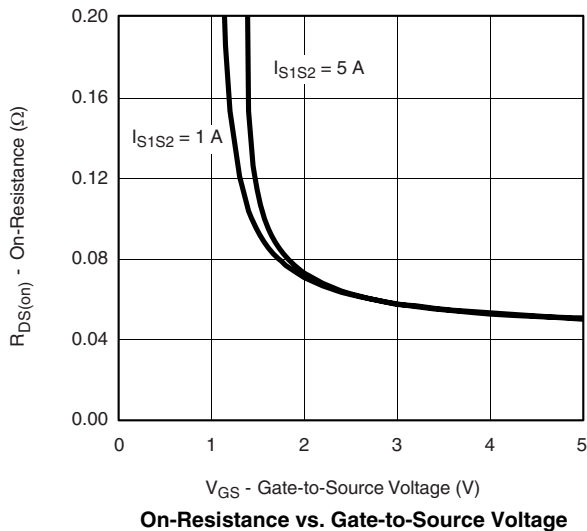
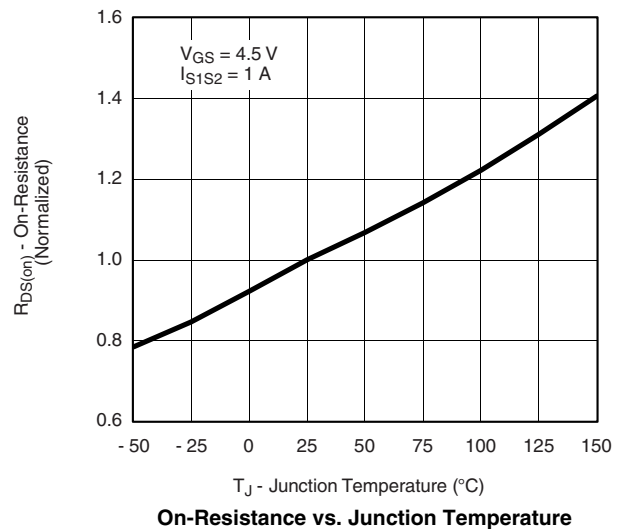
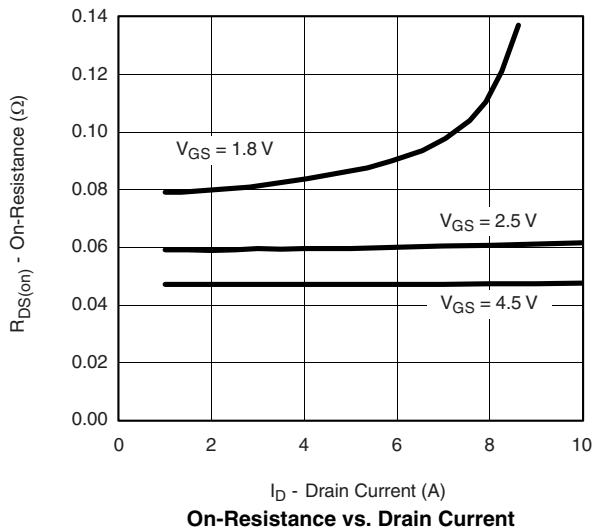
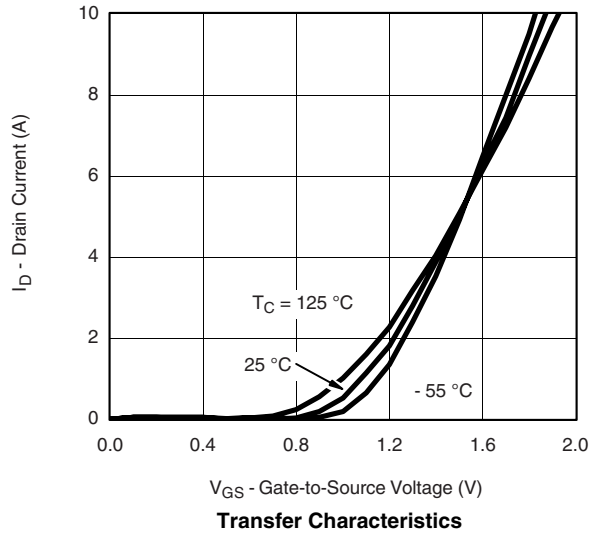
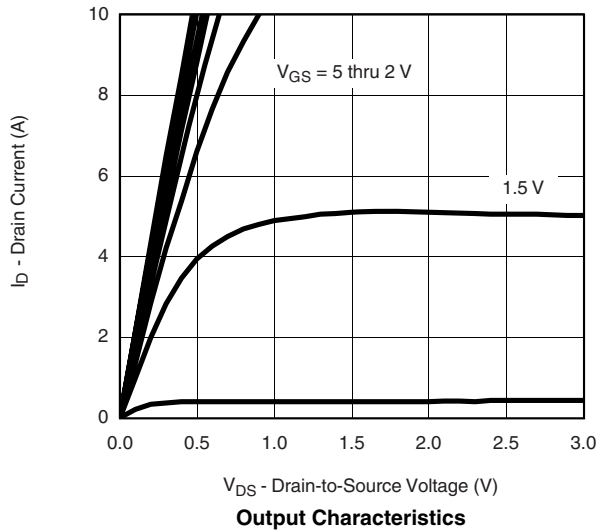

TYPICAL CHARACTERISTICS 25 °C, unless otherwise noted

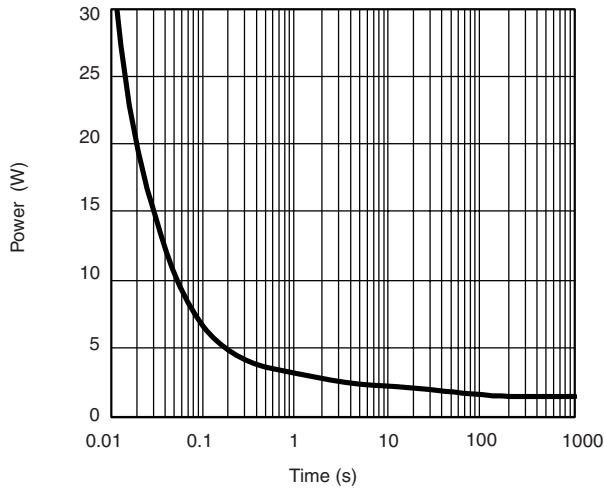

Single Pulse Power, Junction-to-Ambient

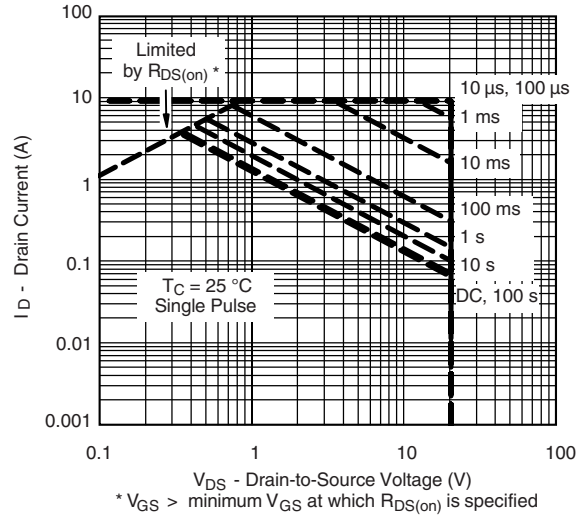

* $V_{GS} >$ minimum V_{GS} at which $R_{DS(on)}$ is specified

Safe Operating Area

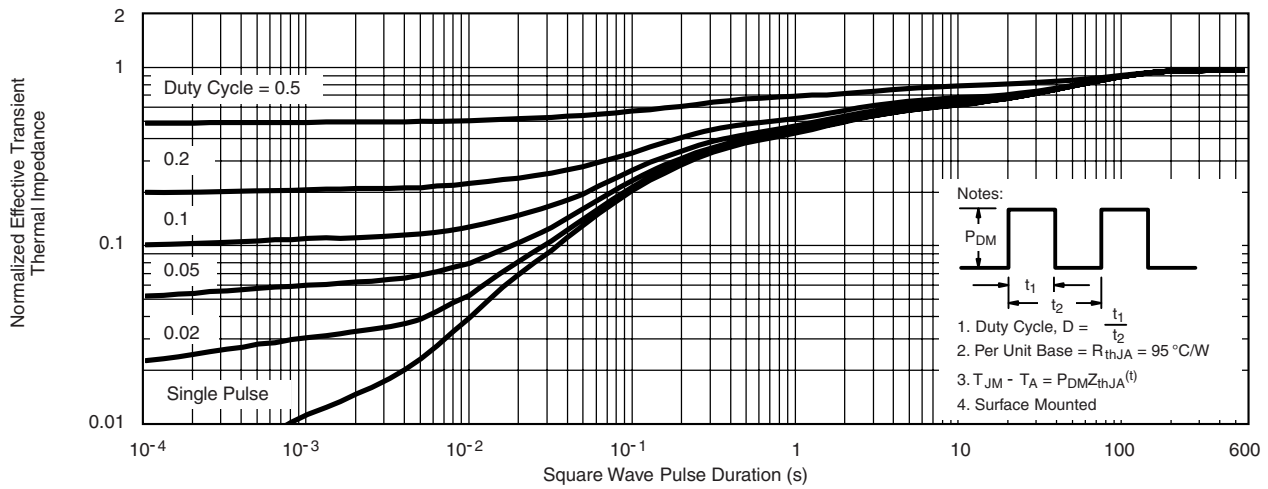

Normalized Thermal Transient Impedance, Junction-to-Ambient

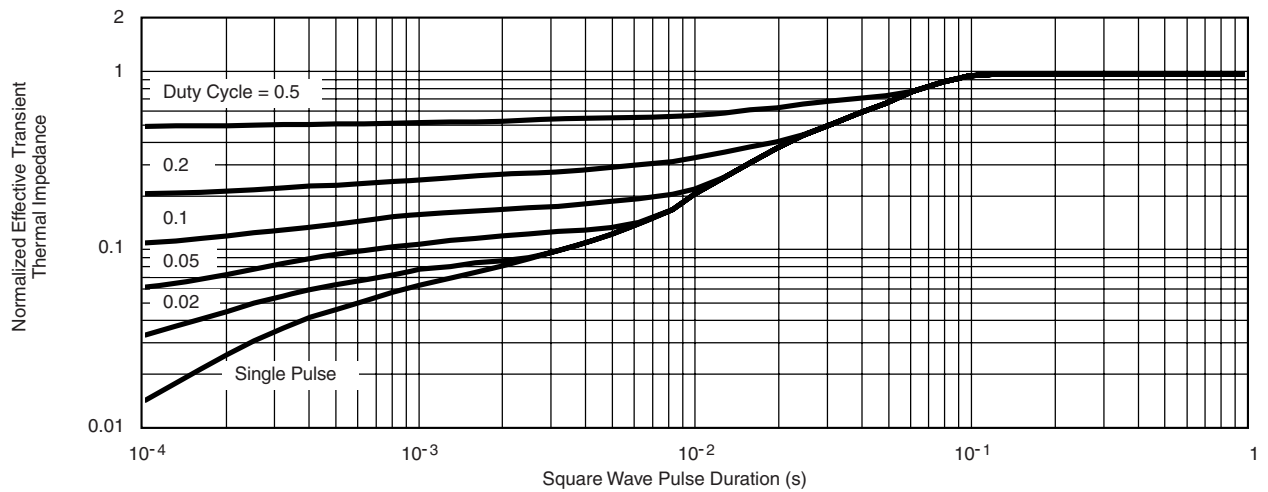

Normalized Thermal Transient Impedance, Junction-to-Foot

PACKAGE OUTLINE

MICRO FOOT: 6-BUMP (2 x 3, 0.8 mm PITCH)

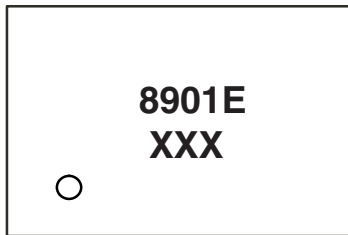
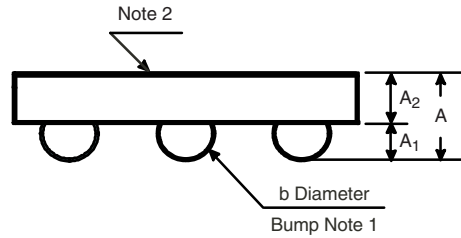
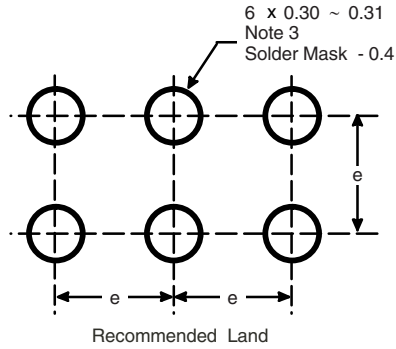

Mark on Backside of Die

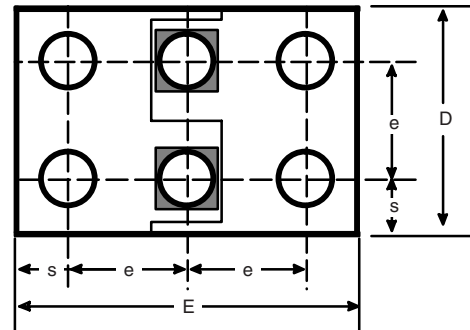

Notes (Unless Otherwise Specified):

1. 6 solder bumps are 95.5/3.8/0.7 Sn/Ag/Cu.
2. Backside surface is coated with a Ag/Ni/Ti layer.
3. Non-solder mask defined copper landing pad.
4. Laser marks on the silicon die back.

Dim.	Millimeters ^a		Inches	
	Min.	Max.	Min.	Max.
A	0.600	0.650	0.0236	0.0256
A₁	0.260	0.290	0.102	0.114
A₂	0.340	0.360	0.0134	0.0142
b	0.370	0.410	0.0146	0.0161
D	1.52	1.6	0.0598	0.0630
E	2.32	2.4	0.0913	0.0945
e	0.750	0.850	0.0295	0.0335
s	0.380	0.400	0.0150	0.0157

Notes:

- a. Use millimeters as the primary measurement.

Vishay Siliconix maintains worldwide manufacturing capability. Products may be manufactured at one of several qualified locations. Reliability data for Silicon Technology and Package Reliability represent a composite of all qualified locations. For related documents such as package/tape drawings, part marking, and reliability data, see <http://www.vishay.com/ppg?72941>.



Disclaimer

ALL PRODUCT, PRODUCT SPECIFICATIONS AND DATA ARE SUBJECT TO CHANGE WITHOUT NOTICE TO IMPROVE RELIABILITY, FUNCTION OR DESIGN OR OTHERWISE.

Vishay Intertechnology, Inc., its affiliates, agents, and employees, and all persons acting on its or their behalf (collectively, "Vishay"), disclaim any and all liability for any errors, inaccuracies or incompleteness contained in any datasheet or in any other disclosure relating to any product.

Vishay makes no warranty, representation or guarantee regarding the suitability of the products for any particular purpose or the continuing production of any product. To the maximum extent permitted by applicable law, Vishay disclaims (i) any and all liability arising out of the application or use of any product, (ii) any and all liability, including without limitation special, consequential or incidental damages, and (iii) any and all implied warranties, including warranties of fitness for particular purpose, non-infringement and merchantability.

Statements regarding the suitability of products for certain types of applications are based on Vishay's knowledge of typical requirements that are often placed on Vishay products in generic applications. Such statements are not binding statements about the suitability of products for a particular application. It is the customer's responsibility to validate that a particular product with the properties described in the product specification is suitable for use in a particular application. Parameters provided in datasheets and/or specifications may vary in different applications and performance may vary over time. All operating parameters, including typical parameters, must be validated for each customer application by the customer's technical experts. Product specifications do not expand or otherwise modify Vishay's terms and conditions of purchase, including but not limited to the warranty expressed therein.

Except as expressly indicated in writing, Vishay products are not designed for use in medical, life-saving, or life-sustaining applications or for any other application in which the failure of the Vishay product could result in personal injury or death. Customers using or selling Vishay products not expressly indicated for use in such applications do so at their own risk and agree to fully indemnify and hold Vishay and its distributors harmless from and against any and all claims, liabilities, expenses and damages arising or resulting in connection with such use or sale, including attorneys fees, even if such claim alleges that Vishay or its distributor was negligent regarding the design or manufacture of the part. Please contact authorized Vishay personnel to obtain written terms and conditions regarding products designed for such applications.

No license, express or implied, by estoppel or otherwise, to any intellectual property rights is granted by this document or by any conduct of Vishay. Product names and markings noted herein may be trademarks of their respective owners.