

P-Channel 30-V (D-S) MOSFET

PRODUCT SUMMARY		
V_{DS} (V)	$r_{DS(on)}$ (Ω)	I_D (A)
-30	0.006 @ $V_{GS} = -10$ V	-24

FEATURES

- TrenchFET® Power MOSFETS
- New Low Thermal Resistance PowerPAK™ Package with Low 1.07-mm Profile

APPLICATIONS

- Battery and Load Switching
 - Notebook Computers
 - Notebook Battery Packs

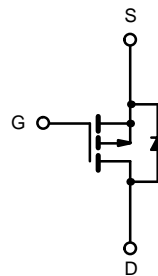
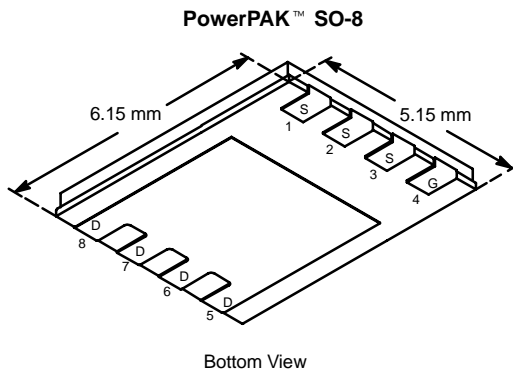

ABSOLUTE MAXIMUM RATINGS ($T_A = 25^\circ\text{C}$ UNLESS OTHERWISE NOTED)					
Parameter	Symbol	10 secs	Steady State	Unit	
Drain-Source Voltage	V_{DS}	-30		V	
Gate-Source Voltage	V_{GS}	± 25			
Continuous Drain Current ($T_J = 150^\circ\text{C}$) ^a	I_D	$T_A = 25^\circ\text{C}$	-24	-14	A
		$T_A = 70^\circ\text{C}$	-19	-11	
Pulsed Drain Current	I_{DM}	-60			
continuous Source Current (Diode Conduction) ^a	I_S	-4.5	-1.6		
Maximum Power Dissipation ^a	P_D	$T_A = 25^\circ\text{C}$	5.4	1.9	W
		$T_A = 70^\circ\text{C}$	3.4	1.2	
Operating Junction and Storage Temperature Range	T_J, T_{stg}	-55 to 150		$^\circ\text{C}$	

THERMAL RESISTANCE RATINGS					
Parameter	Symbol	Typical	Maximum	Unit	
Maximum Junction-to-Ambient ^a	R_{thJA}	$t \leq 10$ sec	18	23	$^\circ\text{C/W}$
		Steady State	50	65	
Maximum Junction-to-Case (Drain)	R_{thJC}	1.0	1.5		

Notes

a. Surface Mounted on 1" x 1" FR4 Board.

SPECIFICATIONS (T_J = 25 °C UNLESS OTHERWISE NOTED)

Parameter	Symbol	Test Condition	Min	Typ	Max	Unit
Static						
Gate Threshold Voltage	V _{GS(th)}	V _{DS} = V _{GS} , I _D = -250 μA	-1.0		-3.0	V
Gate-Body Leakage	I _{GSS}	V _{DS} = 0 V, V _{GS} = ±20 V			±100	nA
		V _{DS} = 0 V, V _{GS} = ±25 V			±200	
Zero Gate Voltage Drain Current	I _{DSS}	V _{DS} = -24 V, V _{GS} = 0 V			-1	μA
		V _{DS} = -24 V, V _{GS} = 0 V, T _J = 70 °C			-10	
On-State Drain Current ^a	I _{D(on)}	V _{DS} = -5 V, V _{GS} = -10 V	-30			A
Drain-Source On-State Resistance ^a	r _{DS(on)}	V _{GS} = -10 V, I _D = -24 A		0.0047	0.006	Ω
Forward Transconductance ^a	g _{fs}	V _{DS} = -15 V, I _D = -24 A		50		S
Diode Forward Voltage ^a	V _{SD}	I _S = -2.9 A, V _{GS} = 0 V		-0.71	-1.1	V
Dynamic^b						
Total Gate Charge	Q _g	V _{DS} = -15 V, V _{GS} = -10 V, I _D = -24 A		113	170	nC
Gate-Source Charge	Q _{gs}		17			
Gate-Drain Charge	Q _{gd}		32.5			
Turn-On Delay Time	t _{d(on)}	V _{DD} = -15 V, R _L = 15 Ω I _D ≅ -1 A, V _{GEN} = -10 V, R _G = 6 Ω		25	40	ns
Rise Time	t _r		20	30		
Turn-Off Delay Time	t _{d(off)}		180	270		
Fall Time	t _f		130	200		
Gate Resistance	R _g			4		Ω
Source-Drain Reverse Recovery Time	t _{rr}	I _F = -2.9 A, di/dt = 100 A/μs		100	150	ns

Notes

- a. Pulse test; pulse width ≤ 300 μs, duty cycle ≤ 2%.
b. Guaranteed by design, not subject to production testing.

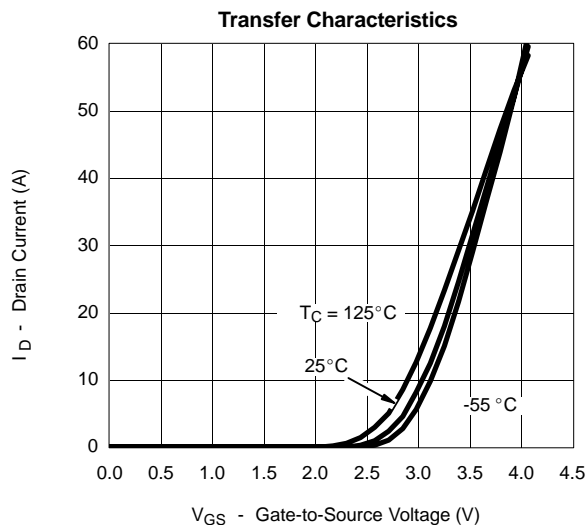
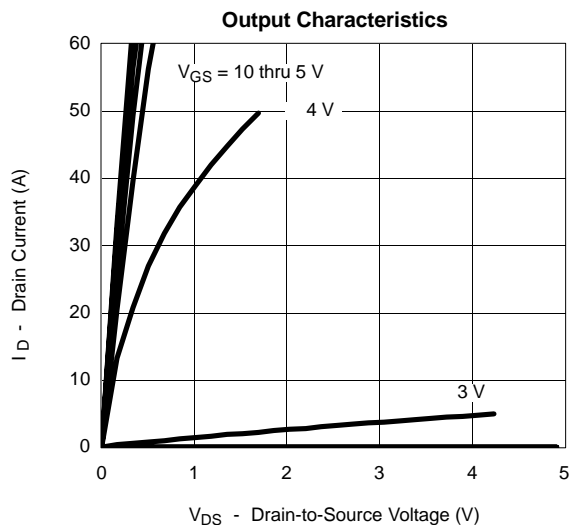
TYPICAL CHARACTERISTICS (25 °C UNLESS NOTED)

TYPICAL CHARACTERISTICS (25 °C UNLESS NOTED)

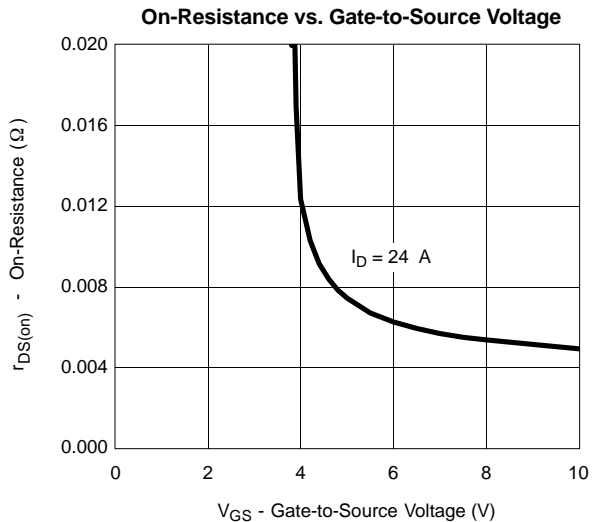
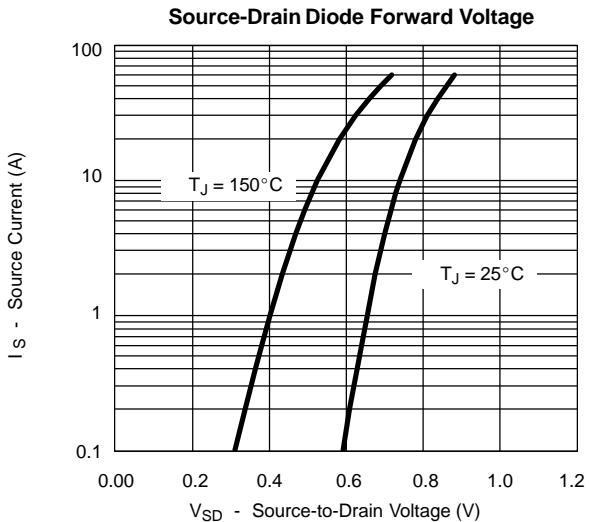
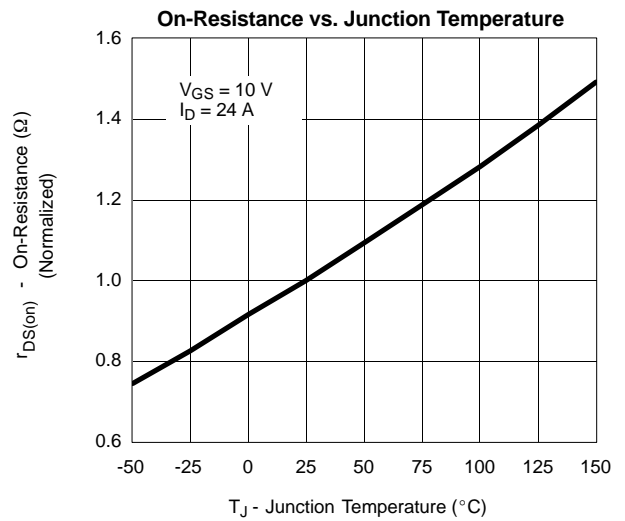
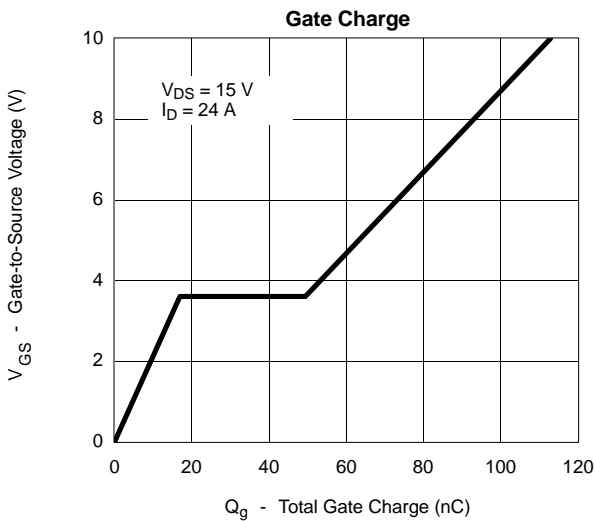
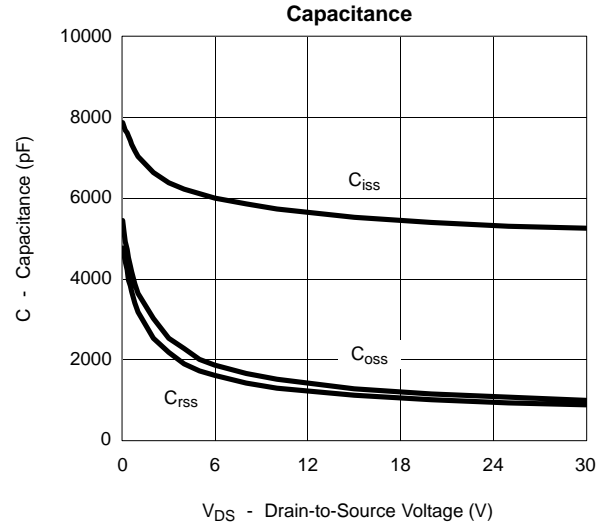
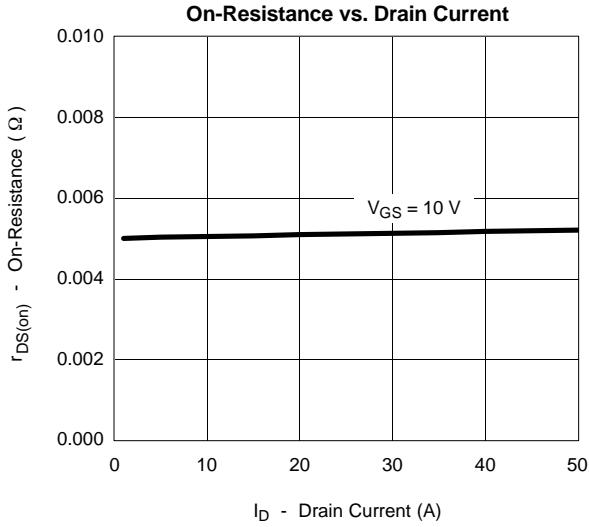

TYPICAL CHARACTERISTICS (25 °C UNLESS NOTED)

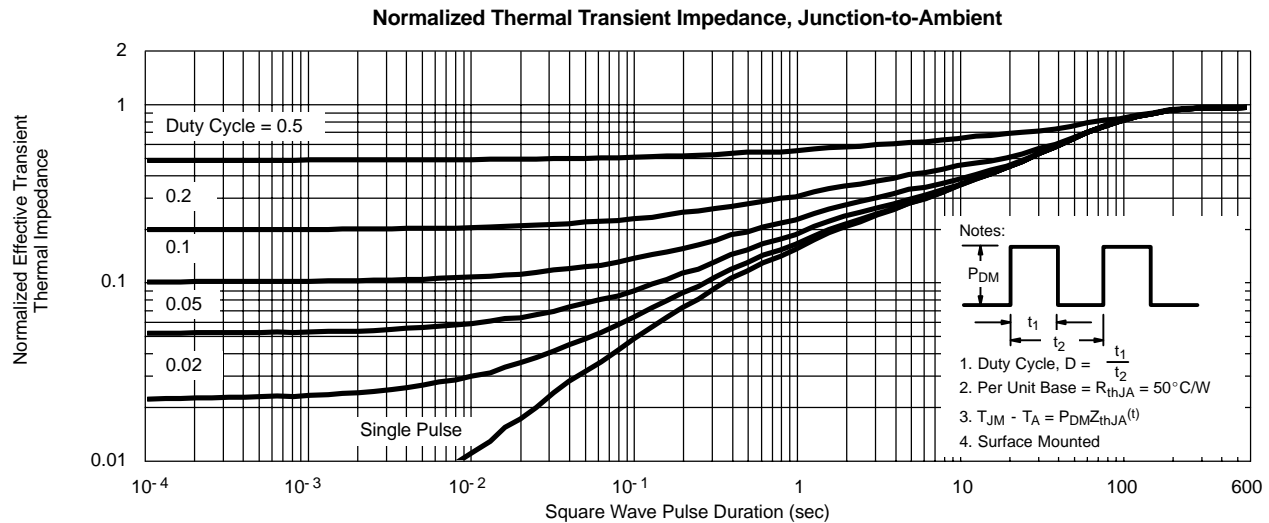
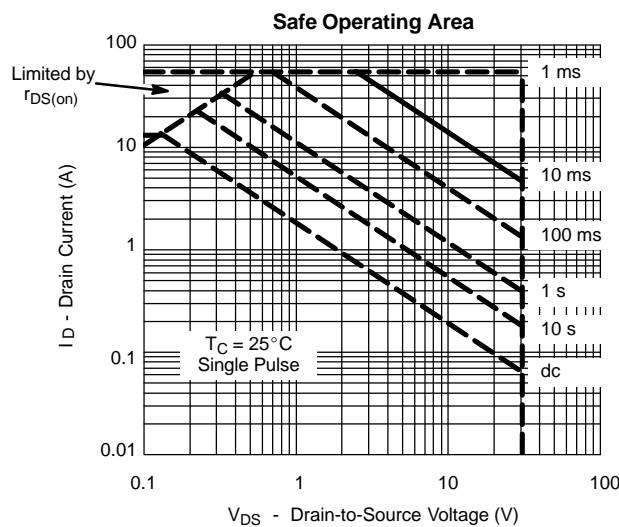
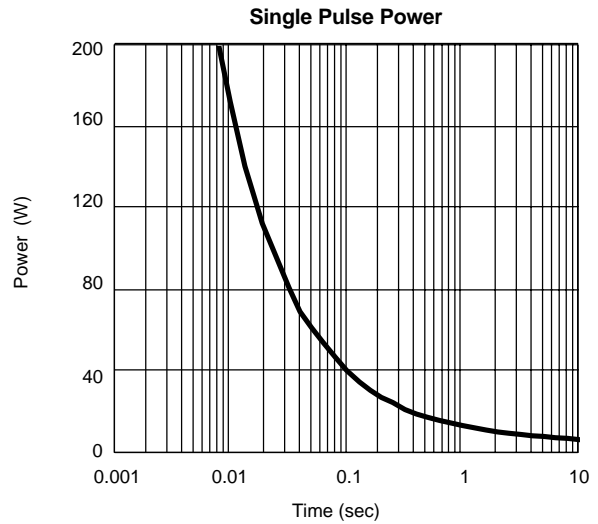
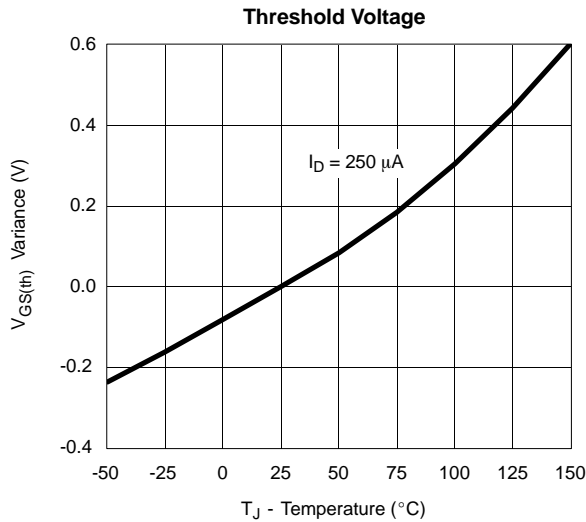



TYPICAL CHARACTERISTICS (25 °C UNLESS NOTED)

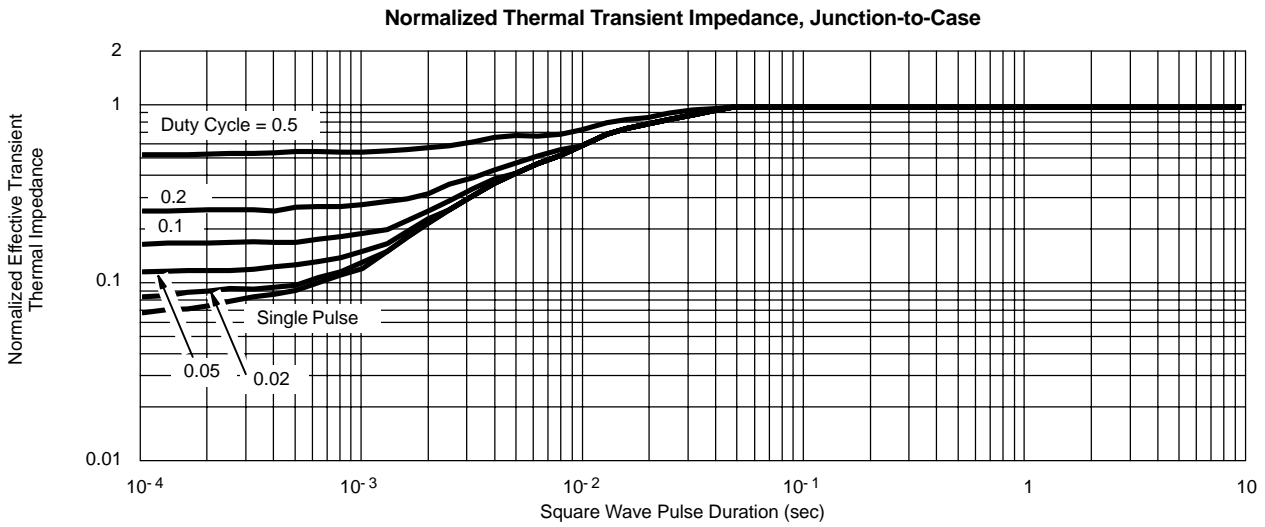



Disclaimer

All product specifications and data are subject to change without notice.

Vishay Intertechnology, Inc., its affiliates, agents, and employees, and all persons acting on its or their behalf (collectively, "Vishay"), disclaim any and all liability for any errors, inaccuracies or incompleteness contained herein or in any other disclosure relating to any product.

Vishay disclaims any and all liability arising out of the use or application of any product described herein or of any information provided herein to the maximum extent permitted by law. The product specifications do not expand or otherwise modify Vishay's terms and conditions of purchase, including but not limited to the warranty expressed therein, which apply to these products.

No license, express or implied, by estoppel or otherwise, to any intellectual property rights is granted by this document or by any conduct of Vishay.

The products shown herein are not designed for use in medical, life-saving, or life-sustaining applications unless otherwise expressly indicated. Customers using or selling Vishay products not expressly indicated for use in such applications do so entirely at their own risk and agree to fully indemnify Vishay for any damages arising or resulting from such use or sale. Please contact authorized Vishay personnel to obtain written terms and conditions regarding products designed for such applications.

Product names and markings noted herein may be trademarks of their respective owners.