

FEATURES

- Low cost! High reliability!
- 1" x 1" through-hole package or 1.01" x 1.01" SMT package
- Gull-wing leads; Standard reflow
- Complete; No external components
- Outputs: 1.8V/2A, 2.5V/2A, 3.3V/3A
- Inputs: 4.75-5.5V, 10.8-13.6V
- Guaranteed efficiencies to 87%
- Output noise as low as 40mVp-p
- Transient response as quick as 20μsec
- -40 to +70°C operation with no derating
- On/off control; EMC compliant
- IEC950/EN60950/UL1950 approvals
- Modifications and customs for OEM's

PRODUCT OVERVIEW

Murata Power Solutions' 3.6-10W UNR Series consists of non-isolated, 5V-to-1.8V (2A), 5V-to-2.5V (2A), 5V-to-3.3V (3A), and 12V-to-3.3V (3A) DC/DC converters in miniature surface-mount and through-hole packages. The "gull-wing" SMT packages (with metal shells and non-conductive plastic baseplates) weigh a mere 17 grams and can withstand lead temperatures up to +230°C. They are compatible with virtually all contemporary pick-and-place and solder-reflow processes.

The true benefits of distributed power will ultimately be realized only when every low-voltage, high-current CPLD, ASIC, DSP, etc. has its own "power plant" right next to it. With isolated DC/DC converters inevitably residing at the edges of boards in proximity with backplanes and power buses, the "on-board" proliferation of distributed power will continue with more cost-effective, non-isolated devices. The low-cost, easy-to-use (no external components required), highly reliable (100% fully automated SMT construction) 3.6-10W

UNR Series makes this power processing at the concluding point of use a practical reality today.

These versatile DC/DC's are fully line and load regulated. They feature user-optional on/off control (for power-sequencing requirements), output current limiting, and short-circuit protection (foldback technique with auto-recovery). Additionally, the 12V-to-3.3V models offer input undervoltage lockout (at 9.6V). Their impressive guaranteed efficiencies enable all models to deliver their fully rated output power from -40 to +65/70°C (ambient) without heat sinking or forced-air cooling.

If you've already considered and rejected the use of inefficient, step-down, linear regulators, take a look at one of these new switching buck regulators. Their high efficiency, ease-of-use, long-term reliability, and overall cost effectiveness will impress you. Safety agency approvals are currently in progress.

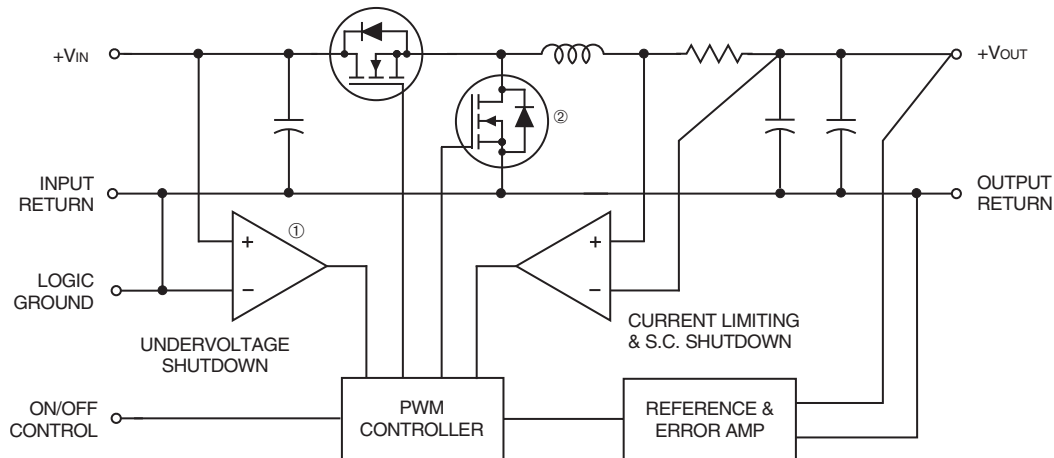

Figure 1. Simplified Schematic Typical topology is shown.

- ① "D5" models do not have input undervoltage shutdown.
- ② "D5" models employ a more traditional buck-regulator design in which this FET is replaced with a power Schottky diode.



PERFORMANCE SPECIFICATIONS AND ORDERING GUIDE													
Part Number ^⑥	Output							Input			Efficiency		Package (Case Pinout)
	V _{out} (V)	I _{out} (A)	Power (W)	R/N (mVp-p) ^②		Regulation (Max.)		V _{in} Nom. (V)	Range (V)	I _{in} ^④ (mA/A)	Min.	Typ.	
				Typ.	Max.	Line	Load ^③						
UNR-1.8/2-D5	1.8	2	3.6	35	50	±0.35%	±0.5%	5	4.75-5.5	30/0.91	77%	79%	C7A, P9
UNR-1.8/2-D5SM	1.8	2	3.6	35	50	±0.35%	±0.5%	5	4.75-5.5	30/0.91	77%	79%	C17, P24
UNR-2.5/2-D5	2.5	2	5	40	80	±0.1%	±0.5%	5	4.75-5.5	200/5.62	85%	89%	C7A, P9
UNR-2.5/2-D5SM	2.5	2	5	40	80	±0.1%	±0.5%	5	4.75-5.5	200/5.62	85%	89%	C17, P24
UNR-3.3/3-D5	3.3	3	9.9	40	75	±0.4%	±0.5%	5	4.75-5.5	40/2.25	86%	88%	C7A, P9
UNR-3.3/3-D5SM	3.3	3	9.9	40	75	±0.4%	±0.5%	5	4.75-5.5	40/2.25	86%	88%	C17, P24
UNR-3.3/3-D12 ^②	3.3	3	9.9	100	150	±0.25%	±0.5%	12	10.8-13.6	40/0.93	87%	89%	C7A, P9
UNR-3.3/3-D12SM ^②	3.3	3	9.9	100	150	±0.25%	±0.5%	12	10.8-13.6	40/0.93	87%	89%	C17, P24

① Typical at T_A = +25°C under nominal line voltage and full-load conditions, unless otherwise noted. The UNR-1.8/2-D5 and D5SM models require an external 15kΩ pull-up resistor between +Input and On/Off Control for normal operation. See On/Off Control for details.

② Ripple/Noise (R/N) measured over a 20MHz bandwidth. The UNR-3.3/3-D12 and D12SM models are specified with an external 22µF input capacitor. All other models are specified with no external I/O capacitors. Output noise on the D12 models can be reduced significantly with the addition of external output capacitors. See I/O Filtering.

③ D5/D5SM models require a minimum 300mA load current to maintain regulation. D12/D12SM models have no minimum load requirement. Listed specs apply from 300mA to full load for D5/D5SM models and from no load to full load for D12/D12SM models.

④ Nominal line voltage, no-load/full-load conditions.

⑤ D5/D5SM models may experience start-up problems if voltages greater than 1.0V (for 3.3V models) or 1.2V (for 1.8/2.5V models) are present across the output pins during power-up.

⑥ These are only partial part numbers. Refer to the part number structure when ordering.

PART NUMBER STRUCTURE

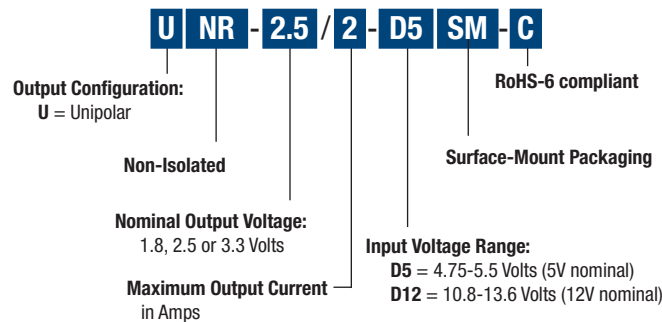

MECHANICAL SPECIFICATIONS

THROUGH-HOLE MOUNT

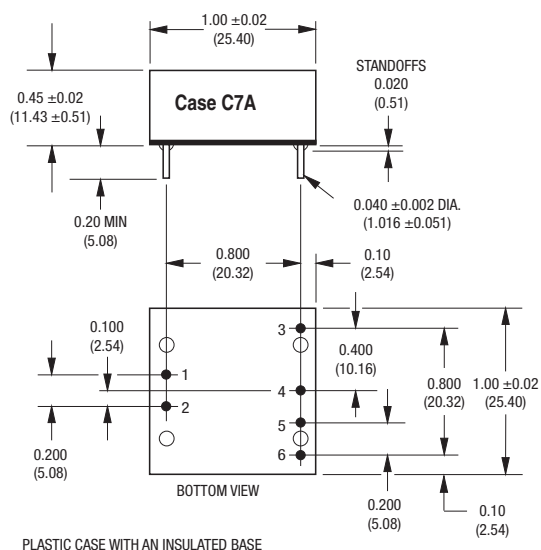

SURFACE MOUNT

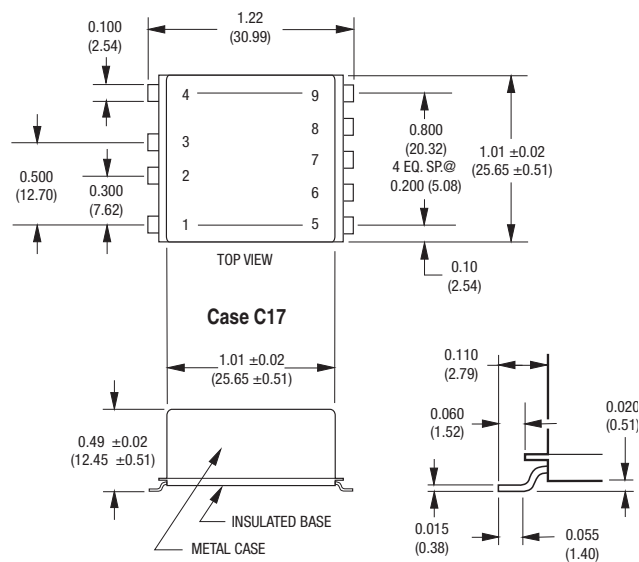

SEE SPECIAL SMT SOLDER INSTRUCTIONS ON PAGE 6

Dimensions are in inches (mm shown for ref. only).

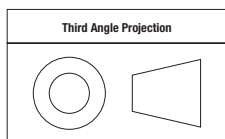

Tolerances (unless otherwise specified):
 .XX ± 0.02 (0.5)
 .XXX ± 0.010 (0.25)
 Angles ± 2°

Components are shown for reference only.

INPUT/OUTPUT CONNECTIONS

Pin	Function P9	Function P24
1	Logic Ground	N.C.
2	On/Off Control	Logic Ground
3	+Output	On/Off Control
4	Output Return	N.C.
5	Input Return	+Output
6	+Input	N.C.
7	No Pin	Output Return
8	No Pin	Input Return
9	No Pin	+Input

Performance/Functional Specifications

Typical @ T_A = +25°C under nominal line voltage and full-load conditions with no external filtering.
Specifications apply to both surface-mount and through-hole models, unless noted. ① ⑦

Input	
Input Voltage Range:	
D5 Models	4.75-5.5 Volts (5V nominal)
D12 Models	10.8-13.6 Volts (12V nominal)
Overvoltage Shutdown	None
Start-Up Threshold:	
D12 Models ②	10.2V typical, 10.8V maximum
Undervoltage Shutdown:	
D12 Models ②	9.6V typical, 8.2V minimum
Input Current:	
Normal Operating Conditions	See Ordering Guide
Standby Mode (Off or undervoltage):	
1.8V _{OUT}	20mA typical, 30mA maximum
2.5V _{OUT} , 3.3V _{OUT} D5 Models	11mA typical, 20mA maximum
3.3V _{OUT} D12 Models	5mA typical, 10mA maximum
Output Short-Circuit Condition	50mA _{Arms}
Input Ripple Current:	
1.8V _{OUT} , 3.3V _{OUT} D12 Models	50mA _{p-p}
2.5V _{OUT} , 3.3V _{OUT} D5 Models	150mA _{p-p}
Input Filter Type	Capacitive
Reverse-Polarity Protection	None, install external fuse
On/Off Control ③	TTL high (or open) = on, low = off 1.5V typical logic threshold
Output	
V_{OUT} Accuracy (50% load):	
1.8V _{OUT} Models	±1.75% (±32mV) maximum
2.5V _{OUT} Models	±1.75% (±44mV) maximum
3.3V _{OUT} D5 Models	±1.5% (±50mV) maximum
3.3V _{OUT} D12 Models	±1% (±33mV) maximum
Temperature Coefficient	±0.02% per °C
Ripple/Noise (20MHz BW) ④	See Ordering Guide
Line/Load Regulation	See Ordering Guide
Efficiency	See Ordering Guide
Current Limiting ⑤	Auto-recovery
Dynamic Characteristics	
Transient Response (50% load step):	
1.8V _{OUT} Models	20µsec to ±1% of final value
2.5V _{OUT} , 3.3V _{OUT} D12 Models	30µsec to ±1% of final value
3.3V _{OUT} D5 Models	40µsec to ±1% of final value
Start-Up Time: ⑥ ⑦	
V _{IN} to V _{OUT} : D5 Models	100msec typical, 120msec maximum
D12 Models	13msec typical, 20msec maximum
On/Off to V _{OUT} : D5 Models	60msec typical, 120msec maximum
D12 Models	13msec typical, 20msec maximum
Switching Frequency	200kHz (±30kHz)
Environmental	
Operating Temperature (Ambient):	
Without Derating	-40 to +65/70°C
With Derating	to +100°C (See Derating Curves)
Storage Temperature	-40 to +105°C
Flammability	UL 94V-0

Physical	
Dimensions:	
Surface Mount Package	1.01"x1.01"x0.49" (25.65x25.65x12.45mm) nom.
Through Hole Package	1.00"x1.00"x0.45" (25.40x25.40x11.43mm) nom.
Shielding:	
Surface Mount Package	5-sided
Through Hole Package	None
Case Connection (Surface Mount)	Input/output return
Case Material:	
Surface Mount Package	Corrosion-resistant steel with non-conductive, epoxy-based, black enamel finish and plastic baseplate
Through Hole Package	Diallyl phthalate, UL94V-0 rated
Pin Material:	
RoHS:	Gold plate over copper alloy
Non-RoHS	Tin over copper alloy
Weight	0.6 ounces (17 grams)

- ① D5 models require a minimum 300mA load current to maintain specified regulation. D12 models have no minimum load requirement. Operating D5 models under no-load conditions will not damage these devices, however they may not meet all listed specifications. The UNR-1.8/2.5 and D5SM require an external 15Ω pull-up resistor between +Input and On/Off Control for normal operation. See On/Off Control for details. The UNR-3.3/3-D12 and D12SM are specified with an external 22µF input capacitor. See I/O Filtering for details.
- ② See Startup Threshold and Undervoltage Shutdown for details.
- ③ See On/Off Control for details.
- ④ The 22µF external input capacitor required for the UNR-3.3/3-D12 and D12SM should be minimally rated for 1.5A_{Arms} ripple current and 125mΩ ESR. Output noise for all models can be further reduced with the installation of external output capacitors. See I/O Filtering for details.
- ⑤ Current limiting initiates at approximately 30% above rated load. Under short-circuit conditions, output current folds back to approximately 150mA and input current drops to approximately 50mA. Both remain at those levels until the short is removed.
- ⑥ See Start-Up Time for details.
- ⑦ D5/D5SM models may experience start-up problems if voltages greater than 1.0V (for 3.3V models) or 1.2V (for 1.8/2.5V models) are present across the output pins during power-up.

Absolute Maximum Ratings	
Input Voltage:	
Continuous:	
D5 Models	7 Volts
D12 Models	15 Volts
Transient (100msec):	
D5 Models	15 Volts
D12 Models	24 Volts
Input Reverse-Polarity Protection	None, install external fuse
Output Overvoltage Protection	None
Output Current	Current limited. Devices can withstand a sustained output short circuit without damage.
Storage Temperature	-40 to +105°C
Lead Temperature	
Selective soldering (10 sec.)	+300°C
Reflow soldering (75 sec.)	+230°C
These are stress ratings. Exposure of devices to greater than any of these conditions may adversely affect long-term reliability. Proper operation under conditions other than those listed in the Performance/Functional Specifications Table is not implied.	

TEMPERATURE DERATING

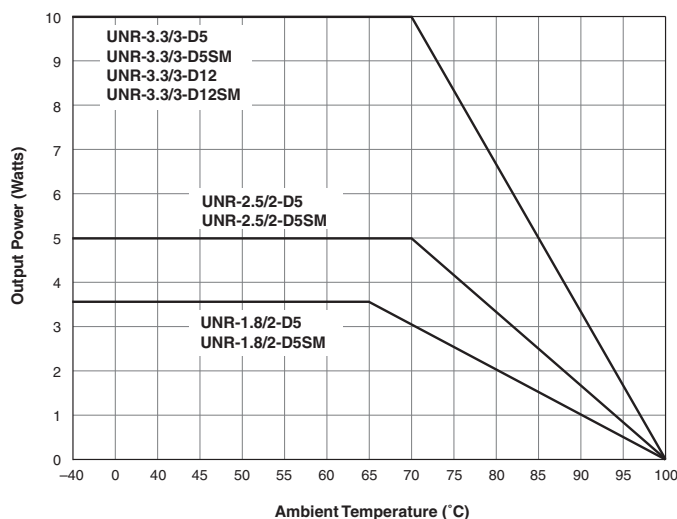

TECHNICAL NOTES

I/O Filtering and Noise Reduction

All D5 models of UNR 3.6-10W Series DC/DC converters achieve their rated ripple and noise specifications without the use of external input/output capacitors. The UNR-3.3/3-D12 and D12SM models are tested and specified with a single, external 22µF input capacitor (minimally rated for 1.5Arms ripple current and 120mΩ ESR).

In critical applications, input/output ripple/noise may be further reduced by installing additional external I/O caps. Input capacitors, which function primarily as energy-storage elements, should be selected for bulk capacitance, low ESR and high rms-ripple-current ratings. Output capacitors, which function more as true filter elements, should be selected for bulk capacitance, low ESR, and appropriate frequency response. All caps should have appropriate voltage ratings and be mounted as close to the converters as possible. Temperature variations for all parameters should obviously be taken into consideration.

The most effective combination of external I/O capacitors will be a function of your line voltage and source impedance, as well as your particular load and layout conditions. Our Applications Engineers will be happy to recommend potential solutions and can discuss the possibility of our modifying a given device's internal filtering to meet your specific requirements. Contact our Applications Engineering Group for additional details.

Return Current Paths

The Input Return, Output Return and Logic Ground are all connected to each other internal to each device. To the extent possible, all load current should be returned through the Output Return (via low-impedance runs) and all input current returned through the Input Return. Any control signals applied to the On/Off Control pin should be referenced to Logic Ground. The internal trace leading to Logic Ground is not designed to carry high current. Devices should never be installed in a manner that results in high current flow through Logic Ground (i.e., the Input/Output Returns should never be left open or attached via high-impedance connections).

Input Fusing

Certain applications and/or safety agencies may require the installation of fuses at the inputs of power conversion components. Fuses should also be used if the possibility of sustained, non-current-limited, input-voltage polarity reversals exists. For Murata Power Solutions UNR Series 3.6-10 Watt DC/DC Converters, you should use slow-blow type fuses with values no greater than the following.

Model Number	Fuse Value
UNR-1.8/2-D5/-D5SM	1.5 Amps
UNR-2.5/2-D5/-D5SM	2 Amps
UNR-3.3/3-D5/-D5SM	3 Amps
UNR-3.3/3-D12/-D12SM	1.5 Amps

Start-Up Threshold and Undervoltage Shutdown
(UNR-3.3/3-D12 and D12SM only)

Under normal start-up conditions, UNR-3.3/3-D12 and D12SM devices will not begin to regulate until the ramping input voltage exceeds the Start-Up Threshold Voltage (typically 10.2V). Once operating, devices will not turn off until the input voltage drops below the Undervoltage Shutdown/Lockout limit (typically 9.6V). Subsequent re-start will not occur until the input is brought back up to the Start-Up Threshold. This built-in hysteresis obviously avoids any indeterminate on/off conditions at a single voltage.

Start-Up Time

For the three D5 models (that do not have an input turn-on threshold), the V_{IN} to V_{OUT} Start-Up Time is the interval between the time a step input is applied to the device and the fully loaded output voltage enters and remains within its specified accuracy band.

For the UNR-3.3/3-D12 and D12SM, V_{IN} to V_{OUT} Start-Up Time is the interval between the time at which a rapidly ramping input voltage crosses the turn-on threshold point and the fully loaded output voltage enters and remains within its specified accuracy band. Actual measured times will vary with input source impedance, external input capacitance, and the slew rate and final value of the input voltage as it appears to the converter.

The On/Off to V_{OUT} Start-Up Time assumes the converter is turned off via the On/Off Control with the nominal input voltage already applied to the converter. The specification defines the interval between the time at which the converter is turned on and the fully loaded output voltage enters and remains within its specified accuracy band.

Internal circuit design of the 3.3V_{OUT} models mandates that no voltages greater than 1.0V be present on the output pins at power-up. 1.8V_{OUT} and 2.5V_{OUT} models can not have voltages greater than 1.2V present on their output pins at power-up. Failure to comply may result in start-up problems.

On/Off Control

The On/Off Control pin may be used for remote on/off operation. UNR 3.6-10W Series converters are designed so that they are enabled when the control pin is pulled high or left open (normal mode) and disabled when the control pin is pulled low (to less than +0.8V relative to Logic Ground). As shown in the figure and table below, each device has an internal pull-up resistor on its On/Off Control pin whose value and voltage vary with model.

Dynamic control of the on/off function is best accomplished with a mechanical relay or an open-collector/open-drain drive circuit (optically isolated if appropriate). The drive circuit should obviously be able to sink appropriate current when activated and withstand appropriate voltage when deactivated.

Applying an external voltage to the On/Off Control when no input power is applied to the converter can cause permanent damage to the converter. The on/off control function, however, is designed such that the converter can be disabled (pin 2/3 pulled low) while input power is ramping up and then "released" once the input has stabilized. The time duration between the point at which the converter is released and its fully loaded output voltage settles to within specified accuracy can be found in the Performance/Functional Specifications Table.

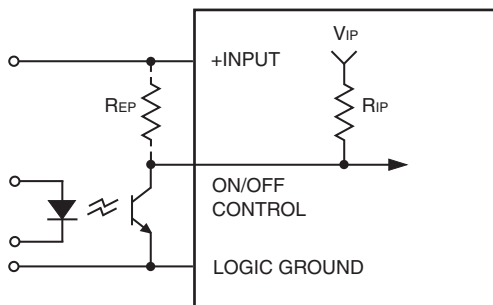

Figure 2. Driving the On/Off Control Pin

Model	Internal Pull-Up Resistor (R _{IP})	External Pull-Up Resistor (R _{EP})	Internal Pull-Up Voltage (V _{IP})
UNR-1.8/2-D5/-D5SM	1kΩ	15kΩ	1.8V
UNR-2.5/2-D5/-D5SM	1kΩ	N.A.	2.5V
UNR-3.3/3-D5/-D5SM	1kΩ	N.A.	3.3V
UNR-3.3/3-D12/-D12SM	10kΩ	N.A.	V _{IN}

SMT Solder Process for SM models

CAUTION — Avoid Reflow Ovens

For the surface-mount "SM" models of the UNR Series, the packages' gull-wing leads are made of tin-plated (150 microinches) copper. The gull-wing configuration, as opposed to "J" leads, was selected to keep the solder joints out from under the package to minimize both, heat conduction away from the leads (into the encapsulated package) and shadowing effects.

"SM" modules do not currently withstand the standard solder-reflow process with its most common temperature profiles. In order to avoid damage to the converter a selective solder process (i.e. hot air gun or a hand soldering method) with the following parameters must therefore be chosen :

Pre-heat phase 30-60°C rise/minute to 150°C maximum.

Lead temperature 300°C for 10 seconds maximum.

As shown in Figure 3, our tests have determined the optimal landing-pad size to be 160 mils by 130 mils (4 x 3.3 mm).

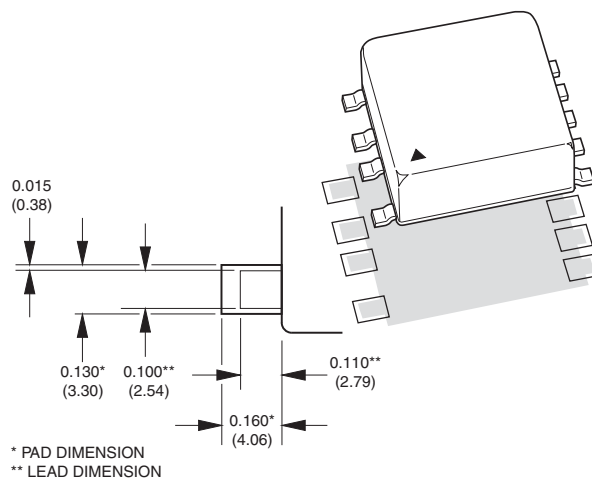

Figure 3. PC Board Land Pattern

TYPICAL PERFORMANCE CURVES

Efficiency vs. Output Current and Input Voltage

UNR-1.8/2-D5/-D5SM

(Guaranteed efficiency = 77% at $V_{IN} = 5V$ and $I_{OUT} = 2A$)

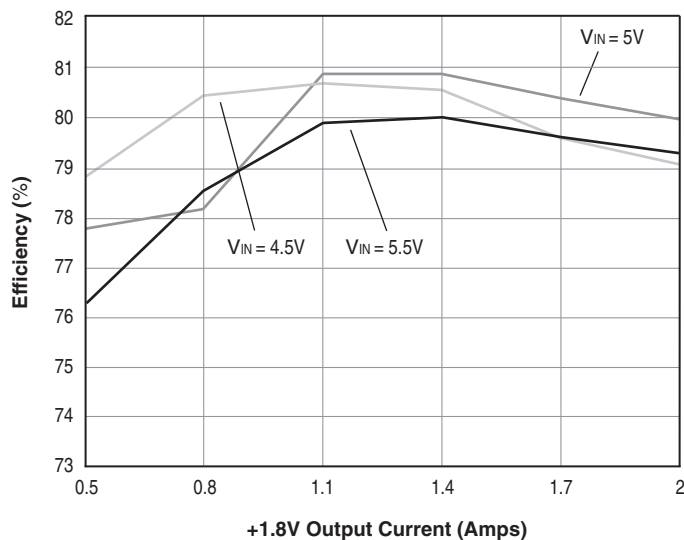

UNR-3.3/3-D5/-D5SM

(Guaranteed efficiency = 86% at $V_{IN} = 5V$ and $I_{OUT} = 3A$)

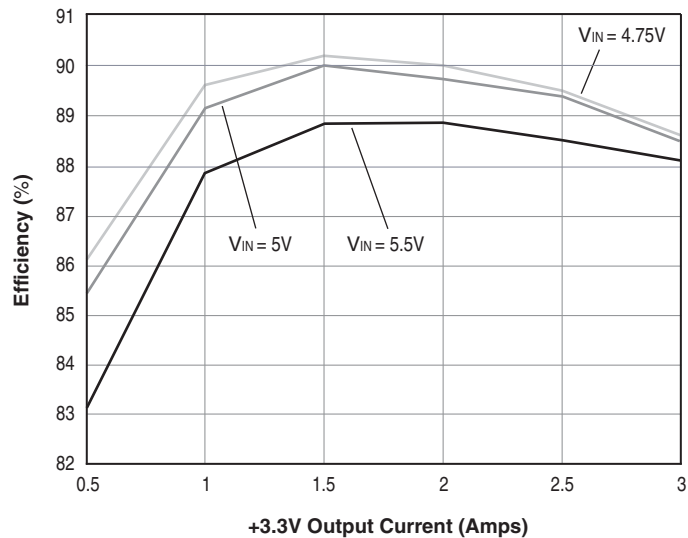

UNR-2.5/2-D5/-D5SM

(Guaranteed efficiency = 83% at $V_{IN} = 5V$ and $I_{OUT} = 2A$)

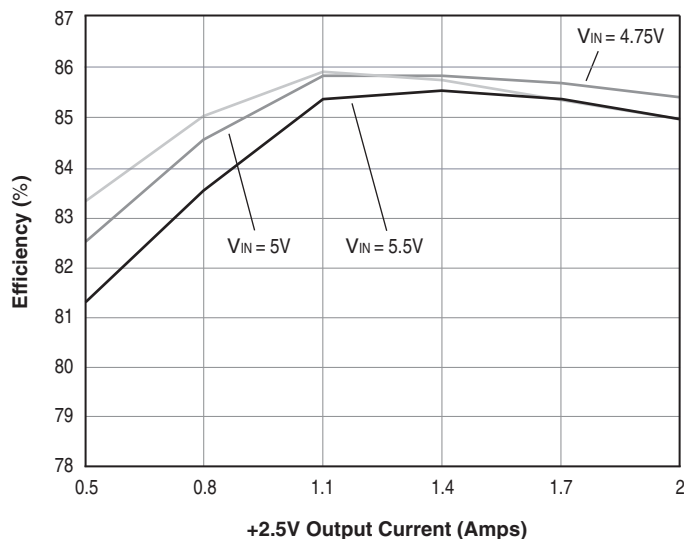

UNR-3.3/3-D12/-D12SM

(Guaranteed efficiency = 87% at $V_{IN} = 12V$ and $I_{OUT} = 3A$)

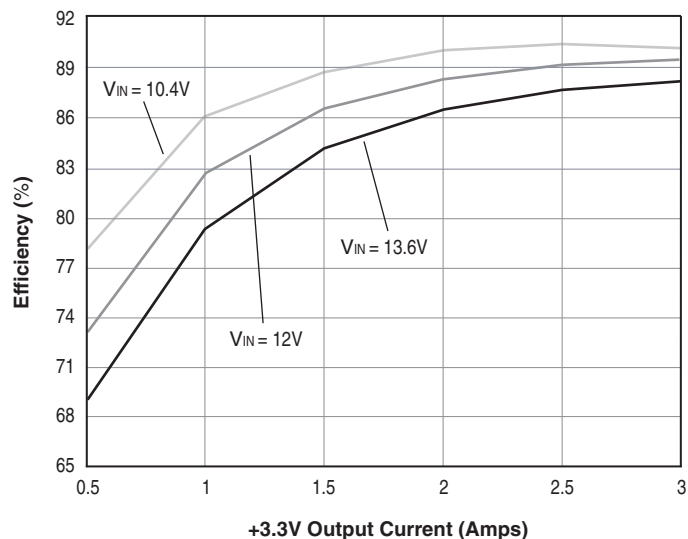

CUSTOM CAPABILITIES

Murata Power Solutions' world-class design, development and manufacturing team stands ready to work with you to deliver the exact power converter you need for your demanding, large volume, OEM applications. And ... we'll do it on time and within budget!

Our experienced applications and design staffs; quick-turn prototype capability; highly automated, SMT assembly facilities; and in-line SPC quality-control techniques combine to give us the unique ability to design and deliver any quantity of power converters to the highest standards of quality and reliability.

We have compiled a large library of DC/DC designs that are currently used in a variety of telecom, medical, computer, railway, aerospace and industrial applications. We may already have the converter you need.

Contact us. Our goal is to provide you the highest-quality, most cost-effective power converters available.

EMI Radiated Emissions

If you're designing with EMC in mind, please note that all of Murata Power Solutions' 3.6-10 Watt UNR Series DC/DC Converters have been characterized for radiated and conducted emissions in our new EMI/EMC laboratory. Testing is conducted in an EMC0 5305 GTEM test cell utilizing EMC0 automated EMC test software. Radiated emissions are tested to the limits of FCC Part 15, Class B and CISPR 22 (EN 55022), Class B. Correlation to other specifications can be supplied upon request. Radiated emissions plots to FCC and CISPR 22 for model UNR-3.3/3-D5SM appear below. Published EMC test reports are available for each model number. Contact Murata Power Solutions' Applications Engineering Department for more details.

**UNR-3.3/3-D5SM Radiated Emissions
FCC Part 15 Class B, 3 Meters
Converter Output = 3.3Vdc @ 2.7 Amps**

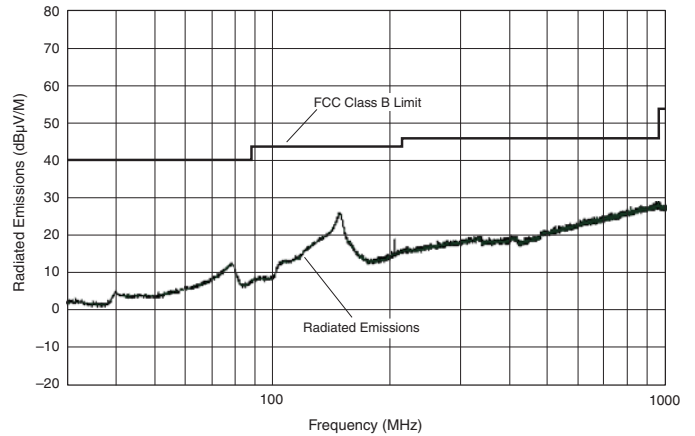

**UNR-3.3/3-D5SM Radiated Emissions
EN 55022 Class B, 10 Meters
Converter Output = 3.3Vdc @ 2.7 Amps**

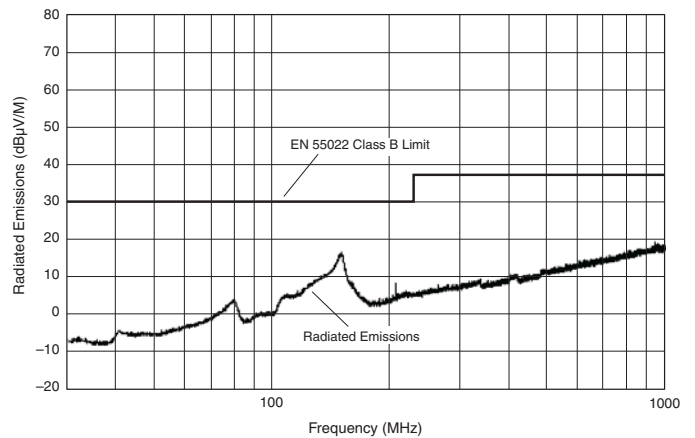

Murata Power Solutions, Inc.
11 Cabot Boulevard, Mansfield, MA 02048-1151 U.S.A.
ISO 9001 and 14001 REGISTERED

Murata Power Solutions, Inc. makes no representation that the use of its products in the circuits described herein, or the use of other technical information contained herein, will not infringe upon existing or future patent rights. The descriptions contained herein do not imply the granting of licenses to make, use, or sell equipment constructed in accordance therewith. Specifications are subject to change without notice.
© 2010 Murata Power Solutions, Inc.

