

**SIPMOS<sup>®</sup> Small-Signal-Transistor**
**Features**

- P-Channel
- Enhancement mode
- Logic level
- Avalanche rated
- dv/dt rated
- Pb-free lead plating; RoHS compliant

**Product Summary**

$V_{DS}$	-60	V
$R_{DS(on),max}$	0.3	$\Omega$
$I_D$	-1.9	A

PG-SOT-223

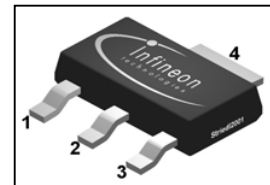

Type	Package	Tape and Reel Information	Marking
BSP 171 P	PG-SOT-223	L6327	171P

**Maximum ratings, at  $T_j=25\text{ °C}$ , unless otherwise specified**

Parameter	Symbol	Conditions	Value	Unit
			steady state	
Continuous drain current	$I_D$	$T_A=25\text{ °C}^{1)}$	-1.9	A
		$T_A=70\text{ °C}^{1)}$	-1.5	
Pulsed drain current	$I_{D,pulse}$	$T_A=25\text{ °C}$	-7.6	
Avalanche energy, single pulse	$E_{AS}$	$I_D=-1.9\text{ A}$ , $R_{GS}=25\ \Omega$	70	mJ
Reverse diode dv/dt	dv/dt	$I_D=-1.9\text{ A}$ , $V_{DS}=-48\text{ V}$ , $di/dt=-200\text{ A}/\mu\text{s}$ , $T_{j,max}=150\text{ °C}$	-6	kV/ $\mu\text{s}$
Gate source voltage	$V_{GS}$		$\pm 20$	V
Power dissipation	$P_{tot}$	$T_A=25\text{ °C}^{1)}$	1.8	W
Operating and storage temperature	$T_j$ , $T_{stg}$		-55 ... 150	$^{\circ}\text{C}$
IEC climatic category; DIN IEC 68-1			55/150/56	

Parameter	Symbol	Conditions	Values			Unit
			min.	typ.	max.	

**Thermal characteristics**

Thermal resistance, junction - soldering point	$R_{thJS}$		-	-	25	K/W
Thermal resistance, junction - ambient	$R_{thJA}$	minimal footprint, steady state	-	-	110	
		6 cm <sup>2</sup> cooling area <sup>1)</sup> , steady state	-	-	70	

**Electrical characteristics, at  $T_j=25\text{ °C}$ , unless otherwise specified**
**Static characteristics**

Drain-source breakdown voltage	$V_{(BR)DSS}$	$V_{GS}=0\text{ V}, I_D=-250\text{ }\mu\text{A}$	-60	-	-	V
Gate threshold voltage	$V_{GS(th)}$	$V_{DS}=V_{GS}, I_D=-460\text{ }\mu\text{A}$	-1	-1.5	-2	
Zero gate voltage drain current	$I_{DSS}$	$V_{DS}=-60\text{ V}, V_{GS}=0\text{ V}, T_j=25\text{ °C}$	-	-0.1	-1	$\mu\text{A}$
		$V_{DS}=-60\text{ V}, V_{GS}=0\text{ V}, T_j=125\text{ °C}$	-	-10	-100	
Gate-source leakage current	$I_{GSS}$	$V_{GS}=-20\text{ V}, V_{DS}=0\text{ V}$	-	-10	-100	nA
Drain-source on-state resistance	$R_{DS(on)}$	$V_{GS}=-4.5\text{ V}, I_D=-1.5\text{ A}$	-	0.3	0.45	$\Omega$
		$V_{GS}=-10\text{ V}, I_D=-1.9\text{ A}$	-	0.21	0.3	
Transconductance	$g_{fs}$	$ V_{DS} >2 I_D R_{DS(on)max}, I_D=-1.5\text{ A}$	1.4	2.7	-	S

<sup>1)</sup> Device on 40 mm x 40 mm x 1.5 mm epoxy PCB FR4 with 6 cm<sup>2</sup> (one layer, 70  $\mu\text{m}$  thick) copper area for drain connection. PCB is vertical in still air.

Parameter	Symbol	Conditions	Values			Unit
			min.	typ.	max.	

**Dynamic characteristics**

Input capacitance	$C_{iss}$	$V_{GS}=0\text{ V},$ $V_{DS}=-25\text{ V}, f=1\text{ MHz}$	-	365	460	pF
Output capacitance	$C_{oss}$		-	105	135	
Reverse transfer capacitance	$C_{rss}$		-	40	55	
Turn-on delay time	$t_{d(on)}$	$V_{DD}=-25\text{ V},$ $V_{GS}=-10\text{ V},$ $I_D=-1.9\text{ A}, R_G=6\ \Omega$	-	6	8	ns
Rise time	$t_r$		-	25	33	
Turn-off delay time	$t_{d(off)}$		-	208	276	
Fall time	$t_f$		-	87	130	

**Gate Charge Characteristics<sup>2)</sup>**

Gate to source charge	$Q_{gs}$	$V_{DD}=-48\text{ V}, I_D=1.9\text{ A},$ $V_{GS}=0\text{ to }-10\text{ V}$	-	-1.2	-1.6	nC
Gate to drain charge	$Q_{gd}$		-	-5	-7	
Gate charge total	$Q_g$		-	-13	-20	
Gate plateau voltage	$V_{plateau}$		-	-3	-	V
Output charge	$Q_{oss}$	$V_{DD}=-15\text{ V}, V_{GS}=0\text{ V}$	-	-5	-7	

**Reverse Diode**

Diode continuous forward current	$I_S$	$T_A=25\text{ }^\circ\text{C}$	-	-	-1.9	A
Diode pulse current	$I_{S,pulse}$		-	-	-7.6	
Diode forward voltage	$V_{SD}$	$V_{GS}=0\text{ V}, I_F=1.9\text{ A},$ $T_j=25\text{ }^\circ\text{C}$	-	-0.84	-1.1	V
Reverse recovery time	$t_{rr}$	$V_R=-30\text{ V}, I_F= I_S ,$ $di_F/dt=100\text{ A}/\mu\text{s}$	-	80	120	ns
Reverse recovery charge	$Q_{rr}$		-	-125	-190	nC

<sup>2)</sup> See figure 16 for gate charge parameter definition

**1 Power dissipation**

$$P_{tot} = f(T_A)$$

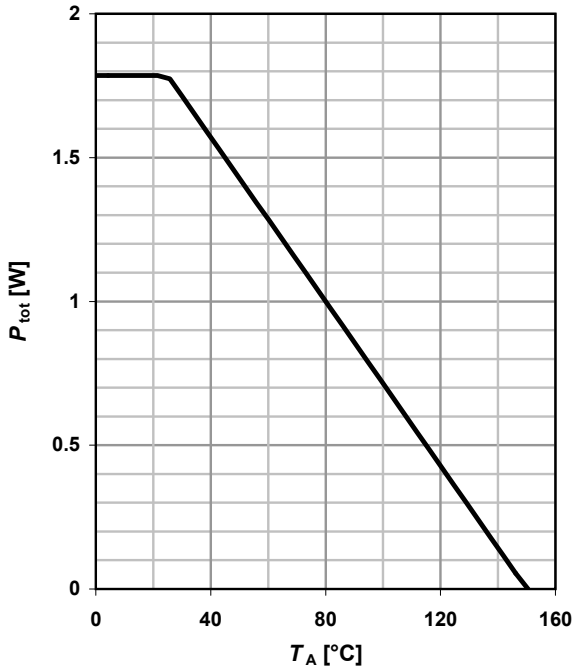

**2 Drain current**

$$I_D = f(T_A); |V_{GS}| \geq 10 \text{ V}$$

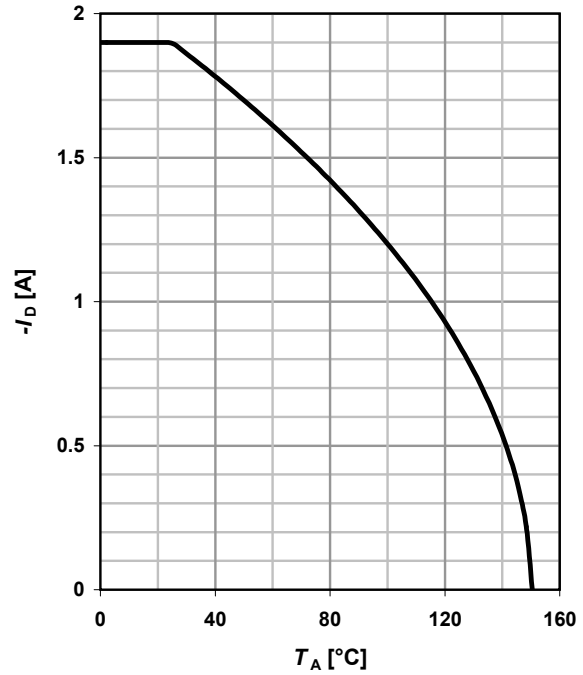

**3 Safe operating area**

$$I_D = f(V_{DS}); T_A = 25 \text{ °C}^1; D = 0$$

parameter:  $t_p$

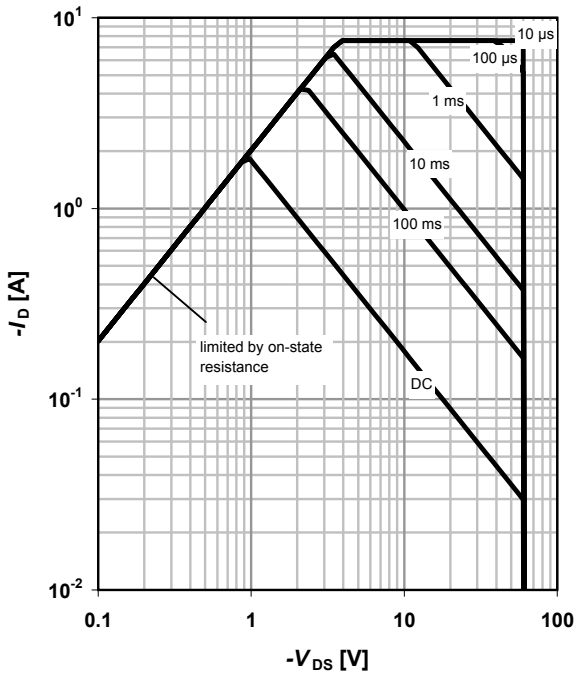

**4 Max. transient thermal impedance**

$$Z_{thJA} = f(t_p)$$

parameter:  $D = t_p/T$

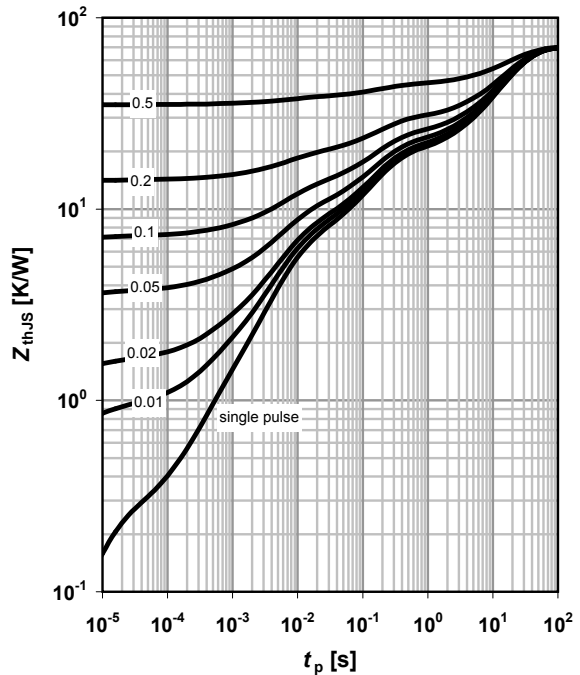

**5 Typ. output characteristics**

$$I_D = f(V_{DS}); T_j = 25\text{ }^\circ\text{C}$$

parameter:  $V_{GS}$

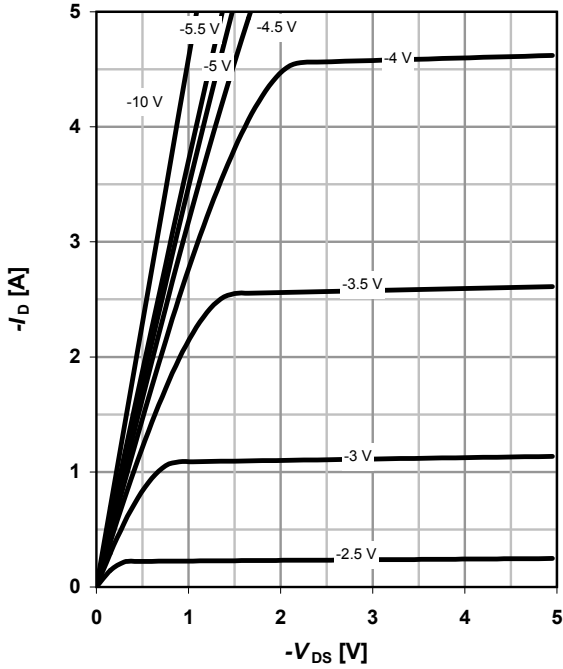

**6 Typ. drain-source on resistance**

$$R_{DS(on)} = f(I_D); T_j = 25\text{ }^\circ\text{C}$$

parameter:  $V_{GS}$

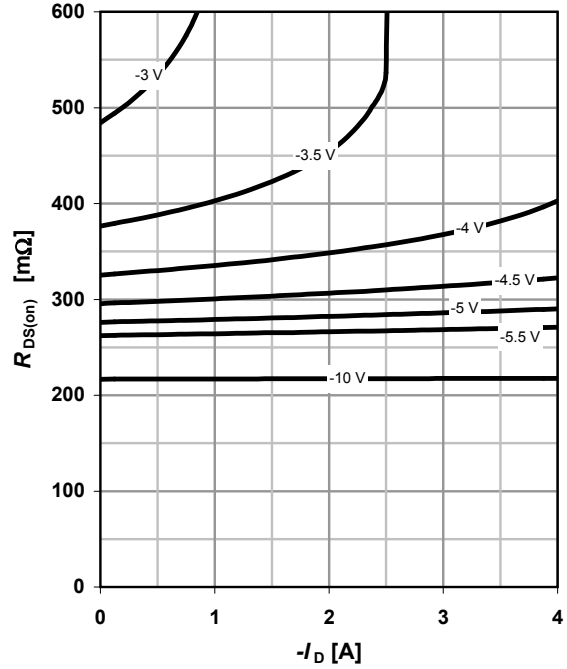

**7 Typ. transfer characteristics**

$$I_D = f(V_{GS}); |V_{DS}| > 2|I_D|R_{DS(on)max}$$

parameter:  $T_j$

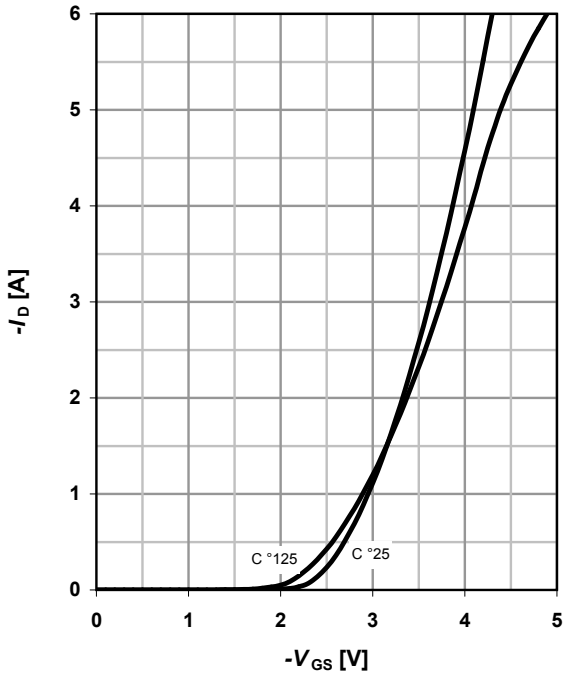

**8 Typ. forward transconductance**

$$g_{fs} = f(I_D); T_j = 25\text{ }^\circ\text{C}$$

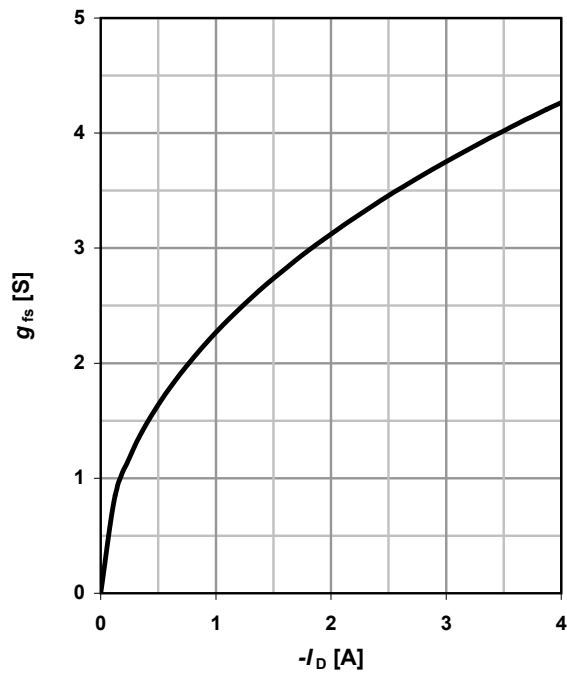

**9 Drain-source on-state resistance**

$$R_{DS(on)} = f(T_j); I_D = -1.9 \text{ A}; V_{GS} = -10 \text{ V}$$

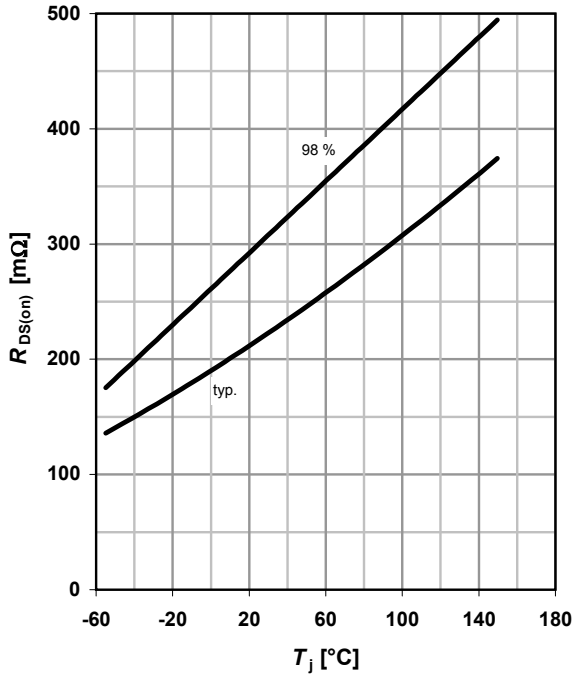

**10 Typ. gate threshold voltage**

$$V_{GS(th)} = f(T_j); V_{GS} = V_{DS}; I_D = -460 \mu\text{A}$$

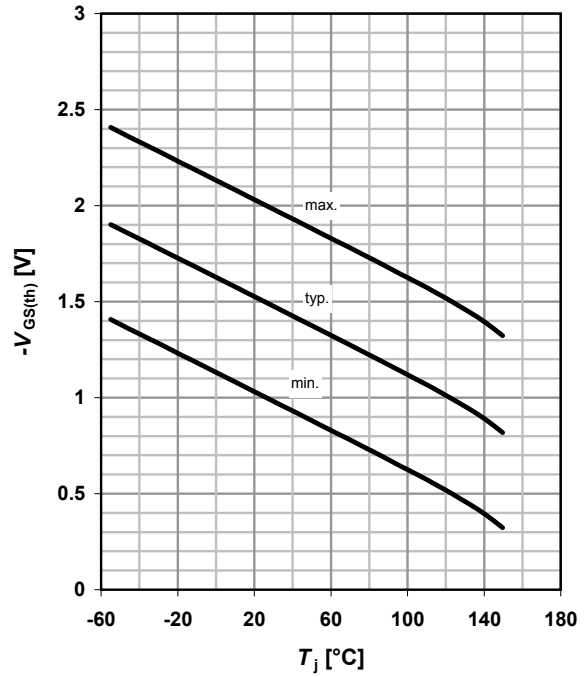

**11 Typ. capacitances**

$$C = f(V_{DS}); V_{GS} = 0 \text{ V}; f = 1 \text{ MHz}$$

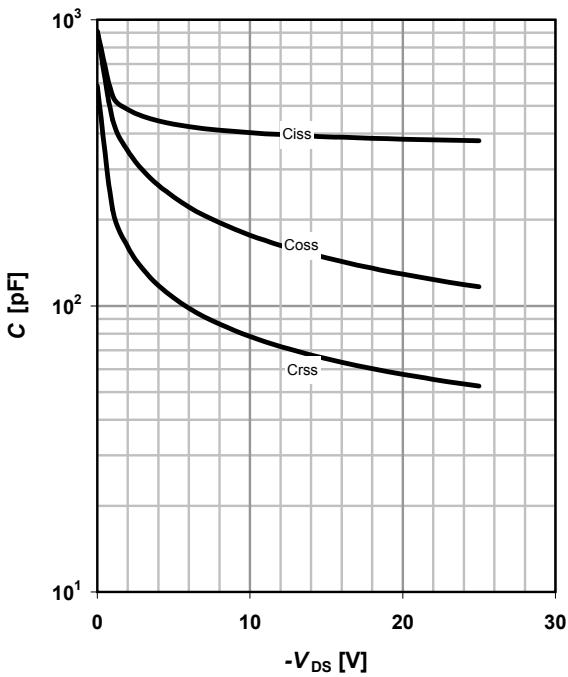

**12 Forward characteristics of reverse diode**

$$I_F = f(V_{SD})$$

parameter:  $T_j$

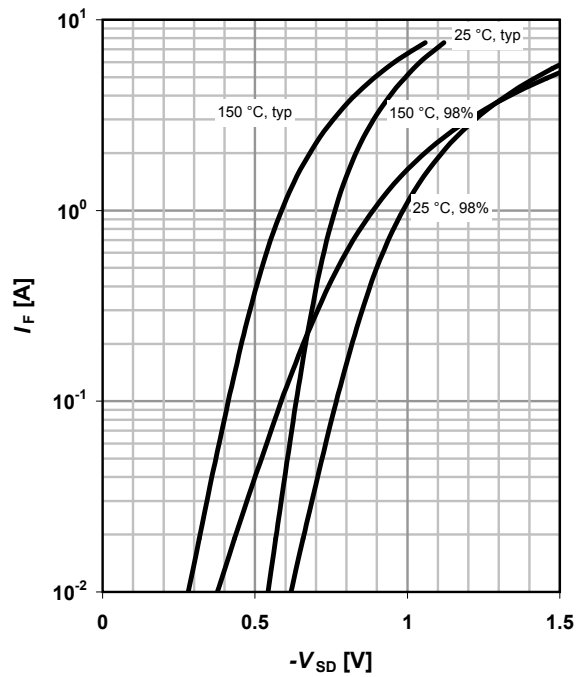

**13 Avalanche characteristics**

$I_{AS}=f(t_{AV}); R_{GS}=25 \Omega$

parameter:  $T_{j(start)}$

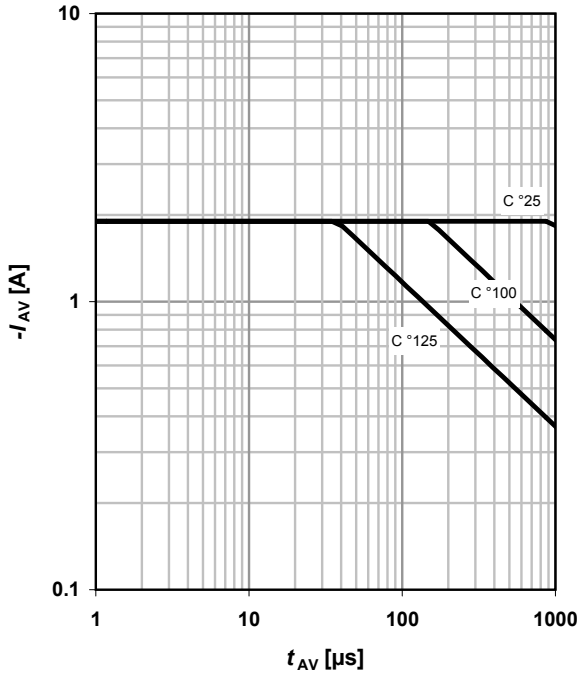

**14 Typ. gate charge**

$V_{GS}=f(Q_{gate}); I_D=-1.9 \text{ A pulsed}$

parameter:  $V_{DD}$

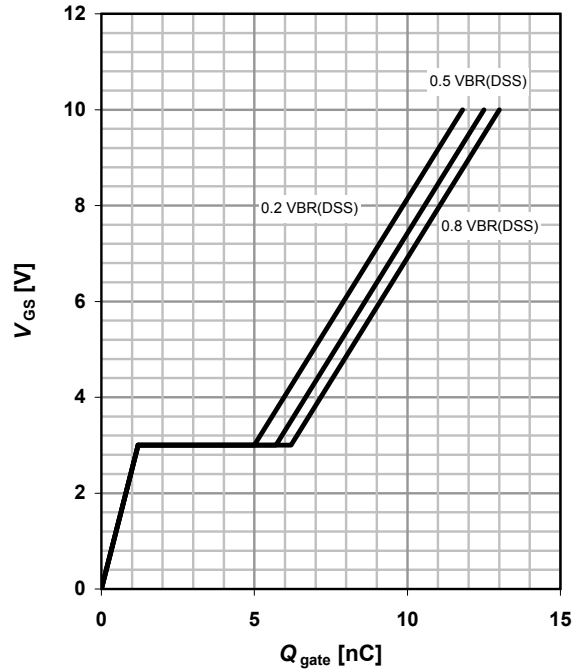

**15 Drain-source breakdown voltage**

$V_{BR(DSS)}=f(T_j); I_D=-1 \text{ mA}$

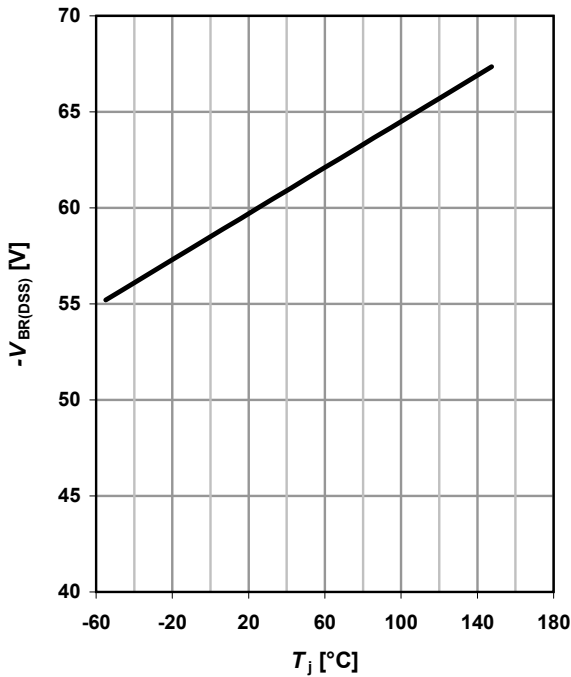

**16 Gate charge waveforms**

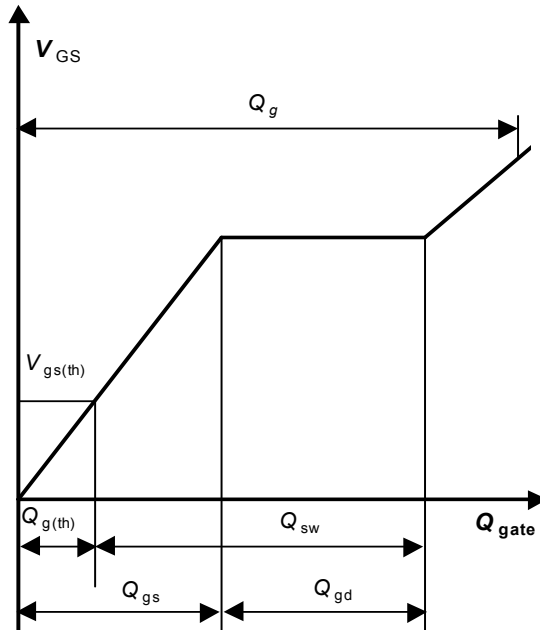

Package Outline

SOT-223: Outline

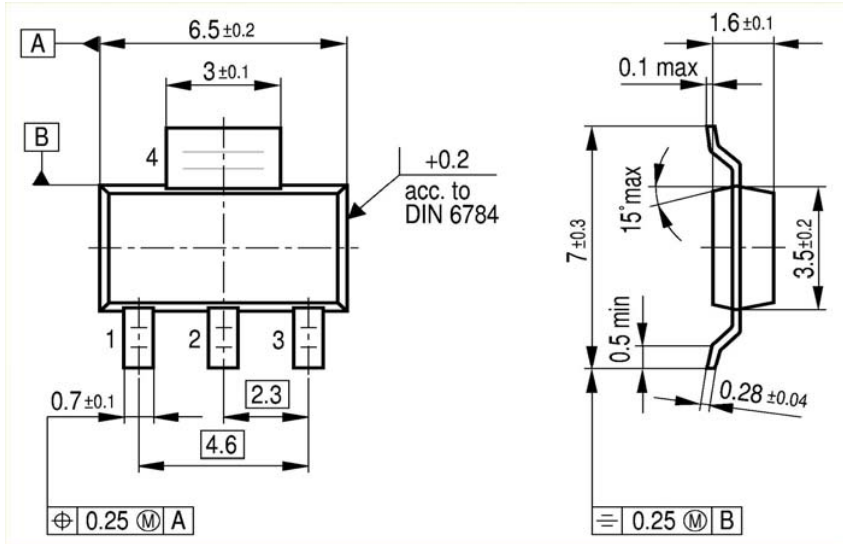

Footprint

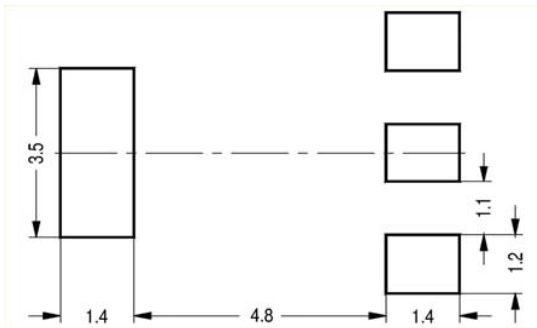

Packaging

Tape

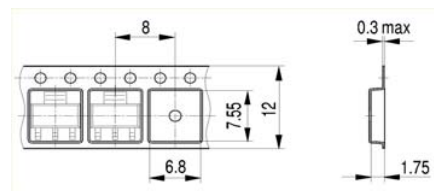

Dimensions in mm



**Published by**  
**Infineon Technologies AG**  
**Bereich Kommunikation**  
**St.-Martin-Straße 53**  
**D-81541 München**  
**© Infineon Technologies AG 1999**  
**All Rights Reserved.**

**Attention please!**

The information herein is given to describe certain components and shall not be considered as warranted characteristics.

Terms of delivery and rights to technical change reserved.

We hereby disclaim any and all warranties, including but not limited to warranties of non-infringement, regarding circuits, descriptions and charts stated herein.

Infineon Technologies is an approved CECC manufacturer.

**Information**

For further information on technology, delivery terms and conditions and prices, please contact your nearest Infineon Technologies office in Germany or our Infineon Technologies representatives worldwide (see address list).

**Warnings**

Due to technical requirements, components may contain dangerous substances.

For information on the types in question, please contact your nearest Infineon Technologies office.

Infineon Technologies' components may only be used in life-support devices or systems with the expressed written approval of Infineon Technologies if a failure of such components can reasonably be expected to cause the failure of that life-support device or system, or to affect the safety or effectiveness of that device or system. Life support devices or systems are intended to be implanted in the human body, or to support and/or maintain and sustain and/or protect human life. If they fail, it is reasonable to assume that the health of the user or other persons may be endangered.