

## Dual N-Channel 20-V (D-S) MOSFET with Schottky Diode

PRODUCT SUMMARY				
	V <sub>DS</sub> (V)	R <sub>DS(on)</sub> (Ω)	I <sub>D</sub> (A) <sup>a</sup>	Q <sub>g</sub> (Typ.)
Channel-1	20	0.0094 at V <sub>GS</sub> = 10 V	14.1	9.6
		0.0125 at V <sub>GS</sub> = 4.5 V	12.2	
Channel-2	20	0.008 at V <sub>GS</sub> = 10 V	20	14.1
		0.0095 at V <sub>GS</sub> = 4.5 V	18.9	

SCHOTTKY PRODUCT SUMMARY		
V <sub>DS</sub> (V)	V <sub>SD</sub> (V) Diode Forward Voltage	I <sub>F</sub> (A)
20	0.55 V at 2.5 A	2

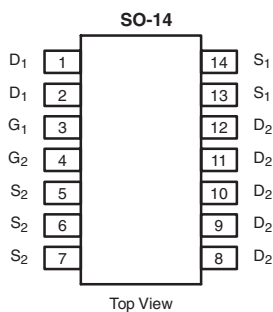

Ordering Information: Si4340CDY-T1-E3 (Lead (Pb)-free)  
Si4340CDY-T1-GE3 (Lead (Pb)-free and Halogen-free)

### FEATURES

- Halogen-free According to IEC 61249-2-21 Definition
- TrenchFET<sup>®</sup> Power MOSFET
- 100 % R<sub>g</sub> Tested
- 100 % UIS Tested
- Compliant to RoHS Directive 2002/95/EC



**RoHS**  
COMPLIANT  
HALOGEN  
**FREE**  
Available

### APPLICATIONS

- DC/DC Converters
  - Game Stations
  - Notebook PC Logic

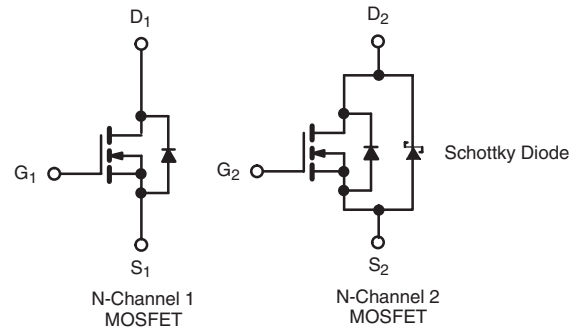

ABSOLUTE MAXIMUM RATINGS T <sub>A</sub> = 25 °C, unless otherwise noted					
Parameter	Symbol	Channel-1	Channel-2	Unit	
Drain-Source Voltage	V <sub>DS</sub>	20	20	V	
Gate-Source Voltage	V <sub>GS</sub>	± 20	± 16		
Continuous Drain Current (T <sub>J</sub> = 150 °C)	I <sub>D</sub>	T <sub>C</sub> = 25 °C	14.1	20	A
		T <sub>C</sub> = 70 °C	11.2	16.5	
		T <sub>A</sub> = 25 °C	11.5 <sup>b, c</sup>	15.2 <sup>b, c</sup>	
		T <sub>A</sub> = 70 °C	9.2 <sup>b, c</sup>	12.2 <sup>b, c</sup>	
Pulsed Drain Current	I <sub>DM</sub>	40	50	A	
Source-Drain Current Diode Current	I <sub>S</sub>	T <sub>C</sub> = 25 °C	2.5		4.5
		T <sub>A</sub> = 25 °C	1.7 <sup>b, c</sup>	2.5 <sup>b, c</sup>	
Single Pulse Avalanche Current	I <sub>AS</sub>	5		mJ	
Single Pulse Avalanche Energy	E <sub>AS</sub>	1.25			
Maximum Power Dissipation	P <sub>D</sub>	T <sub>C</sub> = 25 °C	3	5.4	W
		T <sub>C</sub> = 70 °C	1.9	3.5	
		T <sub>A</sub> = 25 °C	2 <sup>b, c</sup>	3 <sup>b, c</sup>	
		T <sub>A</sub> = 70 °C	1.3 <sup>b, c</sup>	1.9 <sup>b, c</sup>	
Operating Junction and Storage Temperature Range	T <sub>J</sub> , T <sub>stg</sub>	- 55 to 150		°C	

THERMAL RESISTANCE RATINGS							
Parameter	Symbol	Channel-1		Channel-2		Unit	
		Typ.	Max.	Typ.	Max.		
Maximum Junction-to-Ambient <sup>b, d</sup>	R <sub>thJA</sub>	53	62.5	35	42	°C/W	
Maximum Junction-to-Foot (Drain)	R <sub>thJF</sub>	35	42	18	23		

Notes:

- Based on T<sub>C</sub> = 25 °C.
- Surface Mounted on 1" x 1" FR4 board.
- t = 10 s.
- Maximum under Steady State conditions for channel 1 is 110 °C/W and channel 2 is 87 °C/W.

SPECIFICATIONS $T_J = 25\text{ }^\circ\text{C}$ , unless otherwise noted								
Parameter	Symbol	Test Conditions	Min.	Typ.	Max.	Unit		
<b>Static</b>								
Drain-Source Breakdown Voltage	$V_{DS}$	$V_{GS} = 0\text{ V}, I_D = 250\text{ }\mu\text{A}$	Ch-1	20			V	
		$V_{GS} = 0\text{ V}, I_D = 250\text{ }\mu\text{A}$	Ch-2	20				
$V_{DS}$ Temperature Coefficient	$\Delta V_{DS}/T_J$	$I_D = 250\text{ }\mu\text{A}$	Ch-1		20		mV/ $^\circ\text{C}$	
		$I_D = 25\text{ mA}$	Ch-2		22			
$V_{GS(th)}$ Temperature Coefficient	$\Delta V_{GS(th)}/T_J$	$I_D = 250\text{ }\mu\text{A}$	Ch-1		- 5.5			
		$I_D = 25\text{ mA}$	Ch-2		- 2.5			
Gate Threshold Voltage	$V_{GS(th)}$	$V_{DS} = V_{GS}, I_D = 250\text{ }\mu\text{A}$	Ch-1	1		3	V	
		$V_{DS} = V_{GS}, I_D = 250\text{ }\mu\text{A}$	Ch-2	0.8		2.2		
Gate-Body Leakage	$I_{GSS}$	$V_{DS} = 0\text{ V}, V_{GS} = \pm 20\text{ V}$	Ch-1			100	nA	
		$V_{DS} = 0\text{ V}, V_{GS} = \pm 16\text{ V}$	Ch-2			100		
Zero Gate Voltage Drain Current	$I_{DSS}$	$V_{DS} = 20\text{ V}, V_{GS} = 0\text{ V}$	Ch-1			1	$\mu\text{A}$	
		$V_{DS} = 20\text{ V}, V_{GS} = 0\text{ V}$	Ch-2			100		
		$V_{DS} = 20\text{ V}, V_{GS} = 0\text{ V}, T_J = 85\text{ }^\circ\text{C}$	Ch-1			15		
		$V_{DS} = 20\text{ V}, V_{GS} = 0\text{ V}, T_J = 85\text{ }^\circ\text{C}$	Ch-2			10 000		
On-State Drain Current <sup>b</sup>	$I_{D(on)}$	$V_{DS} \geq 5\text{ V}, V_{GS} = 10\text{ V}$	Ch-1	20			A	
		$V_{DS} \geq 5\text{ V}, V_{GS} = 10\text{ V}$	Ch-2	30				
Drain-Source On-State Resistance <sup>b</sup>	$R_{DS(on)}$	$V_{GS} = 10\text{ V}, I_D = 11.5\text{ A}$	Ch-1		0.0077	0.0094	$\Omega$	
		$V_{GS} = 10\text{ V}, I_D = 15.2\text{ A}$	Ch-2		0.0065	0.008		
		$V_{GS} = 4.5\text{ V}, I_D = 10\text{ A}$	Ch-1		0.010	0.0125		
		$V_{GS} = 4.5\text{ V}, I_D = 14\text{ A}$	Ch-2		0.0075	0.0095		
Forward Transconductance <sup>b</sup>	$g_{fs}$	$V_{DS} = 10\text{ V}, I_D = 11.5\text{ A}$	Ch-1		45		S	
		$V_{DS} = 10\text{ V}, I_D = 15.2\text{ A}$	Ch-2		73			
<b>Dynamic<sup>a</sup></b>								
Input Capacitance	$C_{iss}$	Channel-1 $V_{DS} = 10\text{ V}, V_{GS} = 0\text{ V}, f = 1\text{ MHz}$	Ch-1		1300		pF	
			Ch-2		1900			
Output Capacitance	$C_{oss}$		Ch-1		330			
			Ch-2		500			
Reverse Transfer Capacitance	$C_{rss}$	Channel-2 $V_{DS} = 10\text{ V}, V_{GS} = 0\text{ V}, f = 1\text{ MHz}$	Ch-1		150			
			Ch-2		160			
Total Gate Charge	$Q_g$		$V_{DS} = 10\text{ V}, V_{GS} = 10\text{ V}, I_D = 11.5\text{ A}$	Ch-1		21	32	nC
				Ch-2		31	47	
		$V_{DS} = 10\text{ V}, V_{GS} = 4.5\text{ V}, I_D = 11.5\text{ A}$	Ch-1		9.6	15		
			Ch-2		14.1	22		
Gate-Source Charge	$Q_{gs}$	$V_{DS} = 10\text{ V}, V_{GS} = 4.5\text{ V}, I_D = 11.5\text{ A}$	Ch-1		4			
Ch-2			5					
Gate-Drain Charge	$Q_{gd}$	$V_{DS} = 10\text{ V}, V_{GS} = 4.5\text{ V}, I_D = 15.2\text{ A}$	Ch-1		3			
			Ch-2		3.5			
Gate Resistance	$R_g$		$f = 1\text{ MHz}$	Ch-1		0.65	1.2	$\Omega$
				Ch-2		1.4	2.8	

## Notes:

- a. Guaranteed by design, not subject to production testing.  
b. Pulse test; pulse width  $\leq 300\text{ }\mu\text{s}$ , duty cycle  $\leq 2\%$ .



<b>SPECIFICATIONS</b> $T_J = 25\text{ }^\circ\text{C}$ , unless otherwise noted							
Parameter	Symbol	Test Conditions	Min.	Typ.	Max.	Unit	
<b>Dynamic<sup>a</sup></b>							
Turn-On Delay Time	$t_{d(on)}$	Channel-1 $V_{DD} = 10\text{ V}$ , $R_L = 1.1\ \Omega$ $I_D \cong 9.2\text{ A}$ , $V_{GEN} = 4.5\text{ V}$ , $R_g = 1\ \Omega$	Ch-1		20	30	ns
Rise Time	$t_r$		Ch-2		22	35	
Turn-Off Delay Time	$t_{d(off)}$	Channel-2 $V_{DD} = 10\text{ V}$ , $R_L = 1\ \Omega$ $I_D \cong 10\text{ A}$ , $V_{GEN} = 4.5\text{ V}$ , $R_g = 1\ \Omega$	Ch-1		10	15	
			Ch-2		10	15	
Fall Time	$t_f$	Channel-1 $V_{DD} = 10\text{ V}$ , $R_L = 1.1\ \Omega$ $I_D \cong 9.2\text{ A}$ , $V_{GEN} = 10\text{ V}$ , $R_g = 1\ \Omega$	Ch-1		20	30	
			Ch-2		32	50	
Turn-On Delay Time	$t_{d(on)}$	Channel-2 $V_{DD} = 10\text{ V}$ , $R_L = 1\ \Omega$ $I_D \cong 10\text{ A}$ , $V_{GEN} = 4.5\text{ V}$ , $R_g = 1\ \Omega$	Ch-1		10	15	
			Ch-2		10	15	
Rise Time	$t_r$	Channel-1 $V_{DD} = 10\text{ V}$ , $R_L = 1.1\ \Omega$ $I_D \cong 9.2\text{ A}$ , $V_{GEN} = 10\text{ V}$ , $R_g = 1\ \Omega$	Ch-1		10	15	
			Ch-2		10	15	
Turn-Off Delay Time	$t_{d(off)}$	Channel-2 $V_{DD} = 10\text{ V}$ , $R_L = 1\ \Omega$ $I_D \cong 10\text{ A}$ , $V_{GEN} = 10\text{ V}$ , $R_g = 1\ \Omega$	Ch-1		20	30	
			Ch-2		25	40	
Fall Time	$t_f$	Channel-1 $V_{DD} = 10\text{ V}$ , $R_L = 1.1\ \Omega$ $I_D \cong 9.2\text{ A}$ , $V_{GEN} = 10\text{ V}$ , $R_g = 1\ \Omega$	Ch-1		10	15	
			Ch-2		10	15	
<b>Drain-Source Body Diode Characteristics</b>							
Continuous Source-Drain Diode Current	$I_S$	$T_C = 25\text{ }^\circ\text{C}$	Ch-1			2.5	A
			Ch-2			4.5	
Pulse Diode Forward Current <sup>a</sup>	$I_{SM}$		Ch-1			40	
			Ch-2			50	
Body Diode Voltage	$V_{SD}$	$I_S = 9.2\text{ A}$ $I_S = 2.5\text{ A}$	Ch-1		0.8	1.2	V
			Ch-2		0.45	0.55	
Body Diode Reverse Recovery Time	$t_{rr}$	Channel-1 $I_F = 9.2\text{ A}$ , $di/dt = 100\text{ A}/\mu\text{s}$ , $T_J = 25\text{ }^\circ\text{C}$	Ch-1		30	60	ns
			Ch-2		30	60	
Body Diode Reverse Recovery Charge	$Q_{rr}$	Channel-2 $I_F = 2.5\text{ A}$ , $di/dt = 100\text{ A}/\mu\text{s}$ , $T_J = 25\text{ }^\circ\text{C}$	Ch-1		15	25	nC
			Ch-2		20	30	
Reverse Recovery Fall Time	$t_a$		Ch-1		12		ns
			Ch-2		14		
Reverse Recovery Rise Time	$t_b$		Ch-1		18		
			Ch-2		16		

Notes:

- a. Guaranteed by design, not subject to production testing.
- b. Pulse test; pulse width  $\leq 300\ \mu\text{s}$ , duty cycle  $\leq 2\%$ .

Stresses beyond those listed under "Absolute Maximum Ratings" may cause permanent damage to the device. These are stress ratings only, and functional operation of the device at these or any other conditions beyond those indicated in the operational sections of the specifications is not implied. Exposure to absolute maximum rating conditions for extended periods may affect device reliability.

## CHANNEL-1 TYPICAL CHARACTERISTICS 25 °C, unless otherwise noted

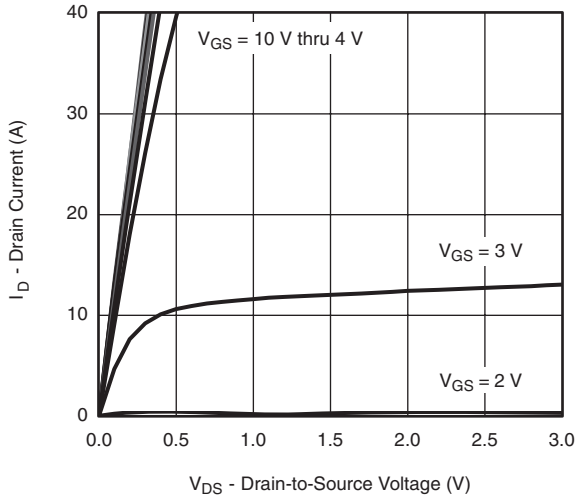

**Output Characteristics**

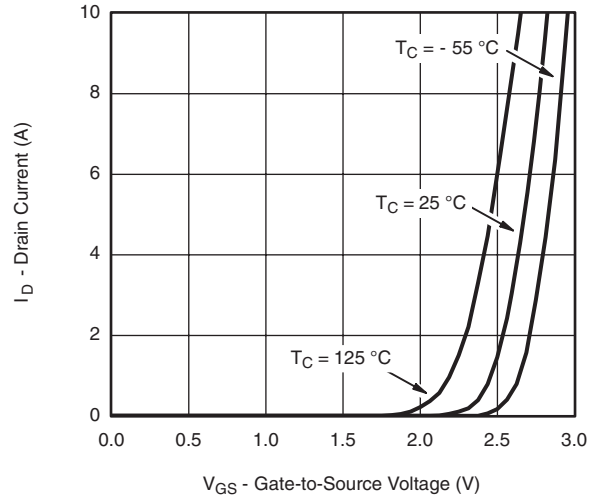

**Transfer Characteristics**

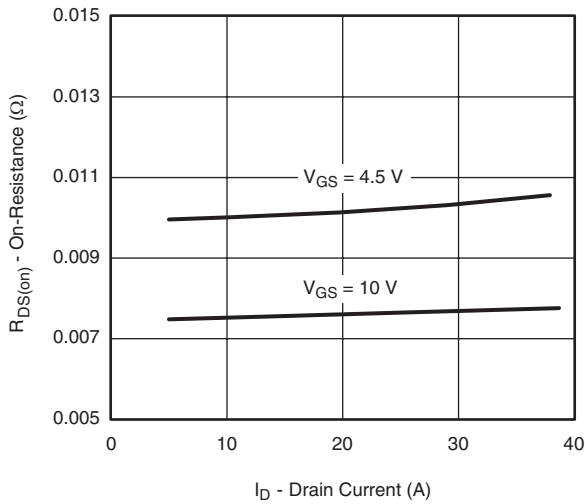

**On-Resistance vs. Drain Current**

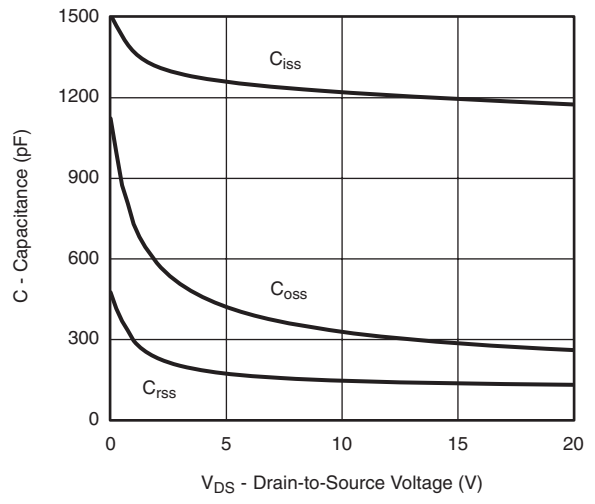

**Capacitance**

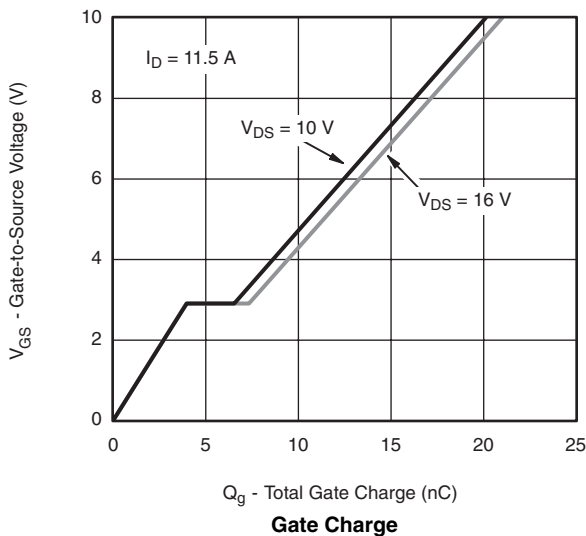

**Gate Charge**

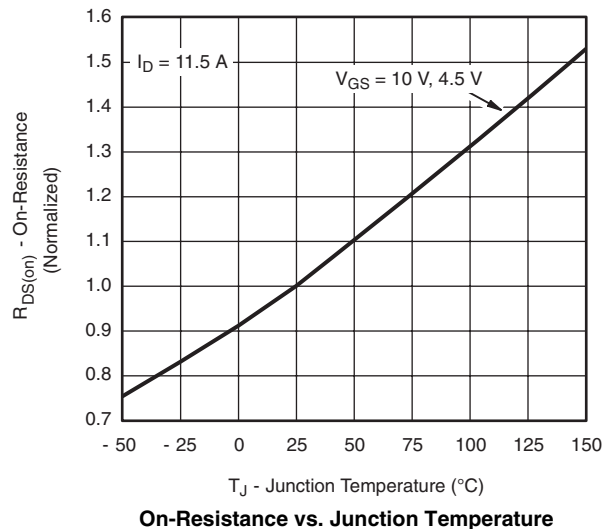

**On-Resistance vs. Junction Temperature**

**CHANNEL-1 TYPICAL CHARACTERISTICS** 25 °C, unless otherwise noted

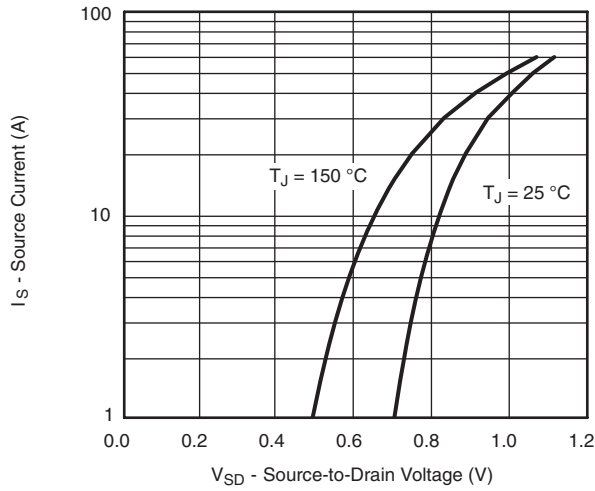

**Source-Drain Diode Forward Voltage**

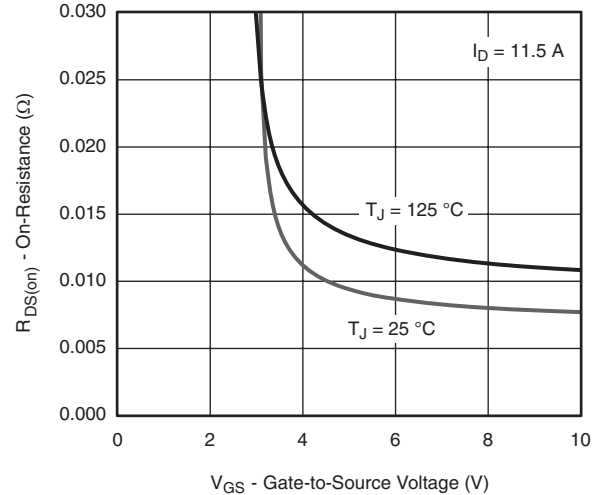

**On-Resistance vs. Gate-to-Source Voltage**

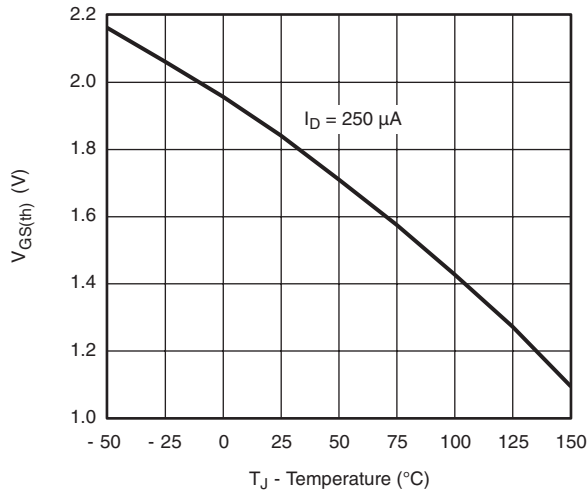

**Threshold Voltage**

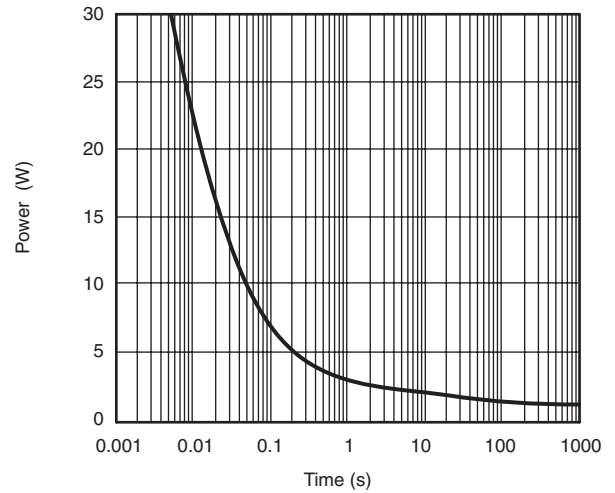

**Single Pulse Power**

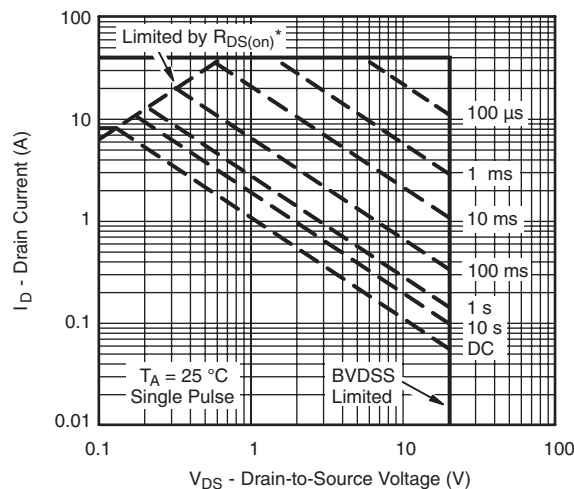

**Safe Operating Area, Junction-to-Ambient**  
\*  $V_{GS} >$  minimum  $V_{GS}$  at which  $R_{DS(on)}$  is specified

## CHANNEL-1 TYPICAL CHARACTERISTICS 25 °C, unless otherwise noted

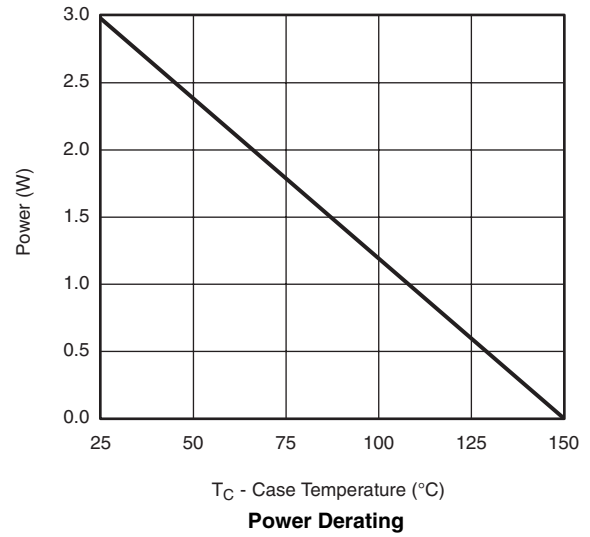
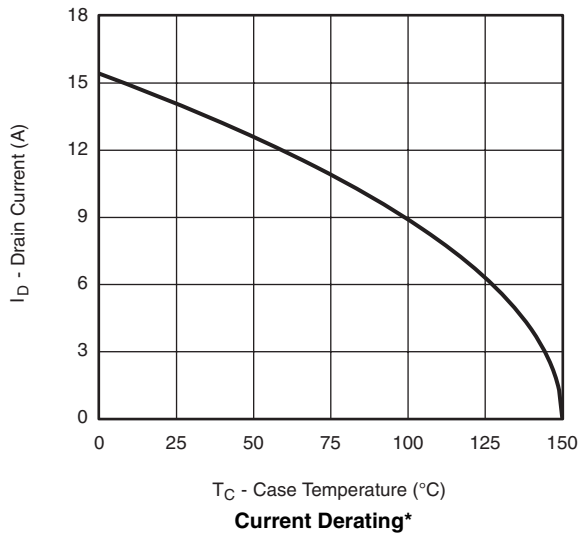

\* The power dissipation  $P_D$  is based on  $T_{J(max)} = 150$  °C, using junction-to-case thermal resistance, and is more useful in settling the upper dissipation limit for cases where additional heatsinking is used. It is used to determine the current rating, when this rating falls below the package limit.

**CHANNEL-1 TYPICAL CHARACTERISTICS** 25 °C, unless otherwise noted

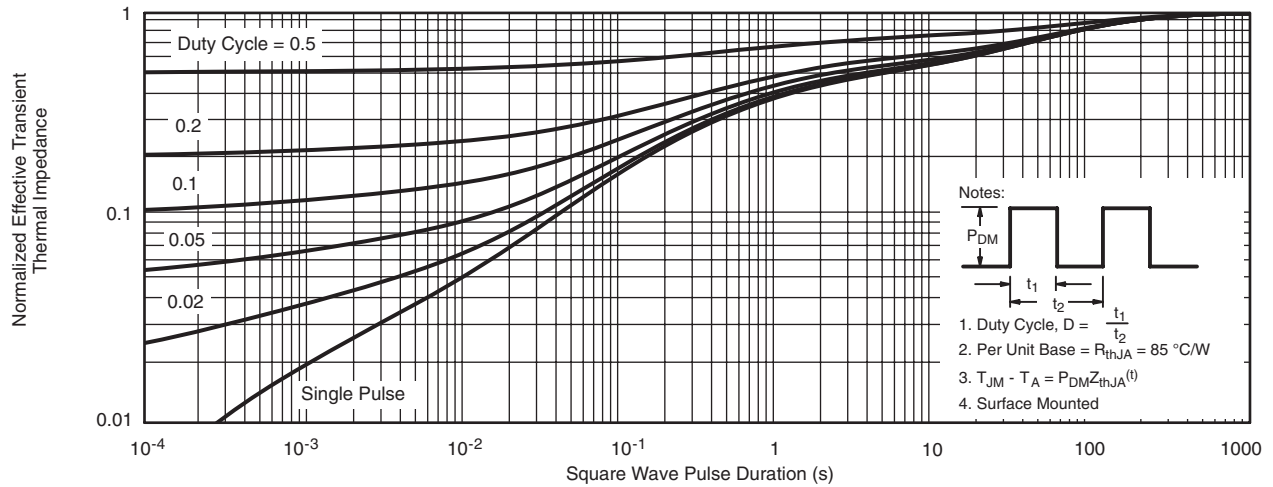

**Normalized Thermal Transient Impedance, Junction-to-Ambient**

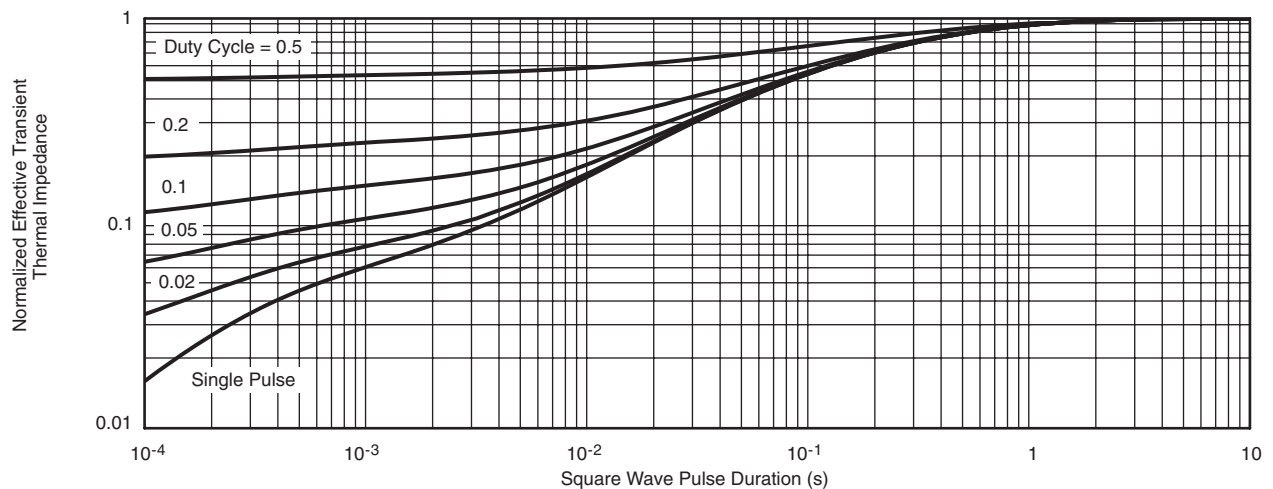

**Normalized Thermal Transient Impedance, Junction-to-Foot**

## CHANNEL-2 TYPICAL CHARACTERISTICS 25 °C, unless otherwise noted

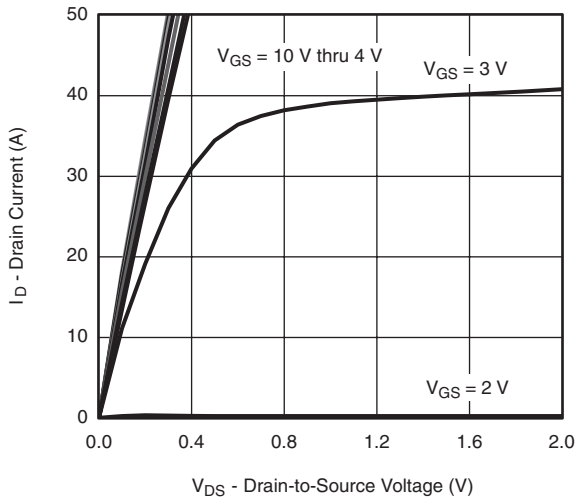

**Output Characteristics**

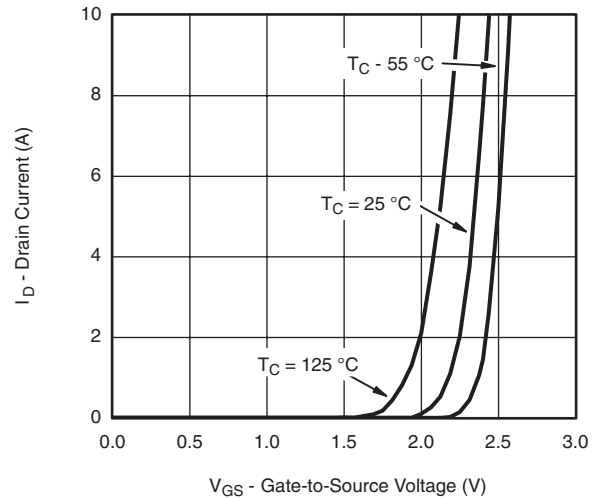

**Transfer Characteristics**

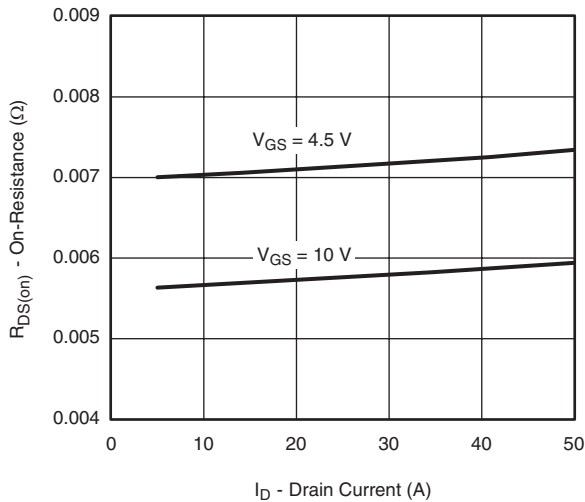

**On-Resistance vs. Drain Current**

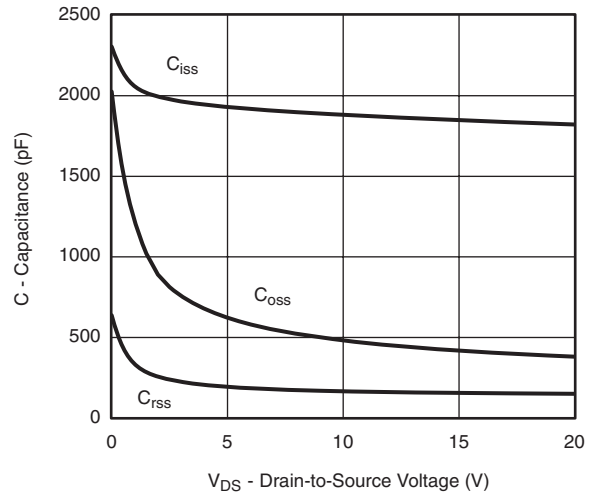

**Capacitance**

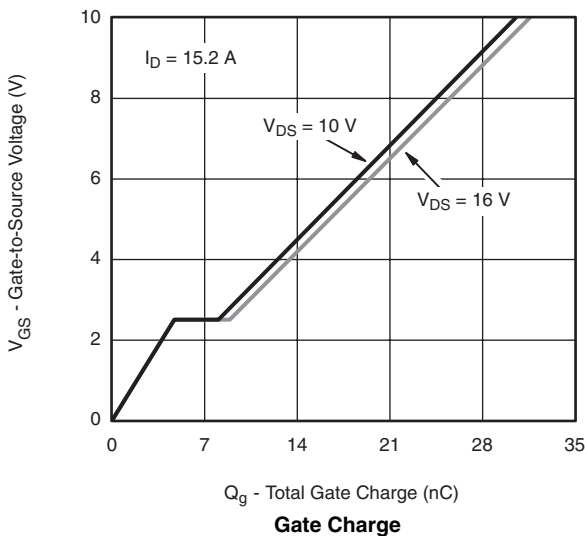

**Gate Charge**

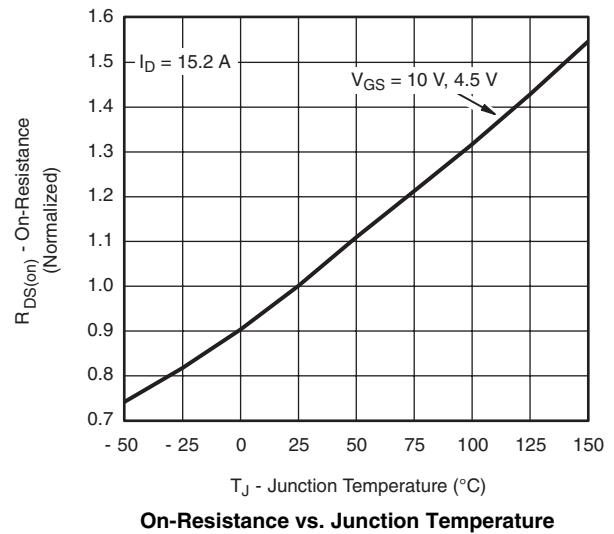

**On-Resistance vs. Junction Temperature**



## CHANNEL-2 TYPICAL CHARACTERISTICS 25 °C, unless otherwise noted

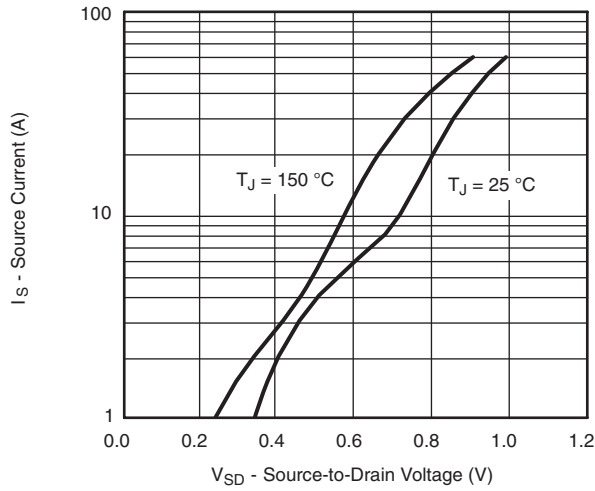

Source-Drain Diode Forward Voltage

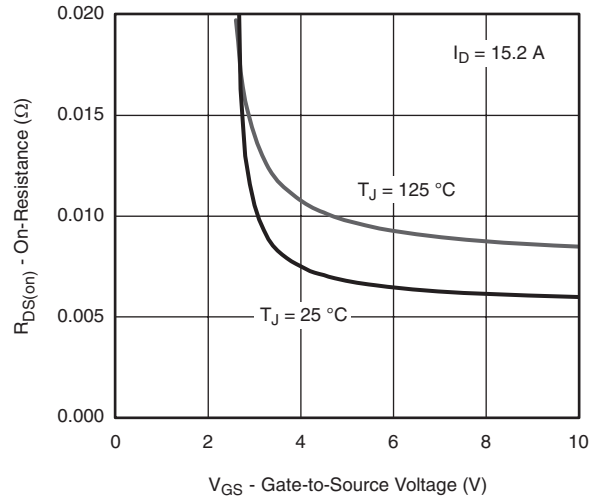

On-Resistance vs. Gate-to-Source Voltage

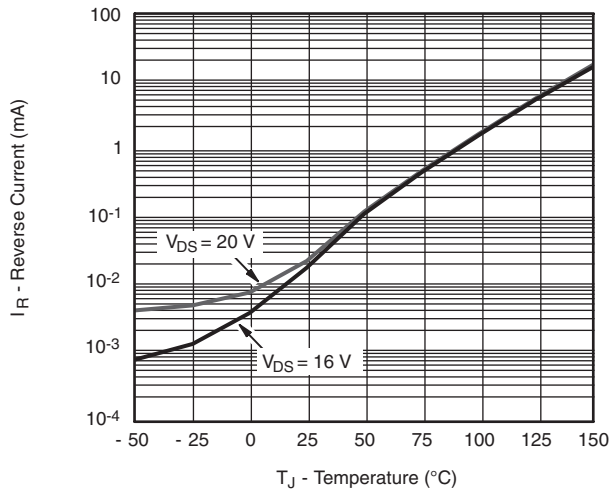

Reverse Current vs. Junction Temperature

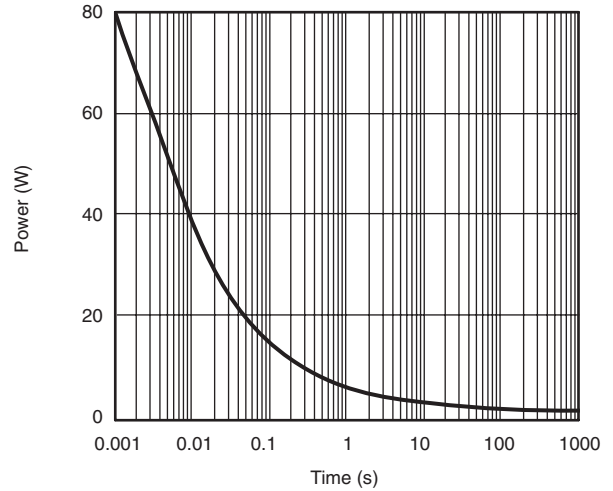

Single Pulse Power

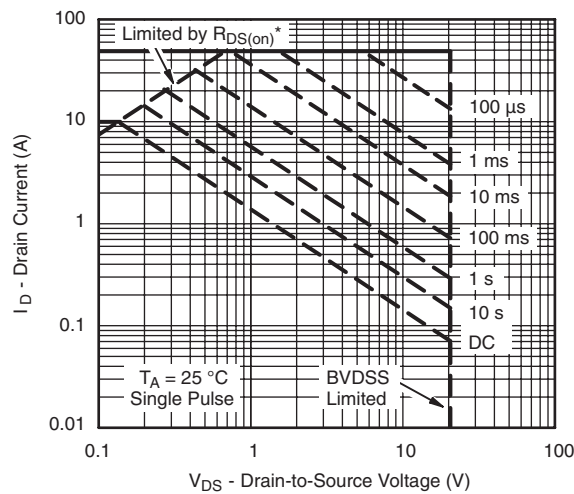

\*  $V_{GS} >$  minimum  $V_{GS}$  at which  $R_{DS(on)}$  is specified

Safe Operating Area, Junction-to-Ambient

## CHANNEL-2 TYPICAL CHARACTERISTICS 25 °C, unless otherwise noted

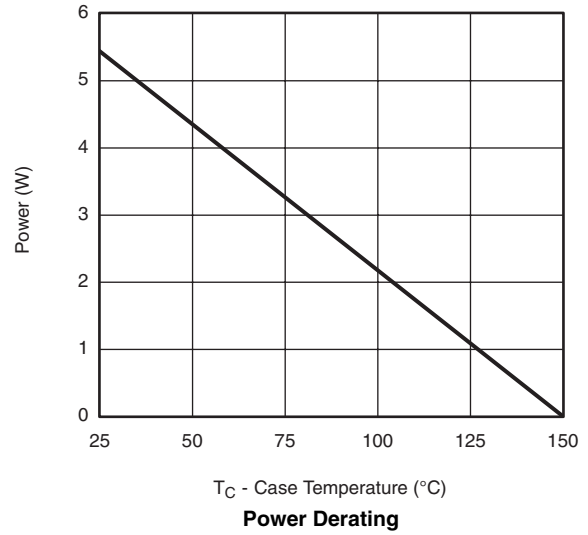
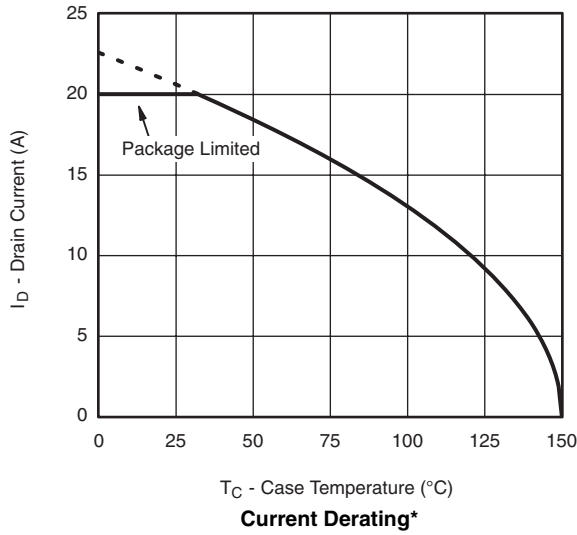

\* The power dissipation  $P_D$  is based on  $T_{J(max)} = 150\text{ °C}$ , using junction-to-case thermal resistance, and is more useful in settling the upper dissipation limit for cases where additional heatsinking is used. It is used to determine the current rating, when this rating falls below the package limit.

**CHANNEL-2 TYPICAL CHARACTERISTICS** 25 °C, unless otherwise noted

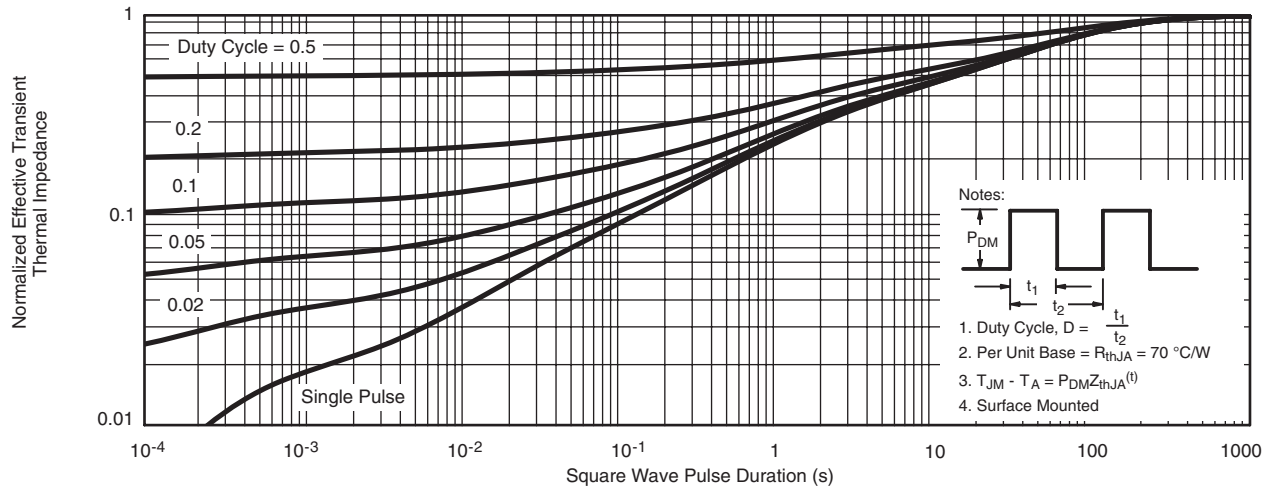

**Normalized Thermal Transient Impedance, Junction-to-Ambient**

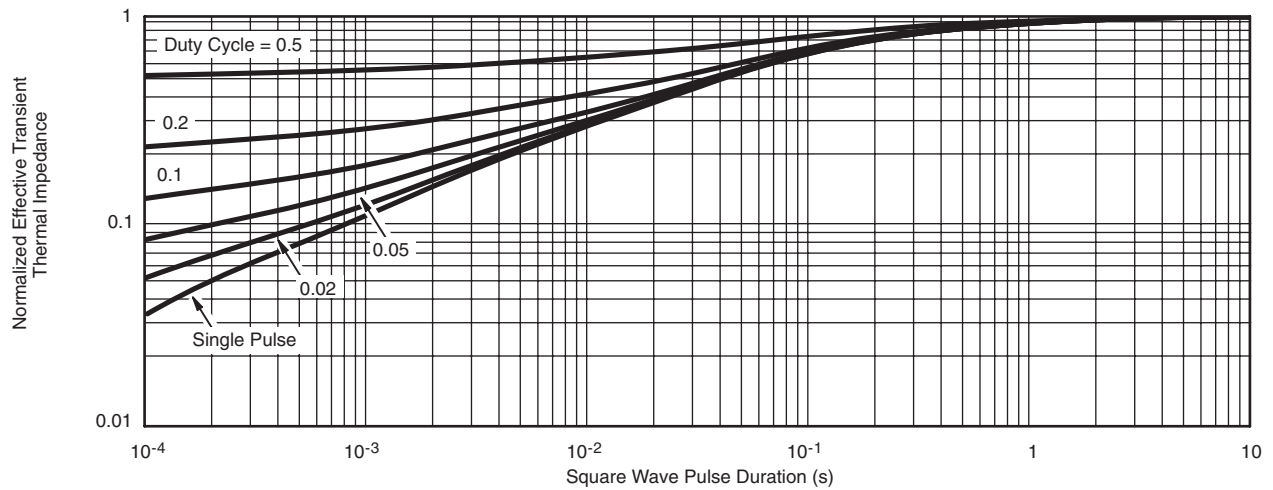

**Normalized Thermal Transient Impedance, Junction-to-Foot**

Vishay Siliconix maintains worldwide manufacturing capability. Products may be manufactured at one of several qualified locations. Reliability data for Silicon Technology and Package Reliability represent a composite of all qualified locations. For related documents such as package/tape drawings, part marking, and reliability data, see [www.vishay.com/ppg?68398](http://www.vishay.com/ppg?68398).



## Disclaimer

ALL PRODUCT, PRODUCT SPECIFICATIONS AND DATA ARE SUBJECT TO CHANGE WITHOUT NOTICE TO IMPROVE RELIABILITY, FUNCTION OR DESIGN OR OTHERWISE.

Vishay Intertechnology, Inc., its affiliates, agents, and employees, and all persons acting on its or their behalf (collectively, "Vishay"), disclaim any and all liability for any errors, inaccuracies or incompleteness contained in any datasheet or in any other disclosure relating to any product.

Vishay makes no warranty, representation or guarantee regarding the suitability of the products for any particular purpose or the continuing production of any product. To the maximum extent permitted by applicable law, Vishay disclaims (i) any and all liability arising out of the application or use of any product, (ii) any and all liability, including without limitation special, consequential or incidental damages, and (iii) any and all implied warranties, including warranties of fitness for particular purpose, non-infringement and merchantability.

Statements regarding the suitability of products for certain types of applications are based on Vishay's knowledge of typical requirements that are often placed on Vishay products in generic applications. Such statements are not binding statements about the suitability of products for a particular application. It is the customer's responsibility to validate that a particular product with the properties described in the product specification is suitable for use in a particular application. Parameters provided in datasheets and/or specifications may vary in different applications and performance may vary over time. All operating parameters, including typical parameters, must be validated for each customer application by the customer's technical experts. Product specifications do not expand or otherwise modify Vishay's terms and conditions of purchase, including but not limited to the warranty expressed therein.

Except as expressly indicated in writing, Vishay products are not designed for use in medical, life-saving, or life-sustaining applications or for any other application in which the failure of the Vishay product could result in personal injury or death. Customers using or selling Vishay products not expressly indicated for use in such applications do so at their own risk and agree to fully indemnify and hold Vishay and its distributors harmless from and against any and all claims, liabilities, expenses and damages arising or resulting in connection with such use or sale, including attorneys fees, even if such claim alleges that Vishay or its distributor was negligent regarding the design or manufacture of the part. Please contact authorized Vishay personnel to obtain written terms and conditions regarding products designed for such applications.

No license, express or implied, by estoppel or otherwise, to any intellectual property rights is granted by this document or by any conduct of Vishay. Product names and markings noted herein may be trademarks of their respective owners.