



### P-Channel JFETs

J174	SST174
J175	SST175
J176	SST176
J177	SST177

PRODUCT SUMMARY				
Part Number	V <sub>GS(off)</sub> (V)	r <sub>DS(on)</sub> Max (Ω)	I <sub>D(off)</sub> Typ (pA)	t <sub>ON</sub> Typ (ns)
J/SST174	5 to 10	85	-10	25
J/SST175	3 to 6	125	-10	25
J/SST176	1 to 4	250	-10	25
J/SST177	0.8 to 2.25	300	-10	25

#### FEATURES

- Low On-Resistance: J174 <85 Ω
- Fast Switching—t<sub>ON</sub>: 25 ns
- Low Leakage: -10 pA
- Low Capacitance: 5 pF
- Low Insertion Loss

#### BENEFITS

- Low Error Voltage
- High-Speed Analog Circuit Performance
- Negligible “Off-Error,” Excellent Accuracy
- Good Frequency Response
- Eliminates Additional Buffering

#### APPLICATIONS

- Analog Switches
- Choppers
- Sample-and-Hold
- Normally “On” Switches
- Current Limiters

#### DESCRIPTION

The J/SST174 series consists of p-channel analog switches designed to provide low on-resistance and fast switching. This series simplifies series-shunt switching applications when combined with the Siliconix J/SST111 series.

The TO-226AA (TO-92) plastic package provides a low-cost option, while the TO-236 (SOT-23) package provides surface-mount capability. Both the J and SST series are available in tape-and-reel for automated assembly (see Packaging Information).

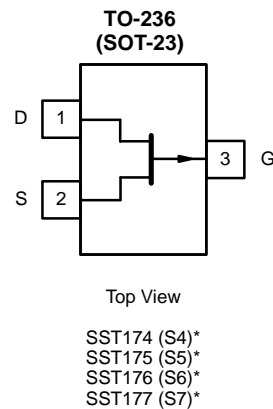
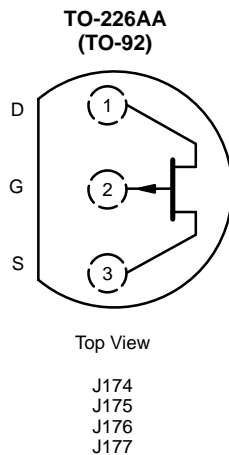

\*Marking Code for TO-236

For applications information see AN104.

### ABSOLUTE MAXIMUM RATINGS

Gate-Drain Voltage .....	30 V
Gate-Source Voltage .....	30 V
Gate Current .....	-50 mA
Storage Temperature .....	-55 to 150°C
Operating Junction Temperature .....	-55 to 150°C

Lead Temperature (1/16" from case for 10 sec.) .....	300°C
Power Dissipation <sup>a</sup> .....	350 mW

Notes

a. Derate 2.8 mW/°C above 25°C

SPECIFICATIONS FOR J/SST174 AND J/SST175 (T <sub>A</sub> = 25°C UNLESS OTHERWISE NOTED)								
Parameter	Symbol	Test Conditions	Typ <sup>a</sup>	Limits				Unit
				J/SST174		J/SST175		
				Min	Max	Min	Max	
<b>Static</b>								
Gate-Source Breakdown Voltage	V <sub>(BR)GSS</sub>	I <sub>G</sub> = 1 μA, V <sub>DS</sub> = 0 V	45	30		30		V
Gate-Source Cutoff Voltage	V <sub>GS(off)</sub>	V <sub>DS</sub> = -15 V, I <sub>D</sub> = -10 nA		5	10	3	6	
Saturation Drain Current <sup>b</sup>	I <sub>DSS</sub>	V <sub>DS</sub> = -15 V, V <sub>GS</sub> = 0 V		-20	-135	-7	-70	mA
Gate Reverse Current	I <sub>GSS</sub>	V <sub>GS</sub> = 20 V, V <sub>DS</sub> = 0 V T <sub>A</sub> = 125°C	0.01 5		1		1	nA
Gate Operating Current	I <sub>G</sub>	V <sub>DG</sub> = -15 V, I <sub>D</sub> = -1 mA	0.01					
Drain Cutoff Current	I <sub>D(off)</sub>	V <sub>DS</sub> = -15 V, V <sub>GS</sub> = 10 V T <sub>A</sub> = 125°C	-0.01 -5		-1		-1	
Drain-Source On-Resistance	r <sub>DS(on)</sub>	V <sub>GS</sub> = 0 V, V <sub>DS</sub> = -0.1 V			85		125	Ω
Gate-Source Forward Voltage	V <sub>GS(F)</sub>	I <sub>G</sub> = -1 mA, V <sub>DS</sub> = 0 V	-0.7					V
<b>Dynamic</b>								
Common-Source Forward Transconductance	g <sub>fs</sub>	V <sub>DS</sub> = -15 V, I <sub>D</sub> = -1 mA f = 1 kHz	4.5					mS
Common-Source Output Conductance	g <sub>os</sub>		20					μS
Drain-Source On-Resistance	r <sub>ds(on)</sub>	V <sub>GS</sub> = 0 V, I <sub>D</sub> = 0 mA, f = 1 kHz			85		125	Ω
Common-Source Input Capacitance	C <sub>iss</sub>	V <sub>DS</sub> = 0 V, V <sub>GS</sub> = 0 V, f = 1 MHz	20					pF
Common-Source Reverse Transfer Capacitance	C <sub>rss</sub>	V <sub>DS</sub> = 0 V, V <sub>GS</sub> = 10 V f = 1 MHz	5					
Equivalent Input Noise Voltage	e <sub>n</sub>	V <sub>DG</sub> = -10 V, I <sub>D</sub> = -1 mA f = 1 kHz	20					nV/ √Hz
<b>Switching</b>								
Turn-On Time	t <sub>d(on)</sub>	V <sub>GS(L)</sub> = 0 V, V <sub>GS(H)</sub> = 10 V See Switching Circuit	10					ns
	t <sub>r</sub>		15					
Turn-Off Time	t <sub>d(off)</sub>		10					
	t <sub>f</sub>		20					

Notes

- a. Typical values are for DESIGN AID ONLY, not guaranteed nor subject to production testing.  
 b. Pulse test: PW ≤ 300 μs duty cycle ≤ 3%.

PSCIA



SPECIFICATIONS FOR J/SST176 AND J/SST177 (T <sub>A</sub> = 25 °C UNLESS OTHERWISE NOTED)								
Parameter	Symbol	Test Conditions	Typ <sup>a</sup>	Limits				Unit
				J/SST176		J/SST177		
				Min	Max	Min	Max	
<b>Static</b>								
Gate-Source Breakdown Voltage	V <sub>(BR)GSS</sub>	I <sub>G</sub> = 1 μA, V <sub>DS</sub> = 0 V	45	30		30		V
Gate-Source Cutoff Voltage	V <sub>GS(off)</sub>	V <sub>DS</sub> = -15 V, I <sub>D</sub> = -10 nA		1	4	0.8	2.25	
Saturation Drain Current <sup>b</sup>	I <sub>DSS</sub>	V <sub>DS</sub> = -15 V, V <sub>GS</sub> = 0 V		-2	-35	-1.5	-20	mA
Gate Reverse Current	I <sub>GSS</sub>	V <sub>GS</sub> = 20 V, V <sub>DS</sub> = 0 V	0.01		1		1	nA
		T <sub>A</sub> = 125 °C	5					
Gate Operating Current	I <sub>G</sub>	V <sub>DG</sub> = -15 V, I <sub>D</sub> = -1 mA	0.01					nA
Drain Cutoff Current	I <sub>D(off)</sub>	V <sub>DS</sub> = -15 V, V <sub>GS</sub> = 10 V	-0.01		-1		-1	
		T <sub>A</sub> = 125 °C	-5					
Drain-Source On-Resistance	r <sub>DS(on)</sub>	V <sub>GS</sub> = 0 V, V <sub>DS</sub> = -0.1 V			250		300	Ω
Gate-Source Forward Voltage	V <sub>GS(F)</sub>	I <sub>G</sub> = -1 mA, V <sub>DS</sub> = 0 V	-0.7					V
<b>Dynamic</b>								
Common-Source Forward Transconductance	g <sub>fs</sub>	V <sub>DS</sub> = -15 V, I <sub>D</sub> = -1 mA f = 1 kHz	4.5					mS
Common-Source Output Conductance	g <sub>os</sub>		20					μS
Drain-Source On-Resistance	r <sub>ds(on)</sub>	V <sub>GS</sub> = 0 V, I <sub>D</sub> = 0 mA, f = 1 kHz			250		300	Ω
Common-Source Input Capacitance	C <sub>iss</sub>	V <sub>DS</sub> = 0 V, V <sub>GS</sub> = 0 V, f = 1 MHz	20					pF
Common-Source Reverse Transfer Capacitance	C <sub>rss</sub>	V <sub>DS</sub> = 0 V, V <sub>GS</sub> = 10 V f = 1 MHz	5					
Equivalent Input Noise Voltage	e <sub>n</sub>	V <sub>DG</sub> = -10 V, I <sub>D</sub> = -1 mA f = 1 kHz	20					nV/ √Hz
<b>Switching</b>								
Turn-On Time	t <sub>d(on)</sub>	V <sub>GS(L)</sub> = 0 V, V <sub>GS(H)</sub> = 10 V See Switching Circuit	10					ns
	t <sub>r</sub>		15					
Turn-Off Time	t <sub>d(off)</sub>		10					
	t <sub>f</sub>		20					

Notes

- a. Typical values are for DESIGN AID ONLY, not guaranteed nor subject to production testing.
- b. Pulse test: PW ≤ 300 μs duty cycle ≤ 3%.

PSCIA

### TYPICAL CHARACTERISTICS ( $T_A = 25^\circ\text{C}$ UNLESS OTHERWISE NOTED)

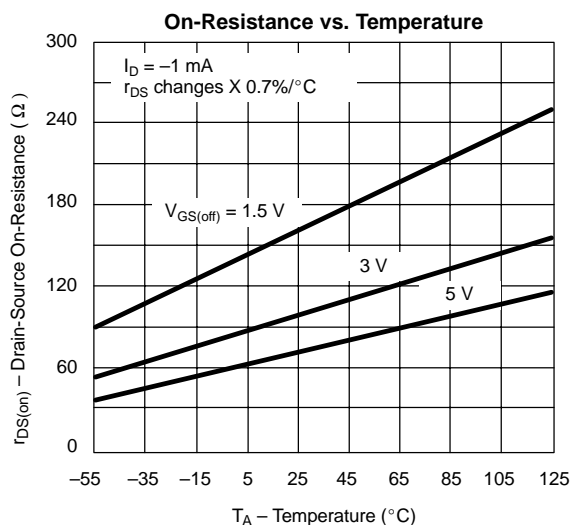
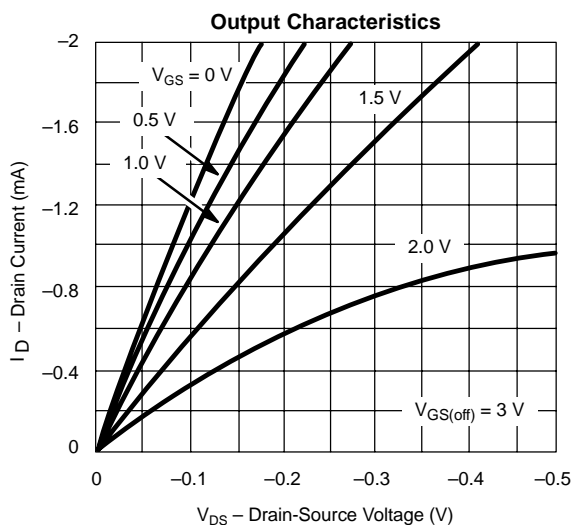
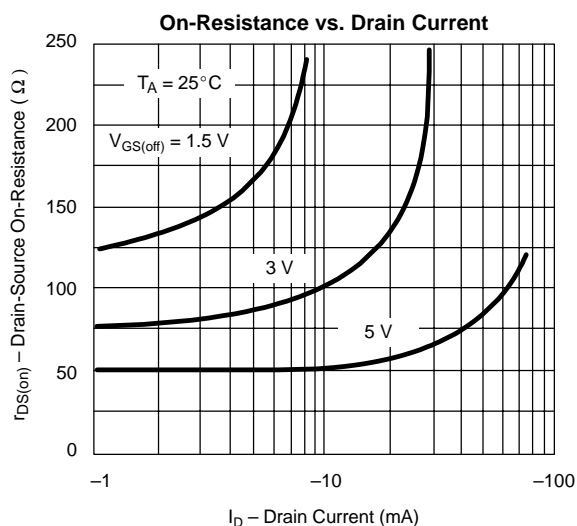
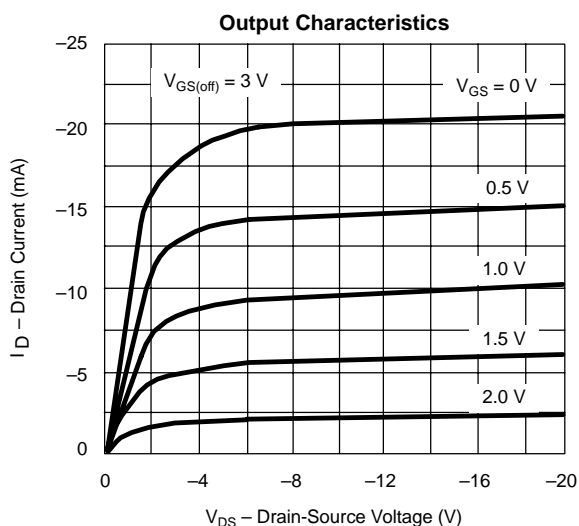
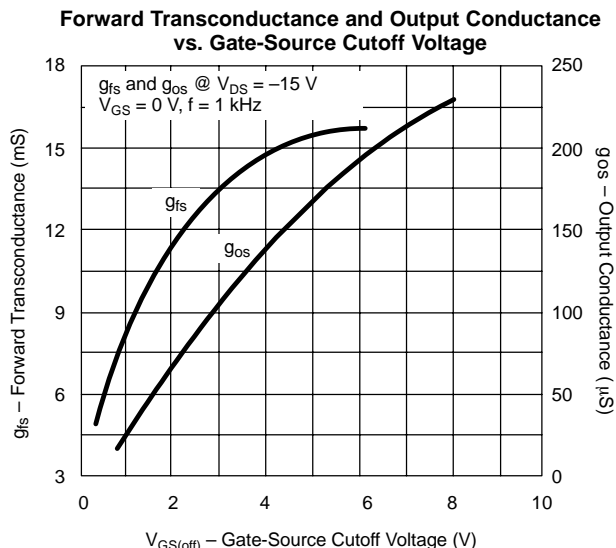
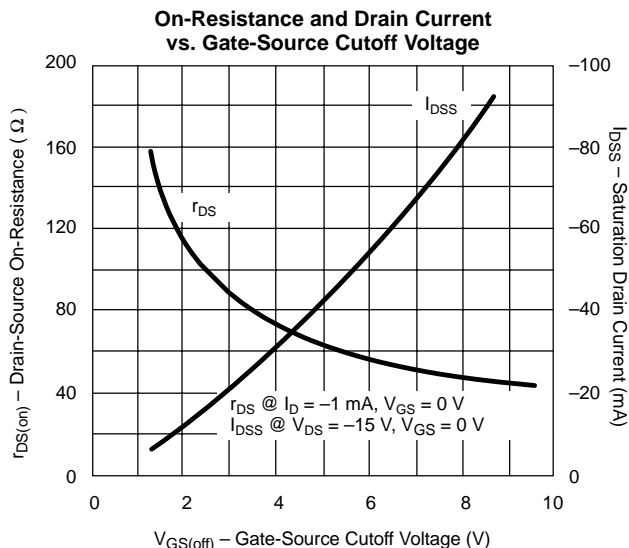



**TYPICAL CHARACTERISTICS (T<sub>A</sub> = 25°C UNLESS OTHERWISE NOTED)**

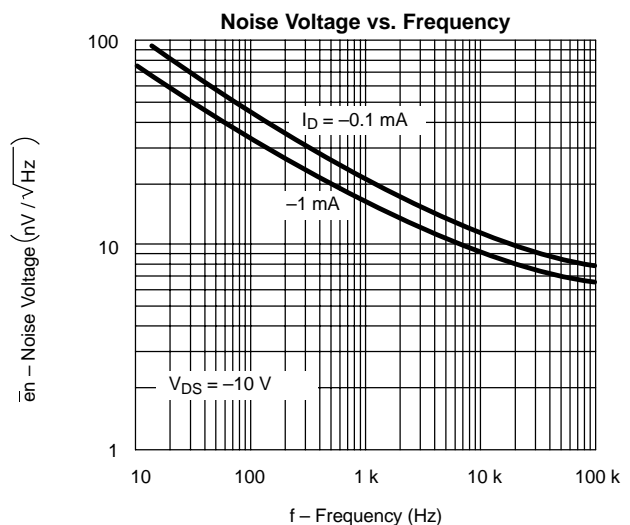
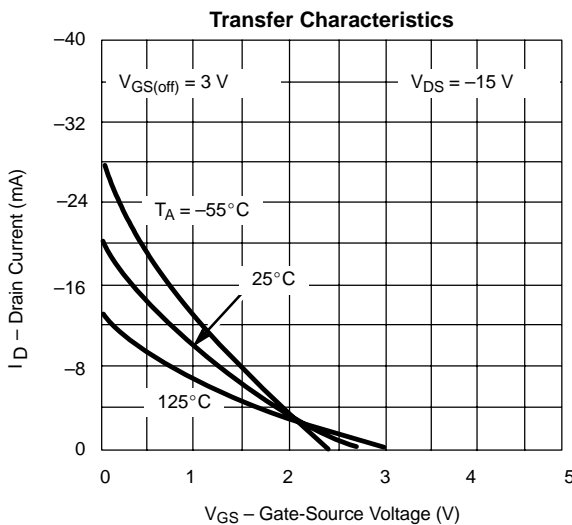
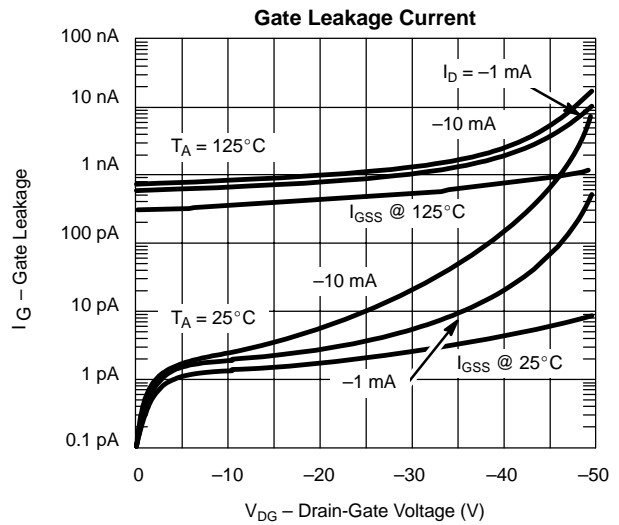
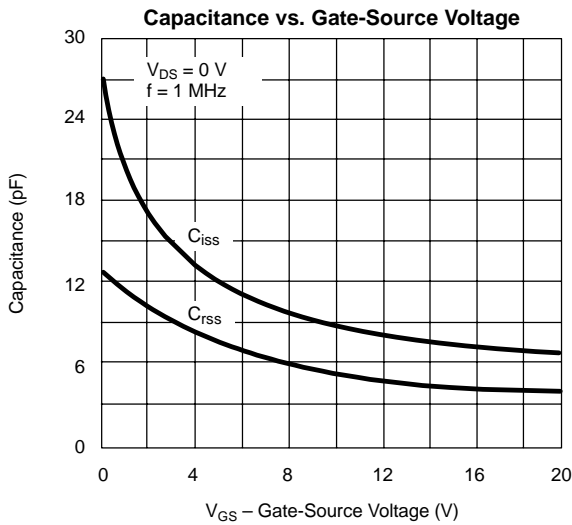
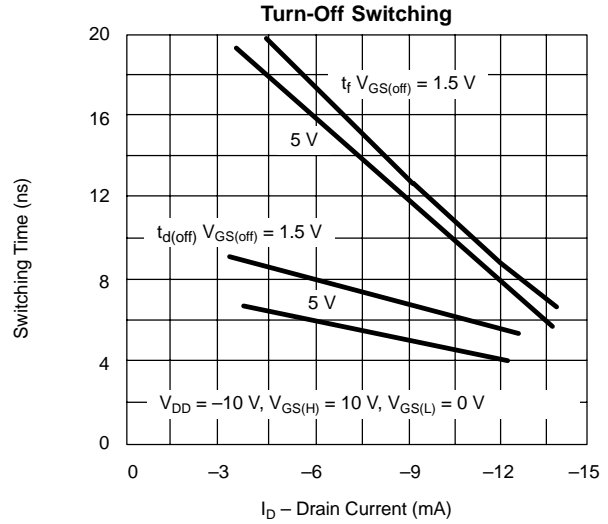
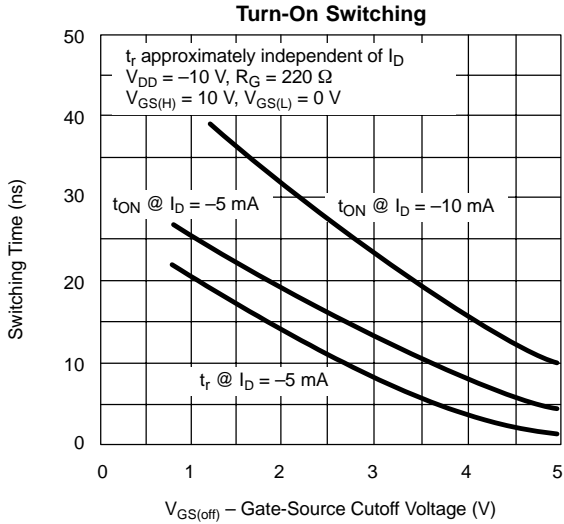

SWITCHING TIME TEST CIRCUIT				
	174	175	176	177
$V_{DD}$	-10 V	-6 V	-6 V	-6 V
$V_{GG}$	20 V	12 V	8 V	5 V
$R_L^*$	560 $\Omega$	750 $\Omega$	1800 $\Omega$	5600 $\Omega$
$R_G^*$	100 $\Omega$	220 $\Omega$	390 $\Omega$	390 $\Omega$
$I_{D(on)}$	-15 mA	-7 mA	-3 mA	-1 mA

\*Non-inductive

### INPUT PULSE

Rise Time < 1 ns  
 Fall Time < 1 ns  
 Pulse Width 100 ns  
 PRF 1 MHz

### SAMPLING SCOPE

Rise Time 0.4 ns  
 Input Resistance 10 M $\Omega$   
 Input Capacitance 1.5 pF

See Typical Characteristics curves for changes.

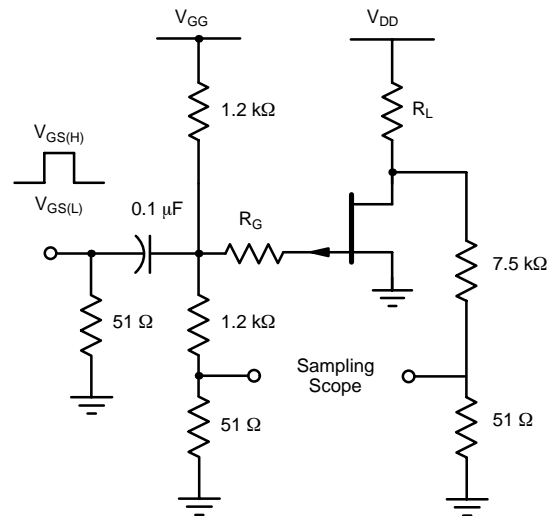



## Notice

Specifications of the products displayed herein are subject to change without notice. Vishay Intertechnology, Inc., or anyone on its behalf, assumes no responsibility or liability for any errors or inaccuracies.

Information contained herein is intended to provide a product description only. No license, express or implied, by estoppel or otherwise, to any intellectual property rights is granted by this document. Except as provided in Vishay's terms and conditions of sale for such products, Vishay assumes no liability whatsoever, and disclaims any express or implied warranty, relating to sale and/or use of Vishay products including liability or warranties relating to fitness for a particular purpose, merchantability, or infringement of any patent, copyright, or other intellectual property right.

The products shown herein are not designed for use in medical, life-saving, or life-sustaining applications. Customers using or selling these products for use in such applications do so at their own risk and agree to fully indemnify Vishay for any damages resulting from such improper use or sale.