

GT50J325

High Power Switching Applications
Fast Switching Applications

- The 4th generation
- Enhancement-mode
- Fast switching (FS): Operating frequency up to 50 kHz (reference)
 - High speed: $t_f = 0.05 \mu s$ (typ.)
 - Low switching loss: $E_{on} = 1.30 \text{ mJ}$ (typ.)
: $E_{off} = 1.34 \text{ mJ}$ (typ.)
- Low saturation Voltage: $V_{CE(sat)} = 2.0 \text{ V}$ (typ.)
- FRD included between emitter and collector

Maximum Ratings (Ta = 25°C)

Characteristics		Symbol	Rating	Unit
Collector-emitter voltage		V_{CES}	600	V
Gate-emitter voltage		V_{GES}	±20	V
Collector current	DC	I_C	50	A
	1 ms	I_{CP}	100	
Emitter-collector forward current	DC	I_F	50	A
	1 ms	I_{FM}	100	
Collector power dissipation (Tc = 25°C)		P_C	240	W
Junction temperature		T_j	150	°C
Storage temperature range		T_{stg}	-55 to 150	°C

Thermal Characteristics

Characteristics	Symbol	Max	Unit
Thermal resistance (IGBT)	$R_{th(j-c)}$	0.521	°C/W
Thermal resistance (diode)	$R_{th(j-c)}$	2.30	°C/W

Equivalent Circuit

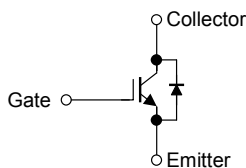

Unit: mm

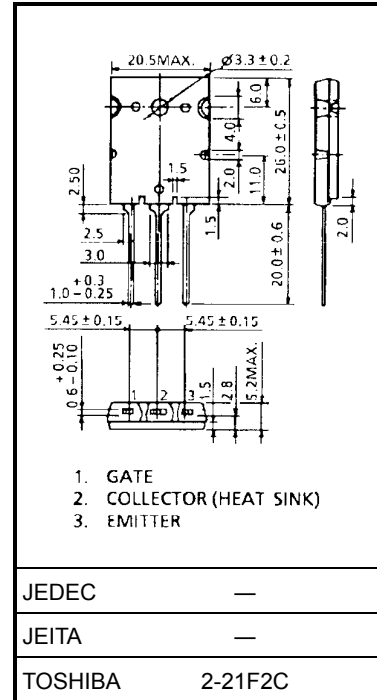

Weight: 9.75 g

Electrical Characteristics (Ta = 25°C)

Characteristics		Symbol	Test Condition	Min	Typ.	Max	Unit
Gate leakage current		I_{GES}	$V_{GE} = \pm 20\text{ V}, V_{CE} = 0$	—	—	± 500	nA
Collector cut-off current		I_{CES}	$V_{CE} = 600\text{ V}, V_{GE} = 0$	—	—	1.0	mA
Gate-emitter cut-off voltage		$V_{GE(OFF)}$	$I_C = 5\text{ mA}, V_{CE} = 5\text{ V}$	3.5	—	6.5	V
Collector-emitter saturation voltage		$V_{CE(sat)}$	$I_C = 50\text{ A}, V_{GE} = 15\text{ V}$	—	2.0	2.45	V
Input capacitance		C_{ies}	$V_{CE} = 10\text{ V}, V_{GE} = 0, f = 1\text{ MHz}$	—	7900	—	pF
Switching time	Turn-on delay time	$t_{d(on)}$	Inductive load $V_{CC} = 300\text{ V}, I_C = 50\text{ A}$ $V_{GG} = +15\text{ V}, R_G = 13\ \Omega$	—	0.09	—	μs
	Rise time	t_r		—	0.07	—	
	Turn-on time	t_{on}		—	0.24	—	
	Turn-off delay time	$t_{d(off)}$		—	0.30	—	
	Fall time	t_f		—	0.05	—	
	Turn-off time	t_{off}		—	0.43	—	
Switching loss	Turn-on switching loss	E_{on}	(Note 1)	—	1.30	—	mJ
	Turn-off switching loss	E_{off}	(Note 2)	—	1.34	—	
Peak forward voltage		V_F	$I_F = 50\text{ A}, V_{GE} = 0$	—	—	4.2	V
Reverse recovery time		t_{rr}	$I_F = 50\text{ A}, di/dt = -100\text{ A}/\mu\text{s}$	—	65	—	ns

Note 1: Switching time measurement circuit and input/output waveforms

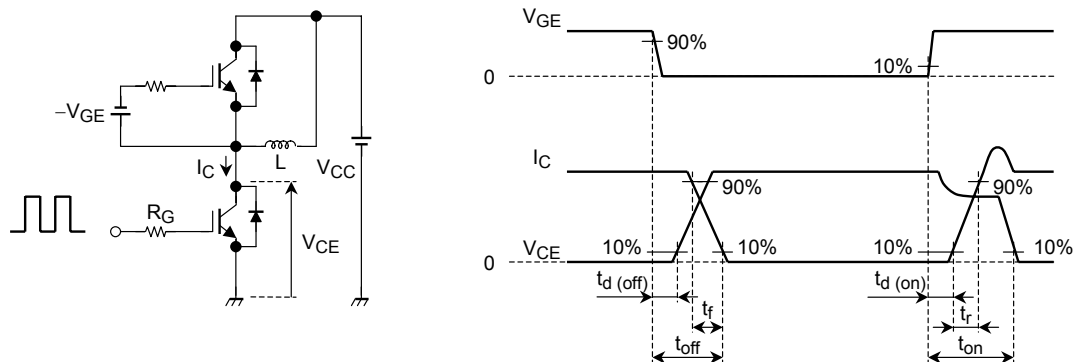

Note 2: Switching loss measurement waveforms

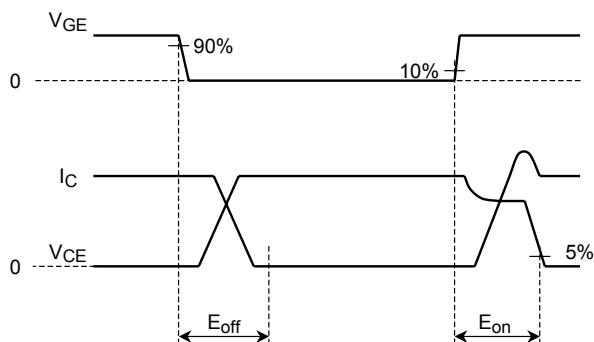

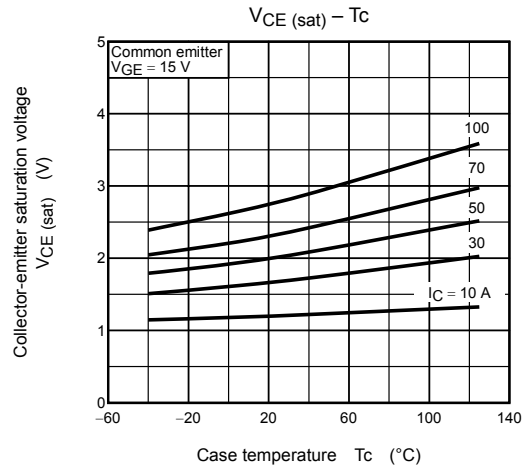
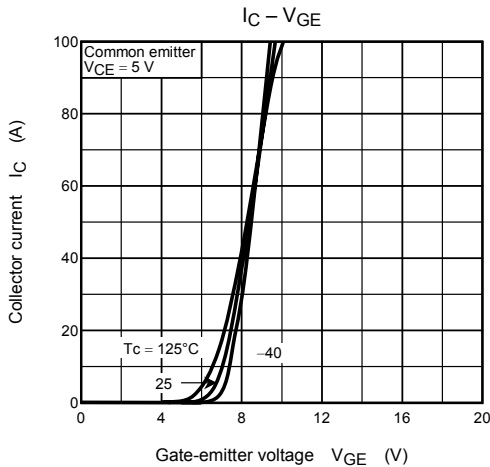
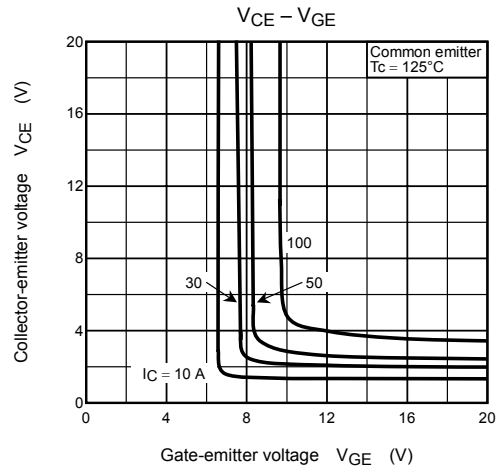
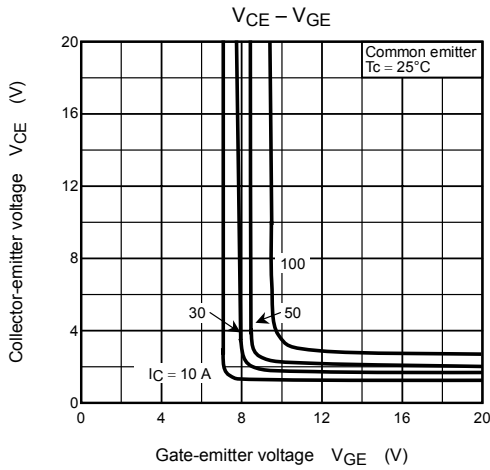
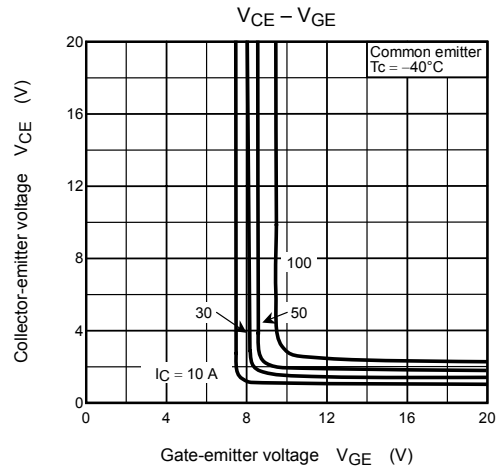
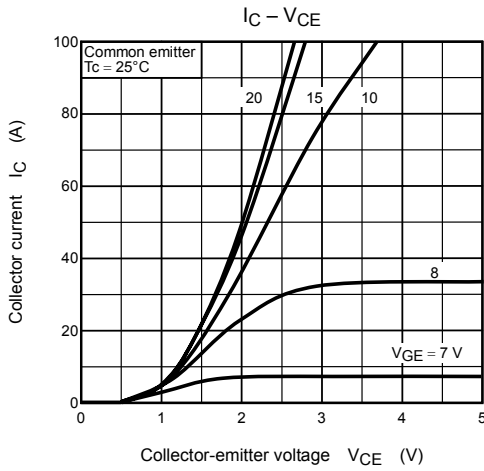

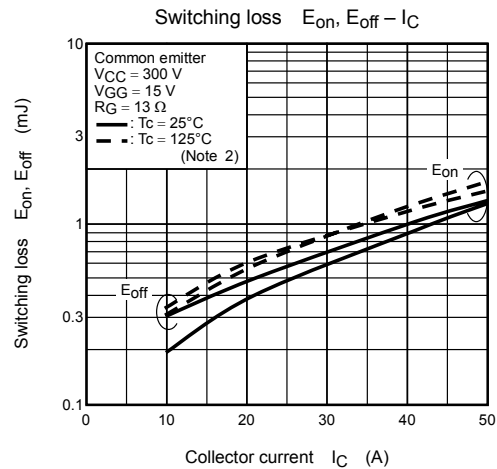
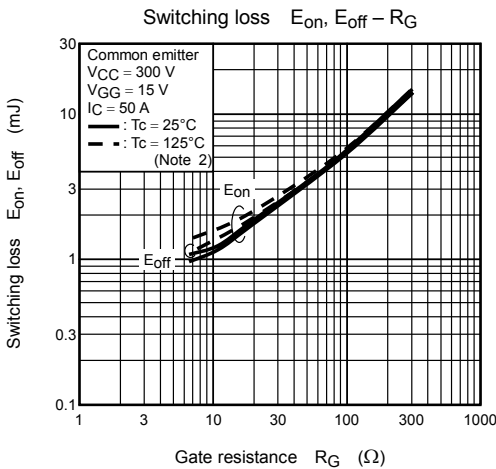
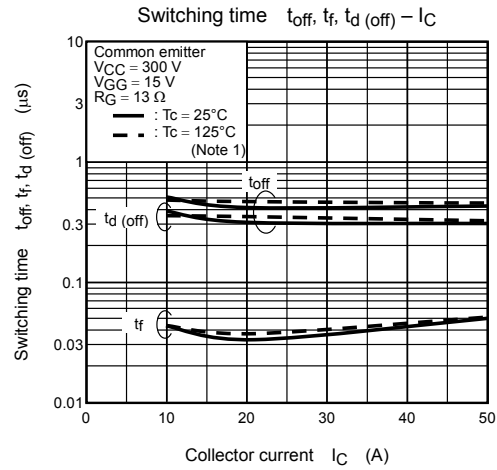
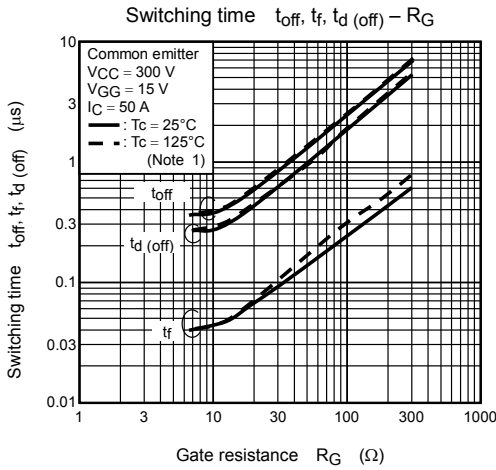
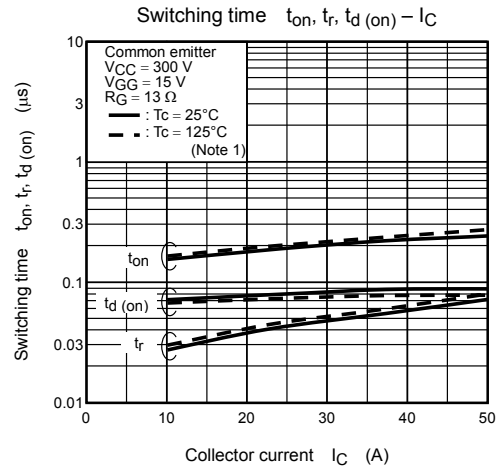
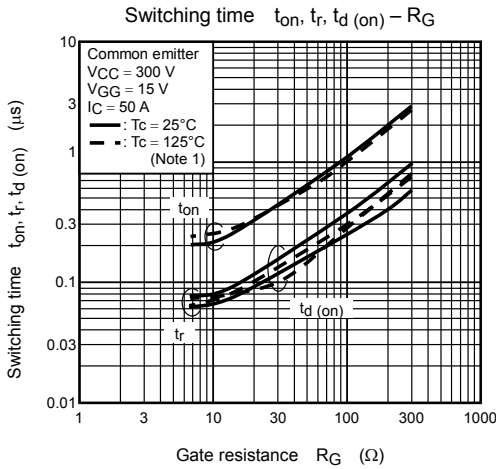

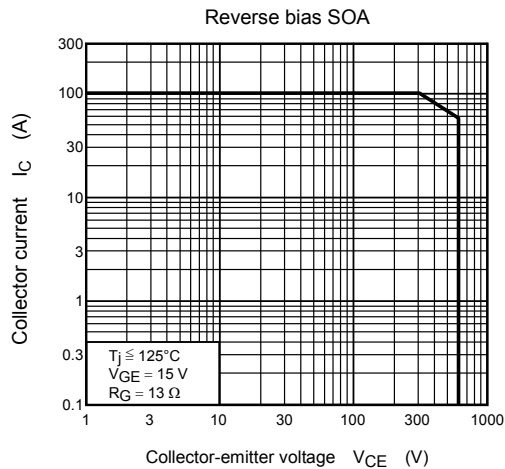
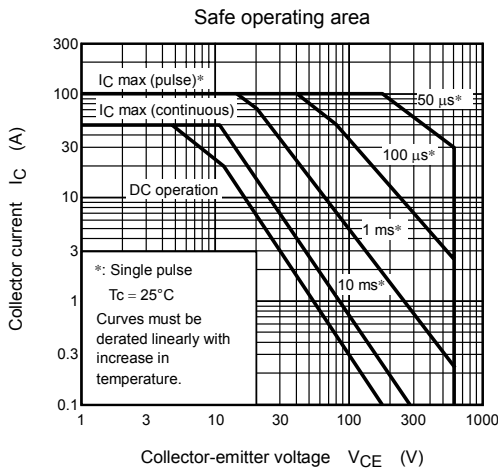
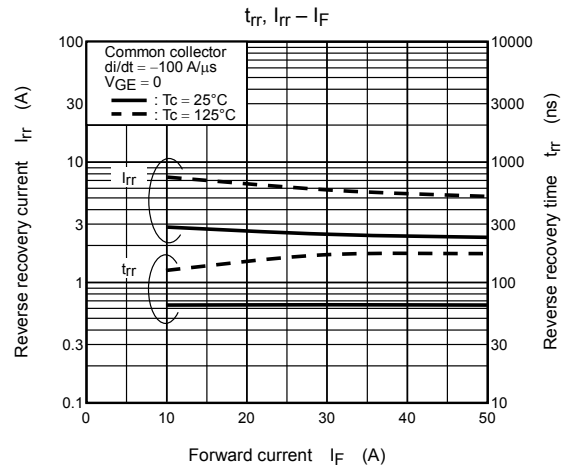
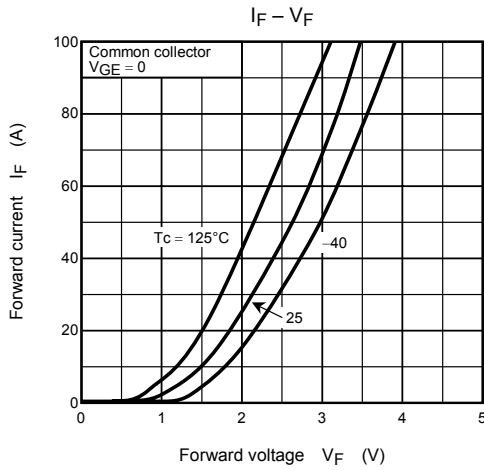
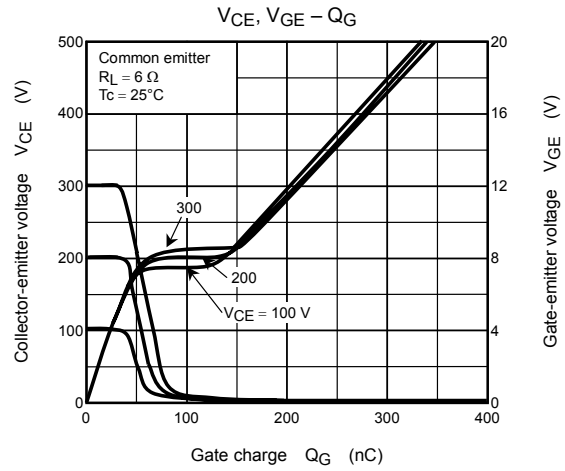
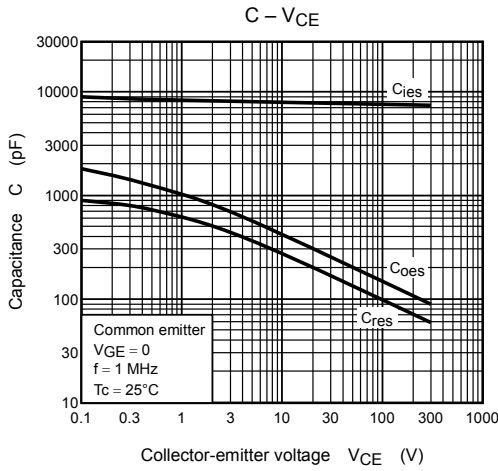

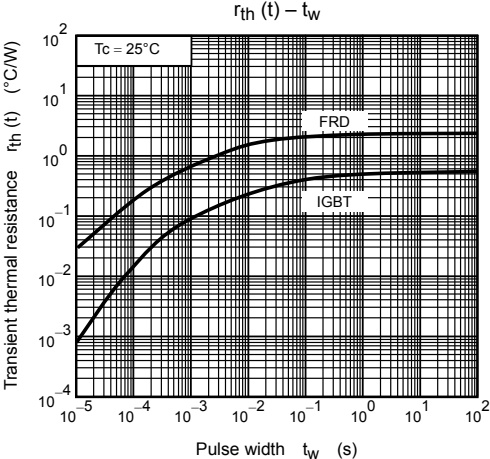

RESTRICTIONS ON PRODUCT USE

000707EAA

- TOSHIBA is continually working to improve the quality and reliability of its products. Nevertheless, semiconductor devices in general can malfunction or fail due to their inherent electrical sensitivity and vulnerability to physical stress. It is the responsibility of the buyer, when utilizing TOSHIBA products, to comply with the standards of safety in making a safe design for the entire system, and to avoid situations in which a malfunction or failure of such TOSHIBA products could cause loss of human life, bodily injury or damage to property.
In developing your designs, please ensure that TOSHIBA products are used within specified operating ranges as set forth in the most recent TOSHIBA products specifications. Also, please keep in mind the precautions and conditions set forth in the "Handling Guide for Semiconductor Devices," or "TOSHIBA Semiconductor Reliability Handbook" etc..
- The TOSHIBA products listed in this document are intended for usage in general electronics applications (computer, personal equipment, office equipment, measuring equipment, industrial robotics, domestic appliances, etc.). These TOSHIBA products are neither intended nor warranted for usage in equipment that requires extraordinarily high quality and/or reliability or a malfunction or failure of which may cause loss of human life or bodily injury ("Unintended Usage"). Unintended Usage include atomic energy control instruments, airplane or spaceship instruments, transportation instruments, traffic signal instruments, combustion control instruments, medical instruments, all types of safety devices, etc.. Unintended Usage of TOSHIBA products listed in this document shall be made at the customer's own risk.
- The information contained herein is presented only as a guide for the applications of our products. No responsibility is assumed by TOSHIBA CORPORATION for any infringements of intellectual property or other rights of the third parties which may result from its use. No license is granted by implication or otherwise under any intellectual property or other rights of TOSHIBA CORPORATION or others.
- The information contained herein is subject to change without notice.

This datasheet has been download from:

www.datasheetcatalog.com

Datasheets for electronics components.