

### IGBT MODULE (U series) 1200V / 25A / PIM



#### ■ Features

- Low  $V_{CE(sat)}$
- Compact Package
- P.C. Board Mount Module
- Converter Diode Bridge Dynamic Brake Circuit

#### ■ Applications

- Inverter for Motoe Drive
- AC and DC Servo Drive Amplifier
- Uninterruptible Power Supply

#### ■ Maximum ratings and characteristics

● Absolute maximum ratings ( $T_c=25^\circ\text{C}$  unless otherwise specified)

Item	Symbol	Condition	Rating	Unit		
Inverter	Collector-Emitter voltage	$V_{CES}$	1200	V		
	Gate-Emitter voltage	$V_{GES}$	$\pm 20$	V		
	Collector current	$I_c$	Continuous	$T_c=25^\circ\text{C}$	25	A
				$T_c=80^\circ\text{C}$	15	
		$I_{cP}$	1ms	$T_c=25^\circ\text{C}$	50	
				$T_c=80^\circ\text{C}$	30	
	$-I_c$			25		
$-I_c$ pulse	1ms		50			
Collector power dissipation	$P_c$	1 device	115	W		
Brake	Collector-Emitter voltage	$V_{CES}$	1200	V		
	Gate-Emitter voltage	$V_{GES}$	$\pm 20$	V		
	Collector current	$I_c$	Continuous	$T_c=25^\circ\text{C}$	25	A
				$T_c=80^\circ\text{C}$	15	
		$I_{cP}$	1ms	$T_c=25^\circ\text{C}$	50	
				$T_c=80^\circ\text{C}$	30	
	Collector power dissipation	$P_c$	1 device	115	W	
Repetitive peak reverse voltage	$V_{RRM}$		1200	V		
Converter	Repetitive peak reverse voltage	$V_{RRM}$	1600	V		
	Average output current	$I_D$	50Hz/60Hz sine wave	25	A	
	Surge current (Non-Repetitive)	$I_{FSM}$	$T_j=150^\circ\text{C}$ , 10ms	260	A	
	$I^2t$ (Non-Repetitive)	$Pt$	half sine wave	338	$\text{A}^2\text{s}$	
Operating junction temperature	$T_j$		+150	$^\circ\text{C}$		
Storage temperature	$T_{stg}$		-40 to +125	$^\circ\text{C}$		
Isolation voltage	between terminal and copper base *2	$V_{iso}$	AC : 1 minute	AC 2500	V	
	between thermistor and others *3			AC 2500	V	
Mounting screw torque			3.5 *1	N·m		

\*1 Recommendable value : 2.5 to 3.5 N·m (M5)

\*2 All terminals should be connected together when isolation test will be done.

\*3 Two thermistor terminals should be connected together, each other terminals should be connected together and shorted to base plate when isolation test will be done.

## ● Electrical characteristics (Tj=25°C unless otherwise specified)

Item	Symbol	Condition	Characteristics			Unit		
			Min.	Typ.	Max.			
Inverter	Zero gate voltage collector current	ICES	VCE=1200V, VGE=0V		-	1.0	mA	
	Gate-Emitter leakage current	IGES	VCE=0V, VGE=±20V		-	200	nA	
	Gate-Emitter threshold voltage	VGE(th)	VCE=20V, Ic=25mA		4.5	6.5	8.5	V
	Collector-Emitter saturation voltage	VCE(sat) (terminal)	VGE=15V Ic=25A	Tj=25°C	-	2.30	2.80	V
				Tj=125°C	-	2.75	-	
		VCE(sat) (chip)	Tj=25°C	-	2.10	2.60		
			Tj=125°C	-	2.55	-		
	Input capacitance	Cies	VGE=0V, VCE=10V, f=1MHz		-	2	-	nF
	Turn-on time	ton	VCC=600V		-	0.41	1.20	µs
		tr	Ic=25A		-	0.28	0.60	
		tr(i)	VGE=±15V		-	0.03	-	
	Turn-off time	toff	RG= 68 Ω		-	0.37	1.00	µs
		tf			-	0.07	0.30	
	Forward on voltage	VF (terminal)	VGE= 0 V IF=25A	Tj=25°C	-	2.95	3.55	V
Tj=125°C				-	2.55	-		
VF (chip)		Tj=25°C	-	2.75	3.35			
		Tj=125°C	-	2.35	-			
Reverse recovery time	trr	IF=25A		-	-	0.35	µs	
Brake	Zero gate voltage collector current	ICES	VCE=1200V, VGE=0V		-	1.0	mA	
	Gate-Emitter leakage current	IGES	VCE=0V, VGE=±20V		-	200	nA	
	Collector-Emitter saturation voltage	VCE(sat) (terminal)	Ic=25A VGE=15V	Tj=25°C	-	2.30	2.80	V
				Tj=125°C	-	2.75	-	
		VCE(sat) (chip)	Tj=25°C	-	2.10	2.60		
			Tj=125°C	-	2.55	-		
	Turn-on time	ton	VCC=600V		-	0.41	1.20	µs
		tr	Ic=25A		-	0.28	0.60	
	Turn-off time	toff	VGE=±15V		-	0.37	1.00	µs
		tf	RG= 68 Ω		-	0.07	0.30	
	Reverse current	IRRM	VR=1200V		-	-	1.0	mA
	Forward on voltage	VFM	IF=25 A VGE=0V	terminal	-	1.20	1.50	V
				chip	-	1.10	-	
	Reverse current	IRRM	VR=1600V		-	-	1.0	mA
Thermistor	Resistance	R	T=25°C	-	5000	-	Ω	
			T=100°C	465	495	520		
	B value	B	T=25/50°C	3305	3375	3450	K	

## ● Thermal resistance Characteristics

Item	Symbol	Condition	Characteristics			Unit
			Min.	Typ.	Max.	
Thermal resistance ( 1 device )	Rth(j-c)	Inverter IGBT	-	-	1.07	°C/W
		Inverter FWD	-	-	1.58	
		Brake IGBT	-	-	1.07	
		Converter Diode	-	-	0.90	
Contact thermal resistance *	Rth(c-f)	With thermal compound	-	0.05	-	

\* This is the value which is defined mounting on the additional cooling fin with thermal compound

## ■ Equivalent Circuit Schematic

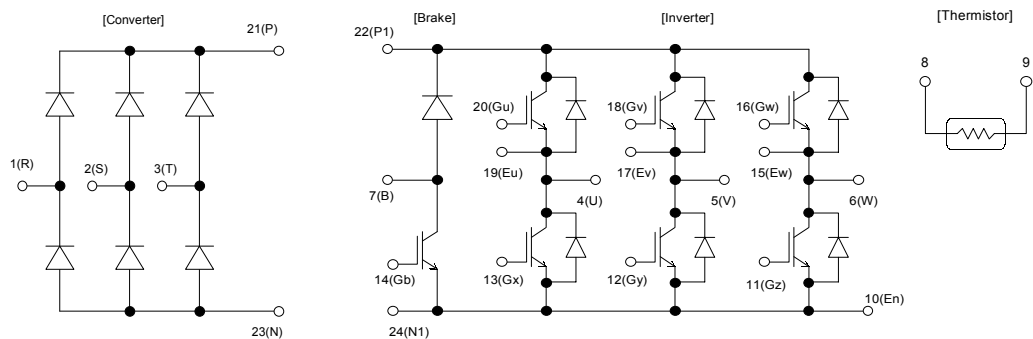

■ Characteristics (Representative)

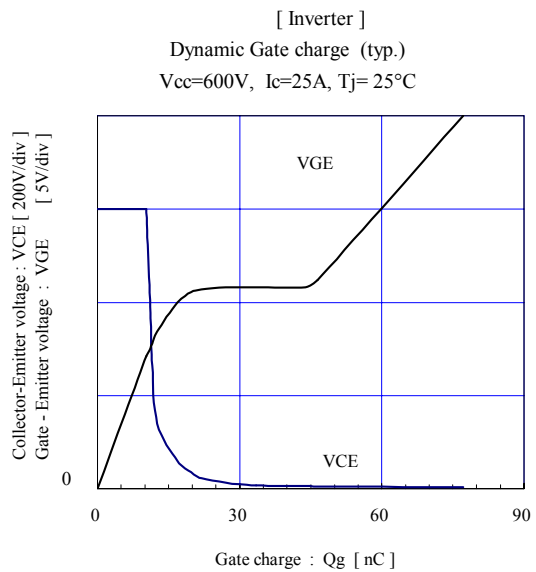
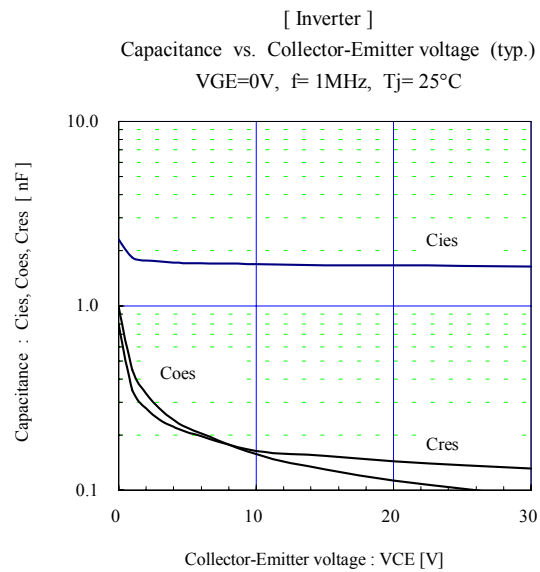
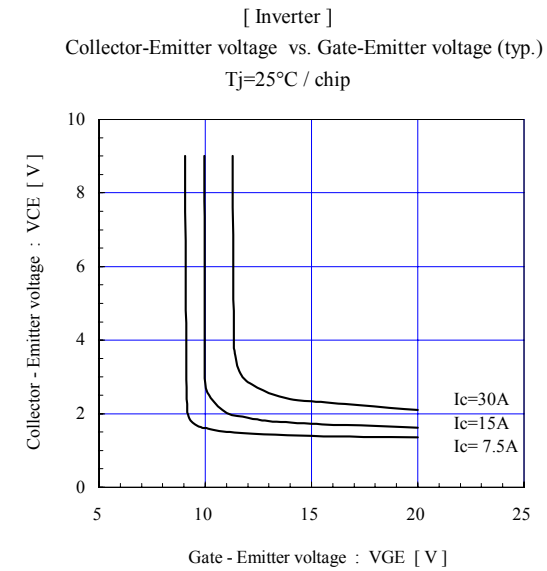
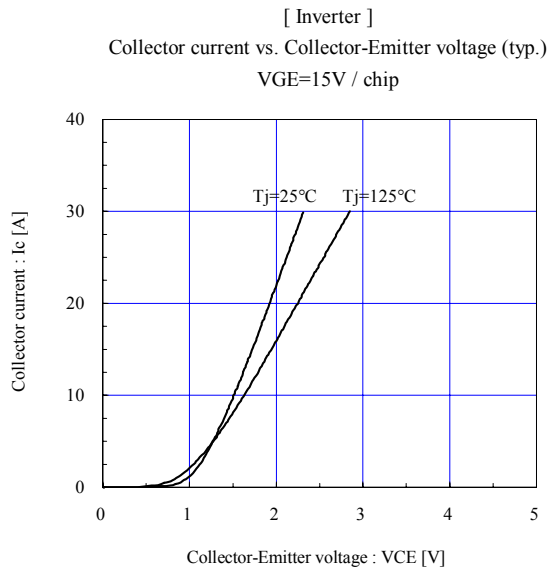
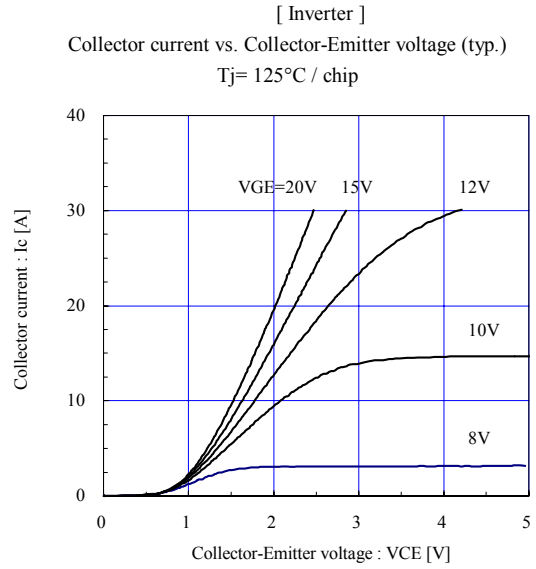
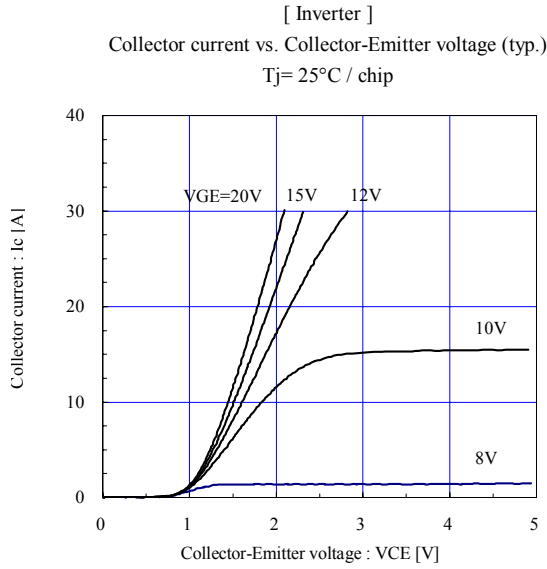

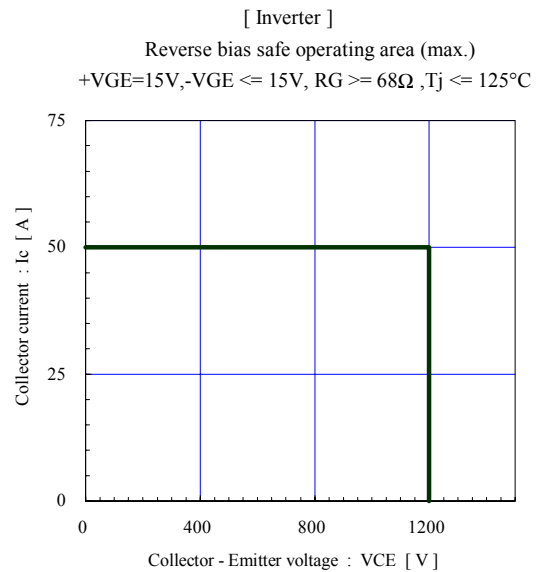
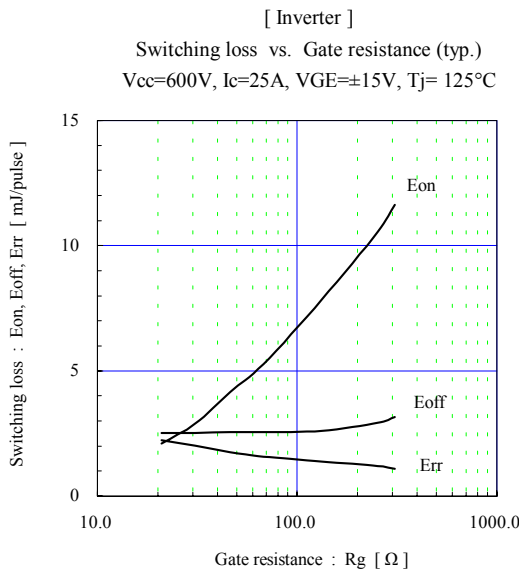
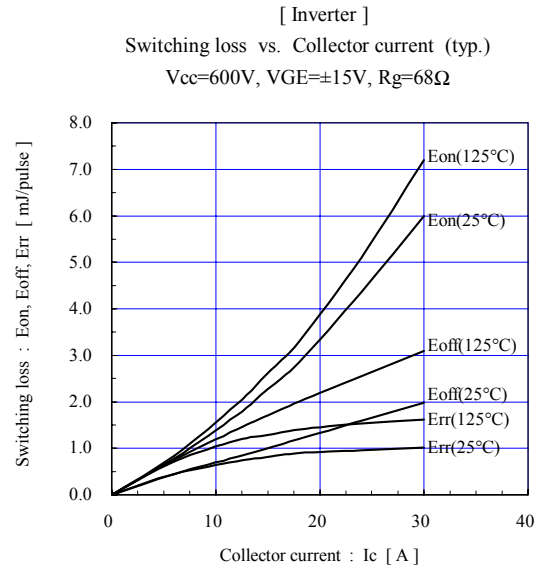
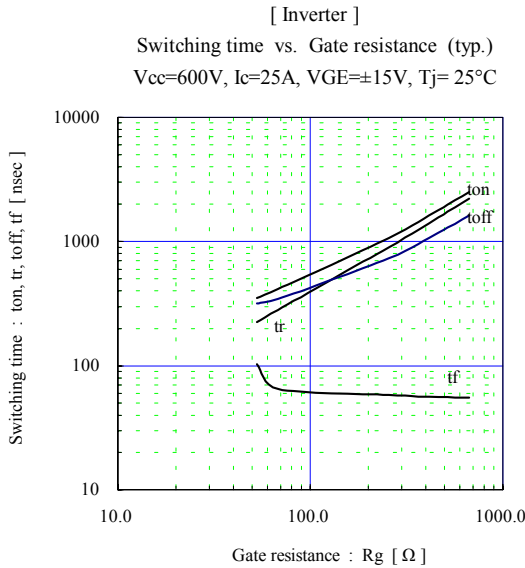
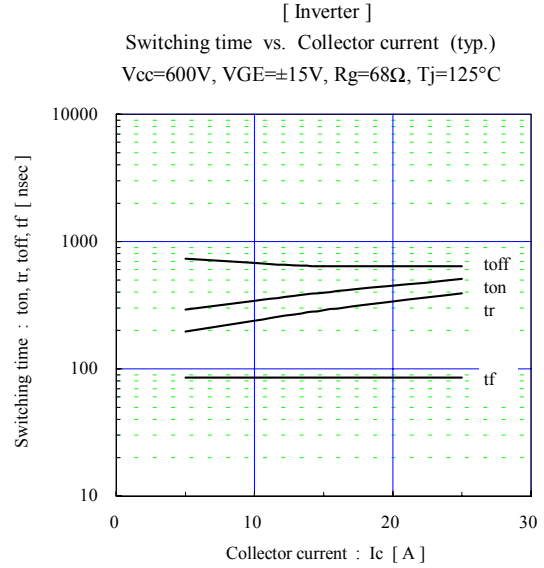
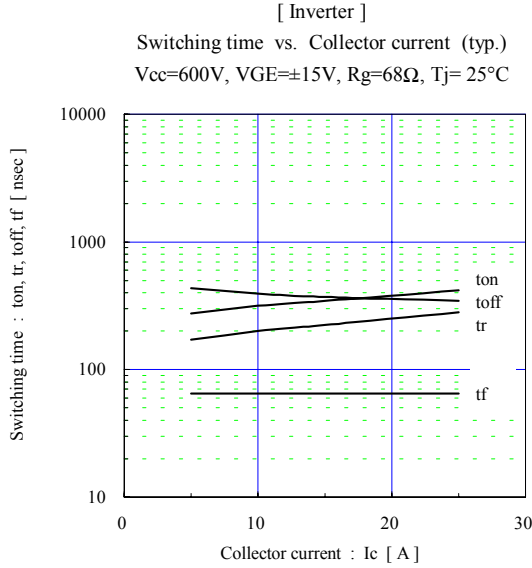

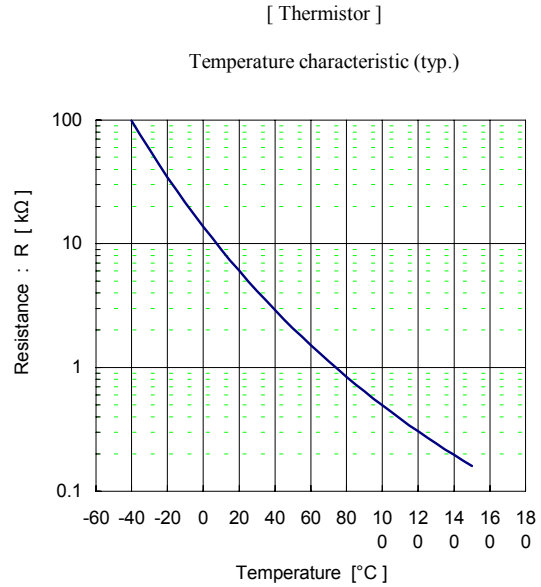
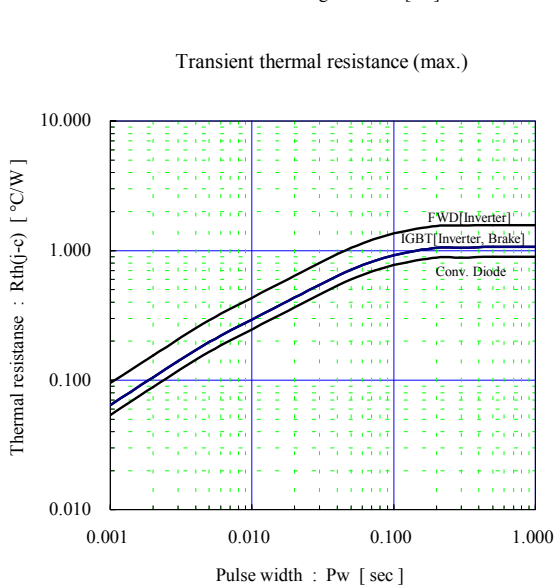
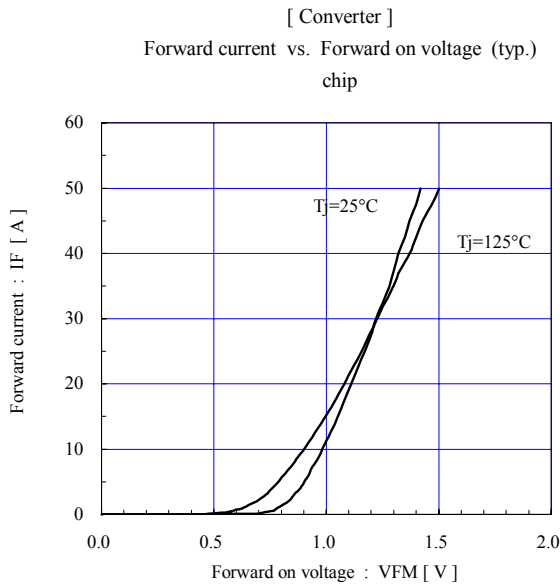
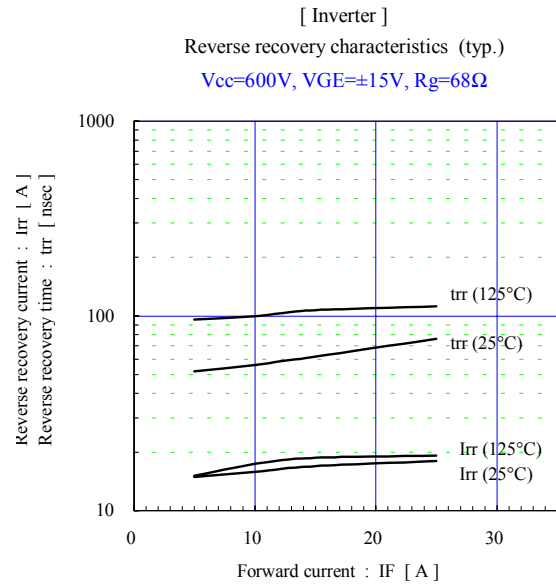
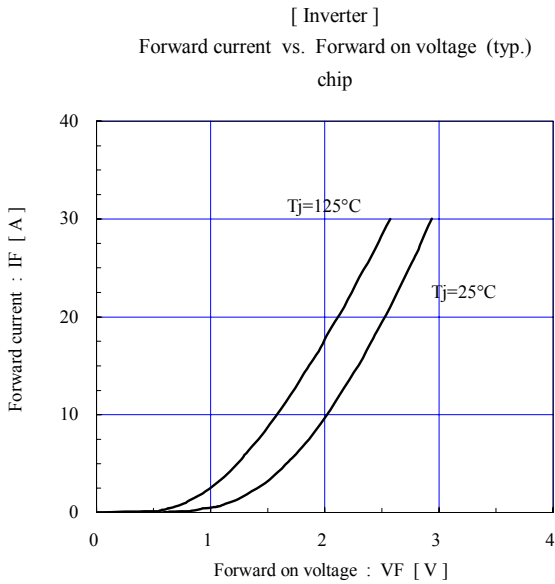

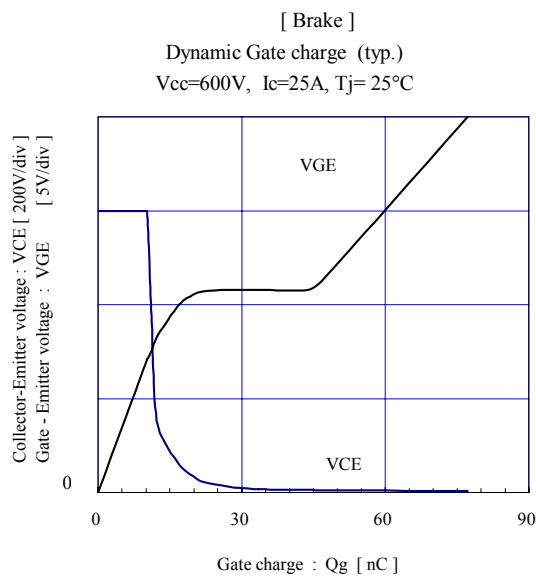
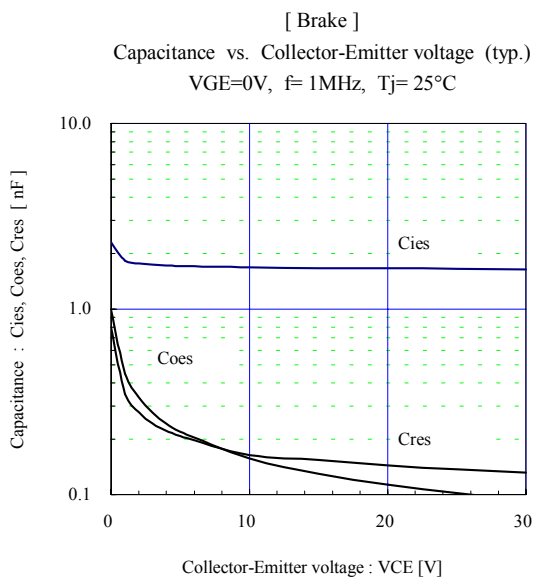
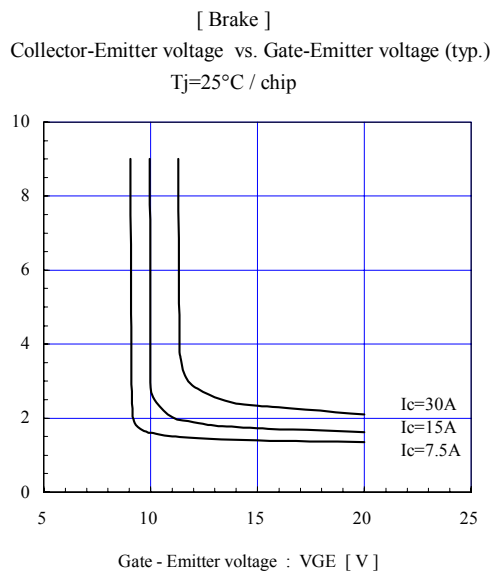
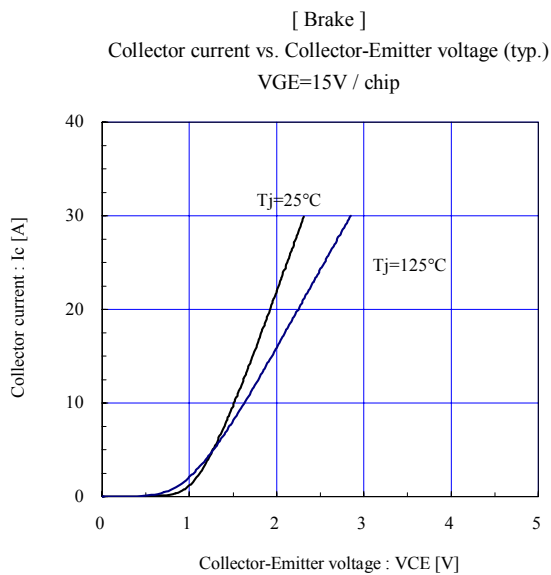
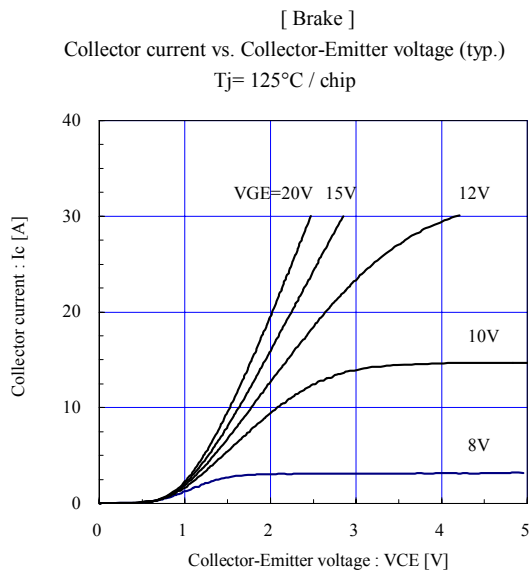
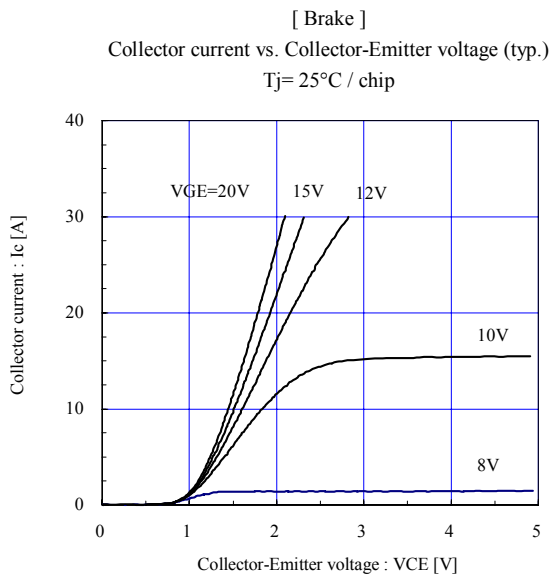

Outline Drawings, mm

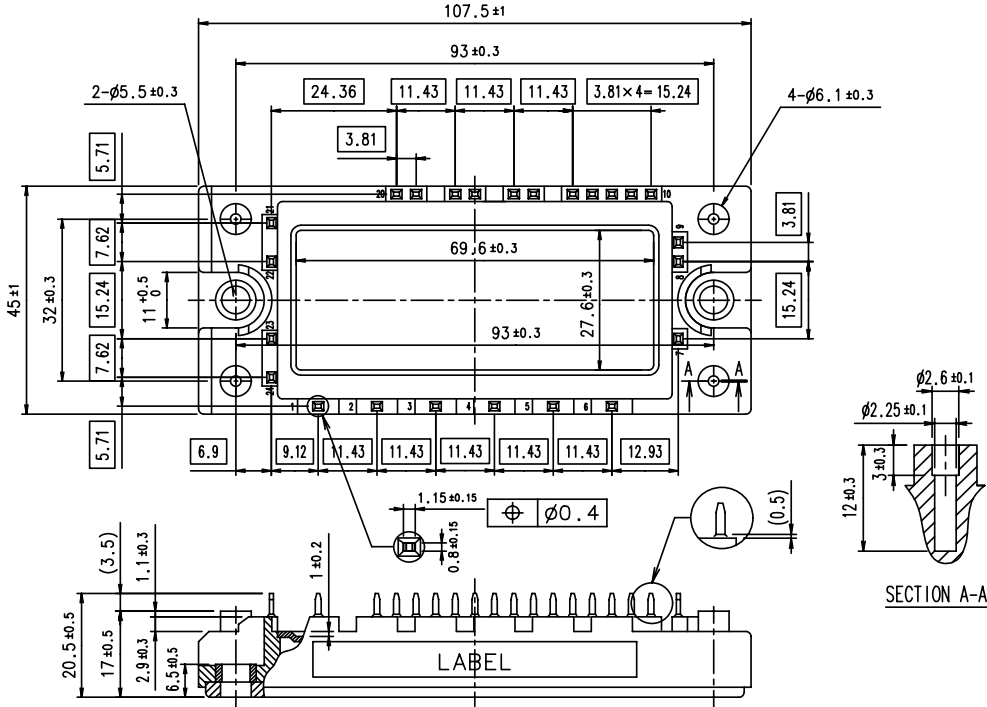

□ shows theoretical dimension.  
 ( ) shows reference dimension.