

EasyPIM™ Modul mit Trench/Feldstopp IGBT4 und Emitter Controlled 4 Diode und NTC  
EasyPIM™ module with Trench/Fieldstop IGBT4 and Emitter Controlled 4 diode and NTC

**Vorläufige Daten / preliminary data**

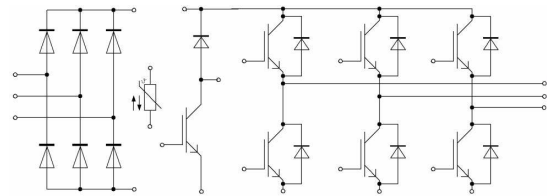

**V<sub>CEs</sub> = 1200V**  
**I<sub>C nom</sub> = 15A / I<sub>CRM</sub> = 30A**

**Typische Anwendungen**

- Hilfsumrichter
- Klimaanlage
- Motorantriebe

**Typical Applications**

- Auxiliary Inverters
- Airconditions
- Motor Drives

**Elektrische Eigenschaften**

- Niedrige Schaltverluste
- Trench IGBT 4
- V<sub>CEsat</sub> mit positivem Temperaturkoeffizienten
- niedriges V<sub>CEsat</sub>

**Electrical Features**

- Low Switching Losses
- Trench IGBT 4
- V<sub>CEsat</sub> with positive Temperature Coefficient
- Low V<sub>CEsat</sub>

**Mechanische Eigenschaften**

- Al<sub>2</sub>O<sub>3</sub> Substrat für kleinen thermischen Widerstand
- Kompaktes Design
- Lötverbindungs Technologie
- Robuste Montage durch integrierte Befestigungsklammern

**Mechanical Features**

- Al<sub>2</sub>O<sub>3</sub> Substrate for Low Thermal Resistance
- Compact Design
- Solder Contact Technology
- Rugged mounting due to integrated mounting clamps

**Module Label Code**

Barcode Code 128



DMX - Code



**Content of the Code**

| Content of the Code        | Digit   |
|----------------------------|---------|
| Module Serial Number       | 1 - 5   |
| Module Material Number     | 6 - 11  |
| Production Order Number    | 12 - 19 |
| Datecode (Production Year) | 20 - 21 |
| Datecode (Production Week) | 22 - 23 |

|                 |                                 |                      |
|-----------------|---------------------------------|----------------------|
| prepared by: DK | date of publication: 2009-10-30 | material no: 29257   |
| approved by: MB | revision: 2.2                   | UL approved (E83335) |

# Technische Information / technical information

IGBT-Module  
IGBT-modules

# FP15R12W1T4



**Vorläufige Daten**  
**preliminary data**

## IGBT-Wechselrichter / IGBT-inverter

### Höchstzulässige Werte / maximum rated values

|  |   |                             |          |        |
|--|---|-----------------------------|----------|--------|
| Kollektor-Emitter-Sperrspannung<br>collector-emitter voltage             | $T_{vj} = 25^{\circ}\text{C}$   | $V_{CES}$                   | 1200     | V      |
| Kollektor-Dauergleichstrom<br>DC-collector current                       | $T_C = 100^{\circ}\text{C}, T_{vj} = 175^{\circ}\text{C}$<br>$T_C = 25^{\circ}\text{C}, T_{vj} = 175^{\circ}\text{C}$ | $I_{C\text{ nom}}$<br>$I_C$ | 15<br>28 | A<br>A |
| Periodischer Kollektor Spitzenstrom<br>repetitive peak collector current | $t_P = 1\text{ ms}$   | $I_{CRM}$                   | 30       | A      |
| Gesamt-Verlustleistung<br>total power dissipation                        | $T_C = 25^{\circ}\text{C}, T_{vj} = 175^{\circ}\text{C}$  | $P_{tot}$                   | 130      | W      |
| Gate-Emitter-Spitzenspannung<br>gate-emitter peak voltage                |   | $V_{GES}$                   | +/-20    | V      |

### Charakteristische Werte / characteristic values

|  |   |   | min.                | typ.                    | max. |   |
|--|---|---|---------------------|-------------------------|------|---|
| Kollektor-Emitter Sättigungsspannung<br>collector-emitter saturation voltage | $I_C = 15\text{ A}, V_{GE} = 15\text{ V}$<br>$I_C = 15\text{ A}, V_{GE} = 15\text{ V}$<br>$I_C = 15\text{ A}, V_{GE} = 15\text{ V}$   | $T_{vj} = 25^{\circ}\text{C}$<br>$T_{vj} = 125^{\circ}\text{C}$<br>$T_{vj} = 150^{\circ}\text{C}$ | $V_{CE\text{ sat}}$ | 1,85<br>2,15<br>2,25    | 2,25 | V<br>V<br>V                                     |
| Gate-Schwellenspannung<br>gate threshold voltage                             | $I_C = 0,48\text{ mA}, V_{CE} = V_{GE}, T_{vj} = 25^{\circ}\text{C}$  |   | $V_{GEth}$          | 5,2<br>5,8              | 6,4  | V   |
| Gateladung<br>gate charge  | $V_{GE} = -15\text{ V} \dots +15\text{ V}$  |   | $Q_G$               | 0,12                    |      | $\mu\text{C}$                                   |
| Interner Gatewiderstand<br>internal gate resistor                            | $T_{vj} = 25^{\circ}\text{C}$   |   | $R_{Gint}$          | 0,0                     |      | $\Omega$  |
| Eingangskapazität<br>input capacitance                                       | $f = 1\text{ MHz}, T_{vj} = 25^{\circ}\text{C}, V_{CE} = 25\text{ V}, V_{GE} = 0\text{ V}$  |   | $C_{ies}$           | 0,89                    |      | nF  |
| Rückwirkungskapazität<br>reverse transfer capacitance                        | $f = 1\text{ MHz}, T_{vj} = 25^{\circ}\text{C}, V_{CE} = 25\text{ V}, V_{GE} = 0\text{ V}$  |   | $C_{res}$           | 0,03                    |      | nF  |
| Kollektor-Emitter Reststrom<br>collector-emitter cut-off current             | $V_{CE} = 1200\text{ V}, V_{GE} = 0\text{ V}, T_{vj} = 25^{\circ}\text{C}$  |   | $I_{CES}$           |                         | 1,0  | mA  |
| Gate-Emitter Reststrom<br>gate-emitter leakage current                       | $V_{CE} = 0\text{ V}, V_{GE} = 20\text{ V}, T_{vj} = 25^{\circ}\text{C}$  |   | $I_{GES}$           |                         | 400  | nA  |
| Einschaltverzögerungszeit (ind. Last)<br>turn-on delay time (inductive load) | $I_C = 15\text{ A}, V_{CE} = 600\text{ V}$<br>$V_{GE} = \pm 15\text{ V}$<br>$R_{Gon} = 39\ \Omega$  | $T_{vj} = 25^{\circ}\text{C}$<br>$T_{vj} = 125^{\circ}\text{C}$<br>$T_{vj} = 150^{\circ}\text{C}$ | $t_{d\text{ on}}$   | 0,055<br>0,055<br>0,055 |      | $\mu\text{s}$<br>$\mu\text{s}$<br>$\mu\text{s}$ |
| Anstiegszeit (induktive Last)<br>rise time (inductive load)                  | $I_C = 15\text{ A}, V_{CE} = 600\text{ V}$<br>$V_{GE} = \pm 15\text{ V}$<br>$R_{Gon} = 39\ \Omega$  | $T_{vj} = 25^{\circ}\text{C}$<br>$T_{vj} = 125^{\circ}\text{C}$<br>$T_{vj} = 150^{\circ}\text{C}$ | $t_r$               | 0,059<br>0,065<br>0,065 |      | $\mu\text{s}$<br>$\mu\text{s}$<br>$\mu\text{s}$ |
| Abschaltverzögerungszeit (ind. Last)<br>turn-off delay time (inductive load) | $I_C = 15\text{ A}, V_{CE} = 600\text{ V}$<br>$V_{GE} = \pm 15\text{ V}$<br>$R_{Goff} = 39\ \Omega$   | $T_{vj} = 25^{\circ}\text{C}$<br>$T_{vj} = 125^{\circ}\text{C}$<br>$T_{vj} = 150^{\circ}\text{C}$ | $t_{d\text{ off}}$  | 0,195<br>0,275<br>0,28  |      | $\mu\text{s}$<br>$\mu\text{s}$<br>$\mu\text{s}$ |
| Fallzeit (induktive Last)<br>fall time (inductive load)                      | $I_C = 15\text{ A}, V_{CE} = 600\text{ V}$<br>$V_{GE} = \pm 15\text{ V}$<br>$R_{Goff} = 39\ \Omega$   | $T_{vj} = 25^{\circ}\text{C}$<br>$T_{vj} = 125^{\circ}\text{C}$<br>$T_{vj} = 150^{\circ}\text{C}$ | $t_f$               | 0,145<br>0,19<br>0,215  |      | $\mu\text{s}$<br>$\mu\text{s}$<br>$\mu\text{s}$ |
| Einschaltverlustenergie pro Puls<br>turn-on energy loss per pulse            | $I_C = 15\text{ A}, V_{CE} = 600\text{ V}, L_s = 50\text{ nH}$<br>$V_{GE} = \pm 15\text{ V}, di/dt = 550\text{ A}/\mu\text{s} (T_{vj}=150^{\circ}\text{C})$<br>$R_{Gon} = 39\ \Omega$   | $T_{vj} = 25^{\circ}\text{C}$<br>$T_{vj} = 125^{\circ}\text{C}$<br>$T_{vj} = 150^{\circ}\text{C}$ | $E_{on}$            | 1,30<br>1,75<br>1,95    |      | mJ<br>mJ<br>mJ                                  |
| Abschaltverlustenergie pro Puls<br>turn-off energy loss per pulse            | $I_C = 15\text{ A}, V_{CE} = 600\text{ V}, L_s = 50\text{ nH}$<br>$V_{GE} = \pm 15\text{ V}, du/dt = 3500\text{ V}/\mu\text{s} (T_{vj}=150^{\circ}\text{C})$<br>$R_{Goff} = 39\ \Omega$ | $T_{vj} = 25^{\circ}\text{C}$<br>$T_{vj} = 125^{\circ}\text{C}$<br>$T_{vj} = 150^{\circ}\text{C}$ | $E_{off}$           | 0,83<br>1,20<br>1,35    |      | mJ<br>mJ<br>mJ                                  |
| Kurzschlussverhalten<br>SC data  | $V_{GE} \leq 15\text{ V}, V_{CC} = 800\text{ V}$<br>$V_{CEmax} = V_{CES} - L_{sCE} \cdot di/dt$ $t_P \leq 10\ \mu\text{s}, T_{vj} = 150^{\circ}\text{C}$                                |   | $I_{SC}$            | 55                      |      | A   |
| Innerer Wärmewiderstand<br>thermal resistance, junction to case              | pro IGBT / per IGBT   |   | $R_{thJC}$          | 1,05                    | 1,15 | K/W   |
| Übergangs-Wärmewiderstand<br>thermal resistance, case to heatsink            | pro IGBT / per IGBT<br>$\lambda_{Paste} = 1\text{ W}/(\text{m}\cdot\text{K})$ / $\lambda_{grease} = 1\text{ W}/(\text{m}\cdot\text{K})$   |   | $R_{thCH}$          | 1,05                    |      | K/W   |

|                 |                                 |
|-----------------|---------------------------------|
| prepared by: DK | date of publication: 2009-10-30 |
| approved by: MB | revision: 2.2                   |

# Technische Information / technical information

IGBT-Module  
IGBT-modules

# FP15R12W1T4



## Vorläufige Daten preliminary data

### Diode-Wechselrichter / diode-inverter

#### Höchstzulässige Werte / maximum rated values

|   |  |           |              |  |
|---|--|-----------|--------------|--|
| Periodische Spitzensperrspannung<br>repetitive peak reverse voltage | $T_{vj} = 25^{\circ}\text{C}$  | $V_{RRM}$ | 1200         | V  |
| Dauergleichstrom<br>DC forward current                              |  | $I_F$     | 15           | A  |
| Periodischer Spitzenstrom<br>repetitive peak forward current        | $t_p = 1\text{ ms}$  | $I_{FRM}$ | 30           | A  |
| Grenzlastintegral<br>$I^2t$ - value                                 | $V_R = 0\text{ V}, t_p = 10\text{ ms}, T_{vj} = 125^{\circ}\text{C}$<br>$V_R = 0\text{ V}, t_p = 10\text{ ms}, T_{vj} = 150^{\circ}\text{C}$ | $I^2t$    | 16,0<br>14,0 | $\text{A}^2\text{s}$<br>$\text{A}^2\text{s}$ |

#### Charakteristische Werte / characteristic values

|   |   |                                | min. | typ. | max. |               |
|---|---|--------------------------------|------|------|------|---------------|
| Durchlassspannung<br>forward voltage                              | $I_F = 15\text{ A}, V_{GE} = 0\text{ V}$  | $T_{vj} = 25^{\circ}\text{C}$  |      | 2,00 | 2,65 | V             |
|   | $I_F = 15\text{ A}, V_{GE} = 0\text{ V}$  | $T_{vj} = 125^{\circ}\text{C}$ |      | 2,10 |      | V             |
|   | $I_F = 15\text{ A}, V_{GE} = 0\text{ V}$  | $T_{vj} = 150^{\circ}\text{C}$ |      | 2,10 |      | V             |
| Rückstromspitze<br>peak reverse recovery current                  | $I_F = 15\text{ A}, -di_F/dt = 550\text{ A}/\mu\text{s} (T_{vj}=150^{\circ}\text{C})$   | $T_{vj} = 25^{\circ}\text{C}$  |      | 13,0 |      | A             |
|   | $V_R = 600\text{ V}$  | $T_{vj} = 125^{\circ}\text{C}$ |      | 12,0 |      | A             |
|   | $V_{GE} = -15\text{ V}$   | $T_{vj} = 150^{\circ}\text{C}$ |      | 12,0 |      | A             |
| Sperrverzögerungsladung<br>recovered charge                       | $I_F = 15\text{ A}, -di_F/dt = 550\text{ A}/\mu\text{s} (T_{vj}=150^{\circ}\text{C})$   | $T_{vj} = 25^{\circ}\text{C}$  |      | 1,20 |      | $\mu\text{C}$ |
|   | $V_R = 600\text{ V}$  | $T_{vj} = 125^{\circ}\text{C}$ |      | 2,05 |      | $\mu\text{C}$ |
|   | $V_{GE} = -15\text{ V}$   | $T_{vj} = 150^{\circ}\text{C}$ |      | 2,40 |      | $\mu\text{C}$ |
| Abschaltenergie pro Puls<br>reverse recovery energy               | $I_F = 15\text{ A}, -di_F/dt = 550\text{ A}/\mu\text{s} (T_{vj}=150^{\circ}\text{C})$   | $T_{vj} = 25^{\circ}\text{C}$  |      | 0,37 |      | mJ            |
|   | $V_R = 600\text{ V}$  | $T_{vj} = 125^{\circ}\text{C}$ |      | 0,68 |      | mJ            |
|   | $V_{GE} = -15\text{ V}$   | $T_{vj} = 150^{\circ}\text{C}$ |      | 0,80 |      | mJ            |
| Innerer Wärmewiderstand<br>thermal resistance, junction to case   | pro Diode / per diode   | $R_{thJC}$                     |      | 1,75 | 1,90 | K/W           |
| Übergangs-Wärmewiderstand<br>thermal resistance, case to heatsink | pro Diode / per diode<br>$\lambda_{Paste} = 1\text{ W}/(\text{m}\cdot\text{K}) / \lambda_{grease} = 1\text{ W}/(\text{m}\cdot\text{K})$ | $R_{thCH}$                     |      | 1,30 |      | K/W           |

### Diode-Gleichrichter / diode-rectifier

#### Höchstzulässige Werte / maximum rated values

|   |  |             |      |                      |
|---|--|-------------|------|----------------------|
| Periodische Rückw. Spitzensperrspannung<br>repetitive peak reverse voltage          | $T_{vj} = 25^{\circ}\text{C}$                      | $V_{RRM}$   | 1600 | V                    |
| Durchlassstrom Grenzeffektivwert pro Dio.<br>forward current RMS maximum per diode  | $T_C = 80^{\circ}\text{C}$                         | $I_{FRMSM}$ | 30   | A                    |
| Gleichrichter Ausgang Grenzeffektivstrom<br>maximum RMS current at Rectifier output | $T_C = 80^{\circ}\text{C}$                         | $I_{RMSM}$  | 30   | A                    |
| Stoßstrom Grenzwert<br>surge forward current  | $t_p = 10\text{ ms}, T_{vj} = 25^{\circ}\text{C}$  | $I_{FSM}$   | 300  | A                    |
|   | $t_p = 10\text{ ms}, T_{vj} = 150^{\circ}\text{C}$ |             | 245  | A                    |
| Grenzlastintegral<br>$I^2t$ - value   | $t_p = 10\text{ ms}, T_{vj} = 25^{\circ}\text{C}$  | $I^2t$      | 450  | $\text{A}^2\text{s}$ |
|   | $t_p = 10\text{ ms}, T_{vj} = 150^{\circ}\text{C}$ |             | 300  | $\text{A}^2\text{s}$ |

#### Charakteristische Werte / characteristic values

|   |   |            | min. | typ. | max. |     |
|---|---|------------|------|------|------|-----|
| Durchlassspannung<br>forward voltage                              | $T_{vj} = 150^{\circ}\text{C}, I_F = 15\text{ A}$   | $V_F$      |      | 0,85 |      | V   |
| Sperrstrom<br>reverse current                                     | $T_{vj} = 150^{\circ}\text{C}, V_R = 1600\text{ V}$   | $I_R$      |      | 1,00 |      | mA  |
| Innerer Wärmewiderstand<br>thermal resistance, junction to case   | pro Diode<br>per diode  | $R_{thJC}$ |      | 1,20 | 1,35 | K/W |
| Übergangs-Wärmewiderstand<br>thermal resistance, case to heatsink | pro Diode / per diode<br>$\lambda_{Paste} = 1\text{ W}/(\text{m}\cdot\text{K}) / \lambda_{grease} = 1\text{ W}/(\text{m}\cdot\text{K})$ | $R_{thCH}$ |      | 1,15 |      | K/W |

|                 |                                 |
|-----------------|---------------------------------|
| prepared by: DK | date of publication: 2009-10-30 |
| approved by: MB | revision: 2.2                   |

# Technische Information / technical information

IGBT-Module  
IGBT-modules

# FP15R12W1T4



**Vorläufige Daten**  
**preliminary data**

## IGBT-Brems-Chopper / IGBT-brake-chopper

### Höchstzulässige Werte / maximum rated values

|  |   |                     |          |        |
|--|---|---------------------|----------|--------|
| Kollektor-Emitter-Sperrspannung<br>collector-emitter voltage             | $T_{vj} = 25^{\circ}\text{C}$   | $V_{CES}$           | 1200     | V      |
| Kollektor-Dauergleichstrom<br>DC-collector current                       | $T_C = 100^{\circ}\text{C}, T_{vj} = 175^{\circ}\text{C}$<br>$T_C = 25^{\circ}\text{C}, T_{vj} = 175^{\circ}\text{C}$ | $I_{Cnom}$<br>$I_C$ | 15<br>28 | A<br>A |
| Periodischer Kollektor Spitzenstrom<br>repetitive peak collector current | $t_P = 1 \text{ ms}$  | $I_{CRM}$           | 30       | A      |
| Gesamt-Verlustleistung<br>total power dissipation                        | $T_C = 25^{\circ}\text{C}, T_{vj} = 175^{\circ}\text{C}$  | $P_{tot}$           | 130      | W      |
| Gate-Emitter-Spitzenspannung<br>gate-emitter peak voltage                |   | $V_{GES}$           | +/-20    | V      |

### Charakteristische Werte / characteristic values

|  |   |   | min.                 | typ.                 | max.                    |             |   |
|--|---|---|----------------------|----------------------|-------------------------|-------------|---|
| Kollektor-Emitter Sättigungsspannung<br>collector-emitter saturation voltage | $I_C = 15 \text{ A}, V_{GE} = 15 \text{ V}$<br>$I_C = 15 \text{ A}, V_{GE} = 15 \text{ V}$<br>$I_C = 15 \text{ A}, V_{GE} = 15 \text{ V}$ | $T_{vj} = 25^{\circ}\text{C}$<br>$T_{vj} = 125^{\circ}\text{C}$<br>$T_{vj} = 150^{\circ}\text{C}$ | $V_{CE \text{ sat}}$ | 1,85<br>2,15<br>2,25 | 2,25                    | V<br>V<br>V |   |
| Gate-Schwellenspannung<br>gate threshold voltage                             | $I_C = 0,48 \text{ mA}, V_{CE} = V_{GE}, T_{vj} = 25^{\circ}\text{C}$   |   | $V_{GEth}$           | 5,2                  | 5,8                     | 6,4         | V   |
| Gateladung<br>gate charge  | $V_{GE} = -15 \text{ V} \dots +15 \text{ V}$  |   | $Q_G$                |                      | 0,12                    |             | $\mu\text{C}$                                   |
| Interner Gatewiderstand<br>internal gate resistor                            | $T_{vj} = 25^{\circ}\text{C}$   |   | $R_{Gint}$           |                      | 0,00                    |             | $\Omega$  |
| Eingangskapazität<br>input capacitance                                       | $f = 1 \text{ MHz}, T_{vj} = 25^{\circ}\text{C}, V_{CE} = 25 \text{ V}, V_{GE} = 0 \text{ V}$   |   | $C_{ies}$            |                      | 0,89                    |             | nF  |
| Rückwirkungskapazität<br>reverse transfer capacitance                        | $f = 1 \text{ MHz}, T_{vj} = 25^{\circ}\text{C}, V_{CE} = 25 \text{ V}, V_{GE} = 0 \text{ V}$   |   | $C_{res}$            |                      | 0,03                    |             | nF  |
| Kollektor-Emitter Reststrom<br>collector-emitter cut-off current             | $V_{CE} = 1200 \text{ V}, V_{GE} = 0 \text{ V}, T_{vj} = 25^{\circ}\text{C}$  |   | $I_{CES}$            |                      |                         | 1,0         | mA  |
| Gate-Emitter Reststrom<br>gate-emitter leakage current                       | $V_{CE} = 0 \text{ V}, V_{GE} = 20 \text{ V}, T_{vj} = 25^{\circ}\text{C}$  |   | $I_{GES}$            |                      |                         | 400         | nA  |
| Einschaltverzögerungszeit (ind. Last)<br>turn-on delay time (inductive load) | $I_C = 15 \text{ A}, V_{CE} = 600 \text{ V}$<br>$V_{GE} = \pm 15 \text{ V}$<br>$R_{Gon} = 43 \Omega$                                      | $T_{vj} = 25^{\circ}\text{C}$<br>$T_{vj} = 125^{\circ}\text{C}$<br>$T_{vj} = 150^{\circ}\text{C}$ | $t_{d \text{ on}}$   |                      | 0,065<br>0,065<br>0,065 |             | $\mu\text{s}$<br>$\mu\text{s}$<br>$\mu\text{s}$ |
| Anstiegszeit (induktive Last)<br>rise time (inductive load)                  | $I_C = 15 \text{ A}, V_{CE} = 600 \text{ V}$<br>$V_{GE} = \pm 15 \text{ V}$<br>$R_{Gon} = 43 \Omega$                                      | $T_{vj} = 25^{\circ}\text{C}$<br>$T_{vj} = 125^{\circ}\text{C}$<br>$T_{vj} = 150^{\circ}\text{C}$ | $t_r$                |                      | 0,06<br>0,065<br>0,065  |             | $\mu\text{s}$<br>$\mu\text{s}$<br>$\mu\text{s}$ |
| Abschaltverzögerungszeit (ind. Last)<br>turn-off delay time (inductive load) | $I_C = 15 \text{ A}, V_{CE} = 600 \text{ V}$<br>$V_{GE} = \pm 15 \text{ V}$<br>$R_{Goff} = 43 \Omega$                                     | $T_{vj} = 25^{\circ}\text{C}$<br>$T_{vj} = 125^{\circ}\text{C}$<br>$T_{vj} = 150^{\circ}\text{C}$ | $t_{d \text{ off}}$  |                      | 0,21<br>0,28<br>0,285   |             | $\mu\text{s}$<br>$\mu\text{s}$<br>$\mu\text{s}$ |
| Fallzeit (induktive Last)<br>fall time (inductive load)                      | $I_C = 15 \text{ A}, V_{CE} = 600 \text{ V}$<br>$V_{GE} = \pm 15 \text{ V}$<br>$R_{Goff} = 43 \Omega$                                     | $T_{vj} = 25^{\circ}\text{C}$<br>$T_{vj} = 125^{\circ}\text{C}$<br>$T_{vj} = 150^{\circ}\text{C}$ | $t_f$                |                      | 0,17<br>0,20<br>0,225   |             | $\mu\text{s}$<br>$\mu\text{s}$<br>$\mu\text{s}$ |
| Einschaltverlustenergie pro Puls<br>turn-on energy loss per pulse            | $I_C = 15 \text{ A}, V_{CE} = 600 \text{ V}, L_s = 50 \text{ nH}$<br>$V_{GE} = \pm 15 \text{ V}$<br>$R_{Gon} = 43 \Omega$                 | $T_{vj} = 25^{\circ}\text{C}$<br>$T_{vj} = 125^{\circ}\text{C}$<br>$T_{vj} = 150^{\circ}\text{C}$ | $E_{on}$             |                      | 1,35<br>1,80<br>2,00    |             | mJ<br>mJ<br>mJ                                  |
| Abschaltverlustenergie pro Puls<br>turn-off energy loss per pulse            | $I_C = 15 \text{ A}, V_{CE} = 600 \text{ V}, L_s = 50 \text{ nH}$<br>$V_{GE} = \pm 15 \text{ V}$<br>$R_{Goff} = 43 \Omega$                | $T_{vj} = 25^{\circ}\text{C}$<br>$T_{vj} = 125^{\circ}\text{C}$<br>$T_{vj} = 150^{\circ}\text{C}$ | $E_{off}$            |                      | 0,85<br>1,20<br>1,35    |             | mJ<br>mJ<br>mJ                                  |
| Kurzschlussverhalten<br>SC data  | $V_{GE} \leq 15 \text{ V}, V_{CC} = 800 \text{ V}$<br>$V_{CEmax} = V_{CES} - L_{sCE} \cdot di/dt$   | $t_P \leq 10 \mu\text{s}, T_{vj} = 150^{\circ}\text{C}$   | $I_{SC}$             |                      | 55                      |             | A   |
| Innerer Wärmewiderstand<br>thermal resistance, junction to case              | pro IGBT / per IGBT   |   | $R_{thJC}$           |                      | 1,05                    | 1,15        | K/W   |
| Übergangs-Wärmewiderstand<br>thermal resistance, case to heatsink            | pro IGBT / per IGBT<br>$\lambda_{Paste} = 1 \text{ W/(m}\cdot\text{K)} / \lambda_{grease} = 1 \text{ W/(m}\cdot\text{K)}$                 |   | $R_{thCH}$           |                      | 1,05                    |             | K/W   |

|                 |                                 |
|-----------------|---------------------------------|
| prepared by: DK | date of publication: 2009-10-30 |
| approved by: MB | revision: 2.2                   |

**Vorläufige Daten**  
**preliminary data**

**Diode-Brems-Chopper / Diode-brake-chopper**

**Höchstzulässige Werte / maximum rated values**

|   |  |           |      |                      |
|---|--|-----------|------|----------------------|
| Periodische Spitzensperrspannung<br>repetitive peak reverse voltage | $T_{vj} = 25^{\circ}\text{C}$  | $V_{RRM}$ | 1200 | V                    |
| Dauergleichstrom<br>DC forward current                              |  | $I_F$     | 10   | A                    |
| Periodischer Spitzenstrom<br>repetitive peak forw. current          | $t_p = 1\text{ ms}$  | $I_{FRM}$ | 20   | A                    |
| Grenzlastintegral<br>$I^2t$ - value                                 | $V_R = 0\text{ V}, t_p = 10\text{ ms}, T_{vj} = 125^{\circ}\text{C}$ | $I^2t$    | 16,0 | $\text{A}^2\text{s}$ |

**Charakteristische Werte / characteristic values**

|   |   |                                | min. | typ. | max. |               |
|---|---|--------------------------------|------|------|------|---------------|
| Durchlassspannung<br>forward voltage                              | $I_F = 10\text{ A}, V_{GE} = 0\text{ V}$  | $T_{vj} = 25^{\circ}\text{C}$  |      | 1,75 | 2,25 | V             |
|   | $I_F = 10\text{ A}, V_{GE} = 0\text{ V}$  | $T_{vj} = 125^{\circ}\text{C}$ |      | 1,75 |      | V             |
|   | $I_F = 10\text{ A}, V_{GE} = 0\text{ V}$  | $T_{vj} = 150^{\circ}\text{C}$ |      | 1,75 |      | V             |
| Rückstromspitze<br>peak reverse recovery current                  | $I_F = 10\text{ A}, -di_F/dt = 500\text{ A}/\mu\text{s} (T_{vj}=150^{\circ}\text{C})$   | $T_{vj} = 25^{\circ}\text{C}$  |      | 12,0 |      | A             |
|   | $V_R = 600\text{ V}$  | $T_{vj} = 125^{\circ}\text{C}$ |      | 10,0 |      | A             |
|   | $V_{GE} = -15\text{ V}$   | $T_{vj} = 150^{\circ}\text{C}$ |      | 8,00 |      | A             |
| Sperrverzögerungsladung<br>recovered charge                       | $I_F = 10\text{ A}, -di_F/dt = 500\text{ A}/\mu\text{s} (T_{vj}=150^{\circ}\text{C})$   | $T_{vj} = 25^{\circ}\text{C}$  |      | 0,90 |      | $\mu\text{C}$ |
|   | $V_R = 600\text{ V}$  | $T_{vj} = 125^{\circ}\text{C}$ |      | 1,70 |      | $\mu\text{C}$ |
|   | $V_{GE} = -15\text{ V}$   | $T_{vj} = 150^{\circ}\text{C}$ |      | 1,90 |      | $\mu\text{C}$ |
| Abschaltenergie pro Puls<br>reverse recovery energy               | $I_F = 10\text{ A}, -di_F/dt = 500\text{ A}/\mu\text{s} (T_{vj}=150^{\circ}\text{C})$   | $T_{vj} = 25^{\circ}\text{C}$  |      | 0,24 |      | mJ            |
|   | $V_R = 600\text{ V}$  | $T_{vj} = 125^{\circ}\text{C}$ |      | 0,52 |      | mJ            |
|   | $V_{GE} = -15\text{ V}$   | $T_{vj} = 150^{\circ}\text{C}$ |      | 0,59 |      | mJ            |
| Innerer Wärmewiderstand<br>thermal resistance, junction to case   | pro Diode / per diode   | $R_{thJC}$                     |      | 1,75 | 1,90 | K/W           |
| Übergangs-Wärmewiderstand<br>thermal resistance, case to heatsink | pro Diode / per diode<br>$\lambda_{Paste} = 1\text{ W}/(\text{m}\cdot\text{K}) \lambda_{grease} = 1\text{ W}/(\text{m}\cdot\text{K})$ | $R_{thCH}$                     |      | 1,30 |      | K/W           |

**NTC-Widerstand / NTC-thermistor**

**Charakteristische Werte / characteristic values**

|  |   |              | min. | typ. | max. |            |
|--|---|--------------|------|------|------|------------|
| Nennwiderstand<br>rated resistance                 | $T_C = 25^{\circ}\text{C}$                                    | $R_{25}$     |      | 5,00 |      | k $\Omega$ |
| Abweichung von $R_{100}$<br>deviation of $R_{100}$ | $T_C = 100^{\circ}\text{C}, R_{100} = 493\ \Omega$            | $\Delta R/R$ | -5   |      | 5    | %          |
| Verlustleistung<br>power dissipation               | $T_C = 25^{\circ}\text{C}$                                    | $P_{25}$     |      |      | 20,0 | mW         |
| B-Wert<br>B-value                                  | $R_2 = R_{25} \exp [B_{25/50}(1/T_2 - 1/(298,15\text{ K}))]$  | $B_{25/50}$  |      | 3375 |      | K          |
| B-Wert<br>B-value                                  | $R_2 = R_{25} \exp [B_{25/80}(1/T_2 - 1/(298,15\text{ K}))]$  | $B_{25/80}$  |      | 3411 |      | K          |
| B-Wert<br>B-value                                  | $R_2 = R_{25} \exp [B_{25/100}(1/T_2 - 1/(298,15\text{ K}))]$ | $B_{25/100}$ |      | 3433 |      | K          |

Angaben gemäß gültiger Application Note.  
Specification according to the valid application note.

|                 |                                 |
|-----------------|---------------------------------|
| prepared by: DK | date of publication: 2009-10-30 |
| approved by: MB | revision: 2.2                   |

# Technische Information / technical information

IGBT-Module  
IGBT-modules

## FP15R12W1T4



### Vorläufige Daten preliminary data

#### Modul / module

|  |   |                                |                                |              |          |
|--|---|--------------------------------|--------------------------------|--------------|----------|
| Isolations-Prüfspannung<br>insulation test voltage   | RMS, f = 50 Hz, t = 1 min   | $V_{ISOL}$                     | 2,5                            |              | kV       |
| Material für innere Isolation<br>material for internal insulation                            |   |                                | Al <sub>2</sub> O <sub>3</sub> |              |          |
| Kriechstrecke<br>creepage distance   | Kontakt - Kühlkörper / terminal to heatsink<br>Kontakt - Kontakt / terminal to terminal |                                | 11,5<br>6,3                    |              | mm       |
| Luftstrecke<br>clearance distance  | Kontakt - Kühlkörper / terminal to heatsink<br>Kontakt - Kontakt / terminal to terminal |                                | 10,0<br>5,0                    |              | mm       |
| Vergleichszahl der Kriechwegbildung<br>comparative tracking index                            |   | CTI                            | > 200                          |              |          |
|  |   |                                | min.                           | typ.         | max.     |
| Modulinduktivität<br>stray inductance module   |   | $L_{sCE}$                      |                                | 30           | nH       |
| Modulleitungswiderstand,<br>Anschlüsse - Chip<br>module lead resistance,<br>terminals - chip | $T_C = 25^\circ\text{C}$ , pro Schalter / per switch                                    | $R_{CC'+EE'}$<br>$R_{AA'+CC'}$ |                                | 8,00<br>6,00 | mΩ       |
| Höchstzulässige Sperschichttemperatur<br>maximum junction temperature                        | Wechselrichter, Brems-Chopper / Inverter, Brake-Chopper<br>Gleichrichter / rectifier    | $T_{vj\ max}$                  |                                | 175<br>150   | °C<br>°C |
| Temperatur im Schaltbetrieb<br>temperature under switching conditions                        | Wechselrichter, Brems-Chopper / Inverter, Brake-Chopper<br>Gleichrichter / rectifier    | $T_{vj\ op}$                   | -40<br>-40                     | 150<br>150   | °C<br>°C |
| Lagertemperatur<br>storage temperature   |   | $T_{stg}$                      | -40                            | 125          | °C       |
| Anpresskraft für mech. Bef. pro Feder<br>mounting force per clamp                            |   | F                              | 20                             | -            | 50 N     |
| Gewicht<br>weight  |   | G                              |                                | 24           | g        |

Der Strom im Dauerbetrieb ist auf 30A effektiv pro Anschlusspin begrenzt.  
The current under continuous operation is limited to 30A rms per connector pin.

|                 |                                 |
|-----------------|---------------------------------|
| prepared by: DK | date of publication: 2009-10-30 |
| approved by: MB | revision: 2.2                   |

**Vorläufige Daten**  
**preliminary data**

**Ausgangskennlinie IGBT-Wechselr. (typisch)**  
**output characteristic IGBT-inverter (typical)**  
 $I_c = f(V_{CE})$   
 $V_{GE} = 15\text{ V}$

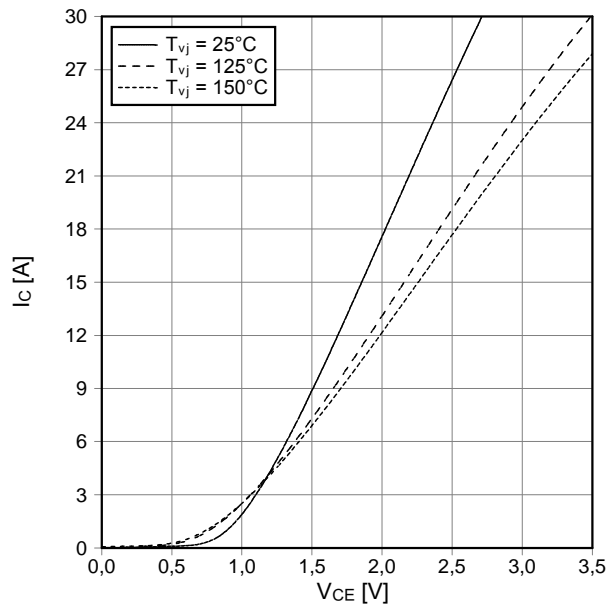

**Ausgangskennlinienfeld IGBT-Wechselr. (typisch)**  
**output characteristic IGBT-inverter (typical)**  
 $I_c = f(V_{CE})$   
 $T_{vj} = 150^\circ\text{C}$

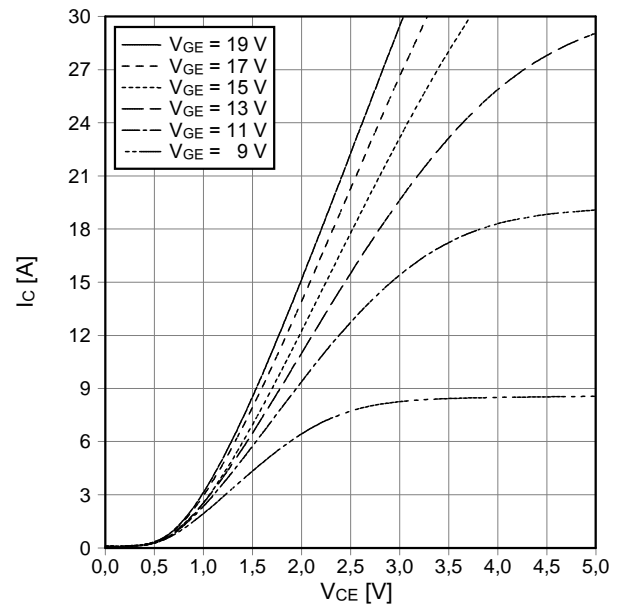

**Übertragungscharakteristik IGBT-Wechselr. (typisch)**  
**transfer characteristic IGBT-inverter (typical)**  
 $I_c = f(V_{GE})$   
 $V_{CE} = 20\text{ V}$

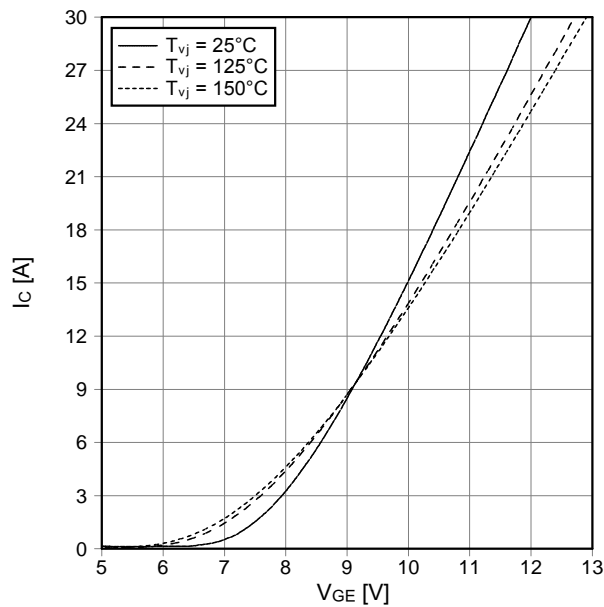

**Schaltverluste IGBT-Wechselr. (typisch)**  
**switching losses IGBT-inverter (typical)**  
 $E_{on} = f(I_c)$ ,  $E_{off} = f(I_c)$   
 $V_{GE} = \pm 15\text{ V}$ ,  $R_{Gon} = 39\ \Omega$ ,  $R_{Goff} = 39\ \Omega$ ,  $V_{CE} = 600\text{ V}$

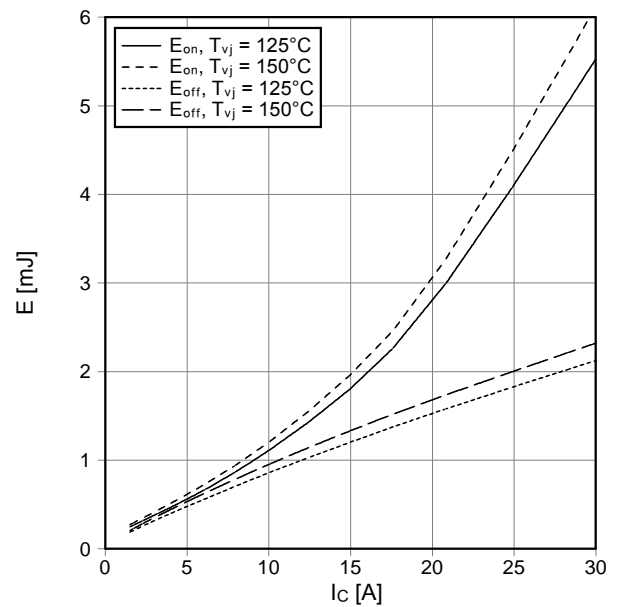

|                 |                                 |
|-----------------|---------------------------------|
| prepared by: DK | date of publication: 2009-10-30 |
| approved by: MB | revision: 2.2                   |

**Vorläufige Daten**  
**preliminary data**

**Schaltverluste IGBT-Wechselr. (typisch)**  
**switching losses IGBT-Inverter (typical)**  
 $E_{on} = f(R_G), E_{off} = f(R_G)$   
 $V_{GE} = \pm 15\text{ V}, I_c = 15\text{ A}, V_{CE} = 600\text{ V}$

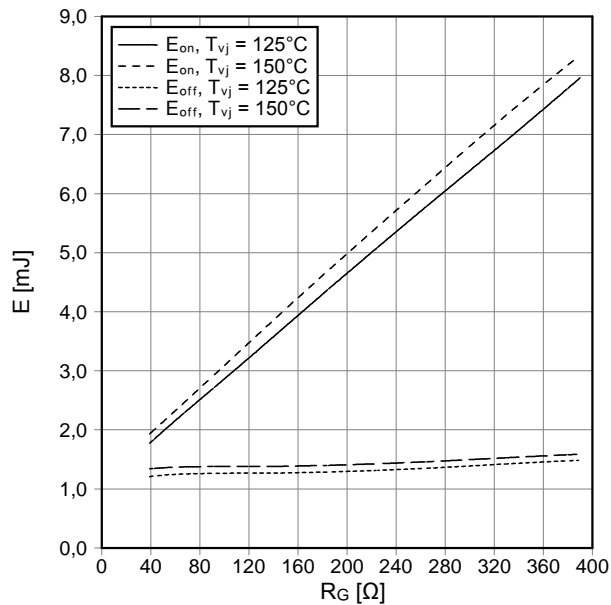

**Transienter Wärmewiderstand IGBT-Wechselr.**  
**transient thermal impedance IGBT-inverter**  
 $Z_{thJH} = f(t)$

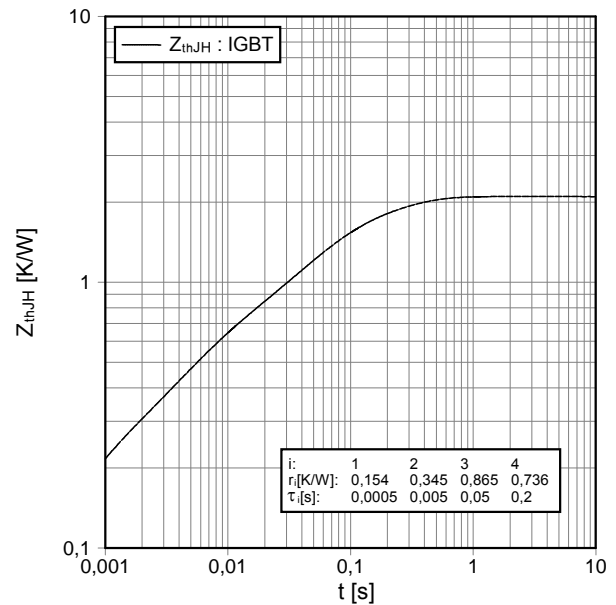

**Sicherer Rückwärts-Arbeitsbereich IGBT-Wr. (RBSOA)**  
**reverse bias safe operating area IGBT-inv. (RBSOA)**  
 $I_c = f(V_{CE})$   
 $V_{GE} = \pm 15\text{ V}, R_{Goff} = 39\ \Omega, T_{vj} = 150^\circ\text{C}$

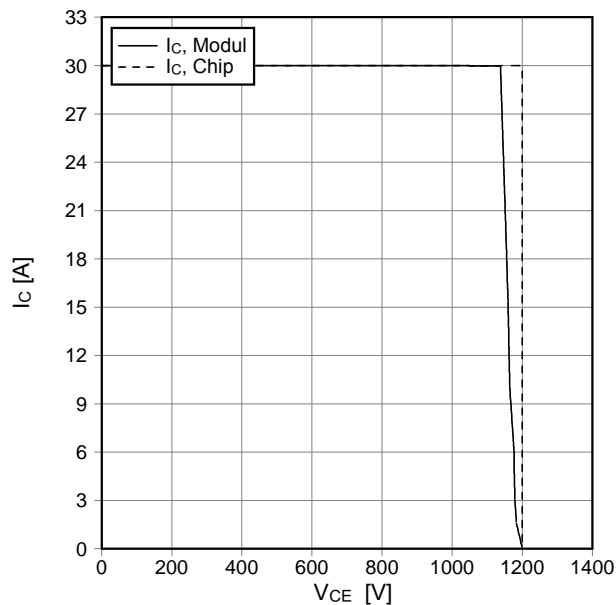

**Durchlasskennlinie der Diode-Wechselr. (typisch)**  
**forward characteristic of diode-inverter (typical)**  
 $I_F = f(V_F)$

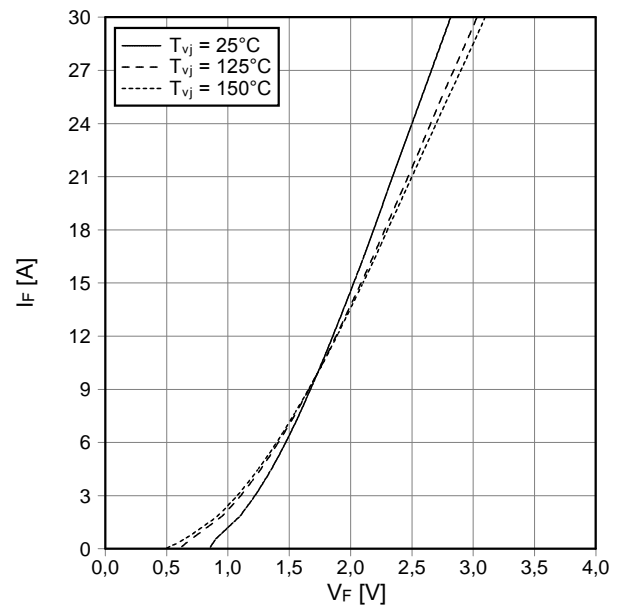

|                 |                                 |
|-----------------|---------------------------------|
| prepared by: DK | date of publication: 2009-10-30 |
| approved by: MB | revision: 2.2                   |



Vorläufige Daten  
preliminary data

Schaltverluste Diode-Wechselr. (typisch)  
switching losses diode-inverter (typical)

$E_{rec} = f(I_F)$   
 $R_{Gon} = 39 \Omega, V_{CE} = 600 V$

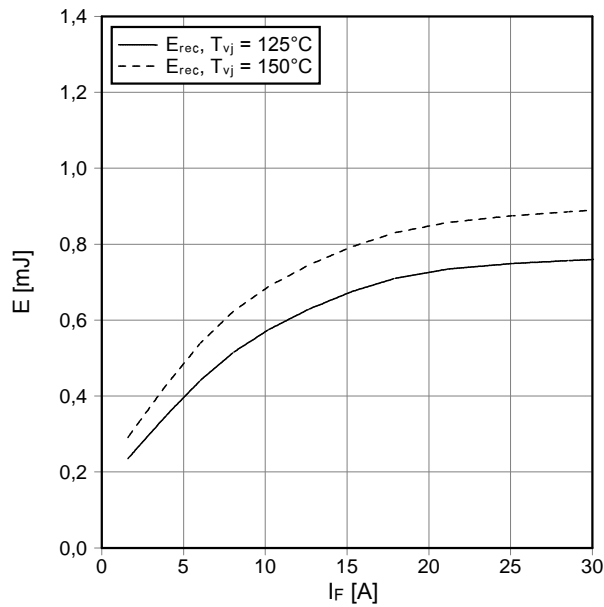

Schaltverluste Diode-Wechselr. (typisch)  
switching losses diode-inverter (typical)

$E_{rec} = f(R_G)$   
 $I_F = 15 A, V_{CE} = 600 V$

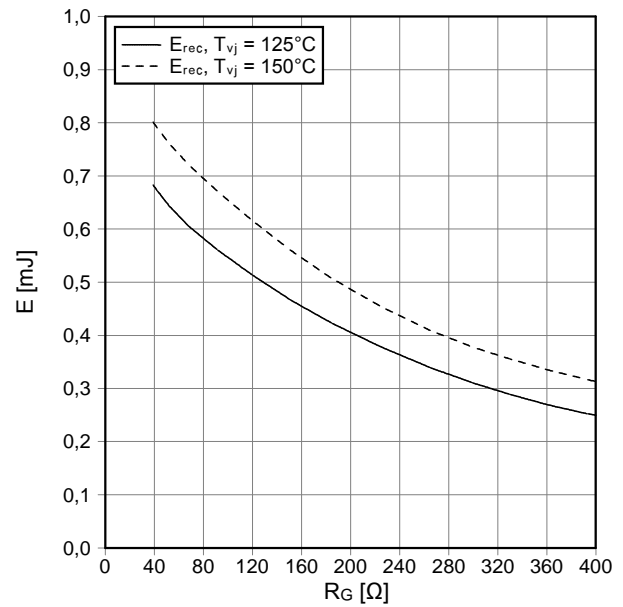

Transienter Wärmewiderstand Diode-Wechselr.  
transient thermal impedance diode-inverter

$Z_{thJH} = f(t)$

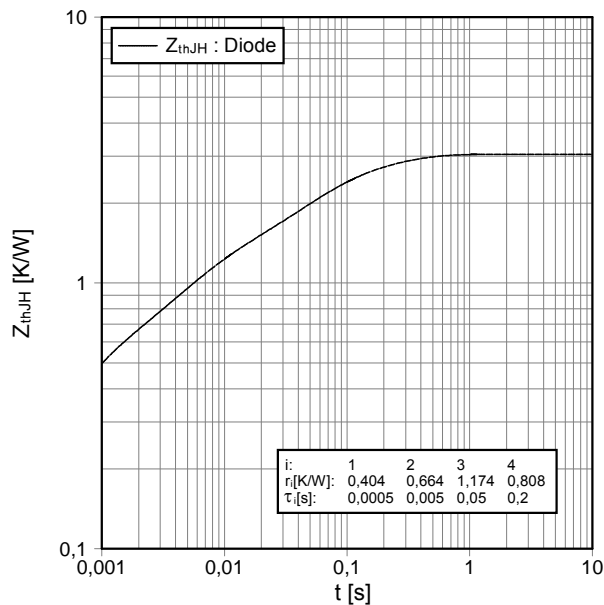

Durchlasskennlinie der Diode-Gleichrichter (typisch)  
forward characteristic of diode-rectifier (typical)

$I_F = f(V_F)$

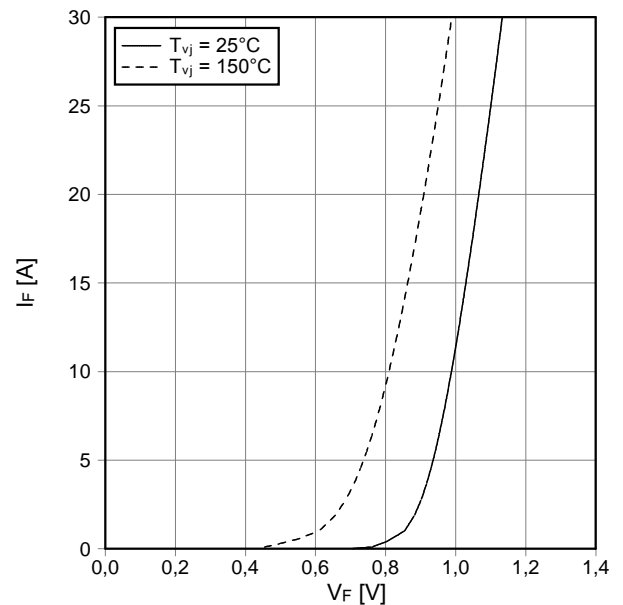

|                 |                                 |
|-----------------|---------------------------------|
| prepared by: DK | date of publication: 2009-10-30 |
| approved by: MB | revision: 2.2                   |

Vorläufige Daten  
preliminary data

Ausgangskennlinie IGBT-Brems-Chopper (typisch)  
output characteristic IGBT-brake-chopper (typical)  
 $I_C = f(V_{CE})$   
 $V_{GE} = 15\text{ V}$

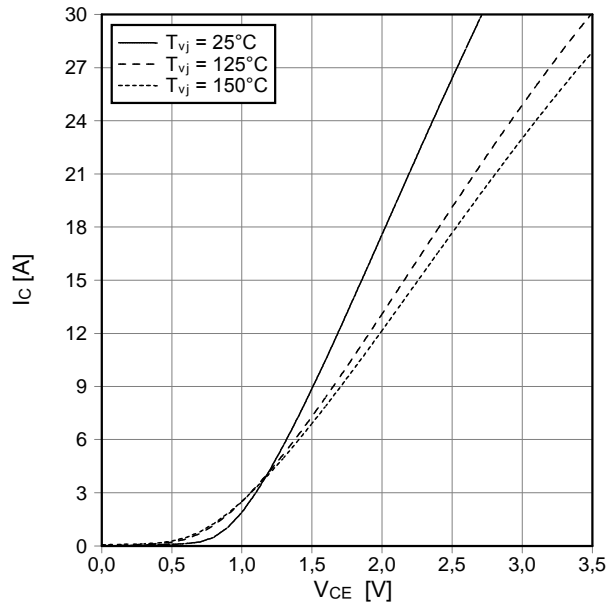

Durchlasskennlinie der Diode-Brems-Chopper (typisch)  
forward characteristic of Diode-brake-chopper (typical)  
 $I_F = f(V_F)$

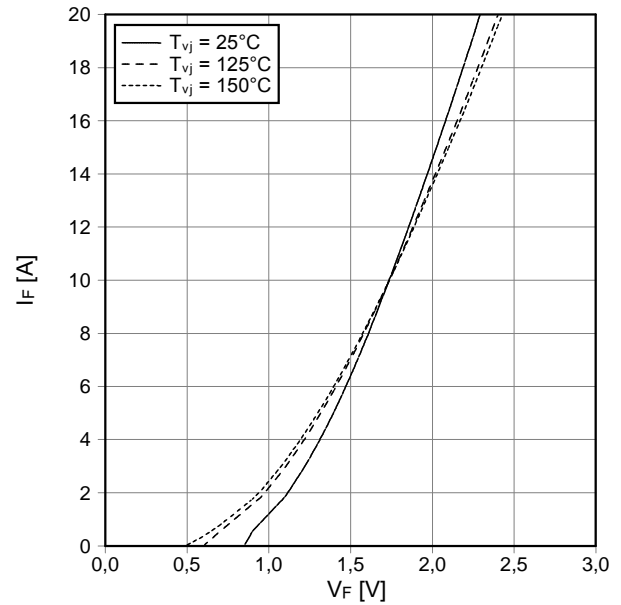

NTC-Temperaturkennlinie (typisch)  
NTC-temperature characteristic (typical)  
 $R = f(T)$

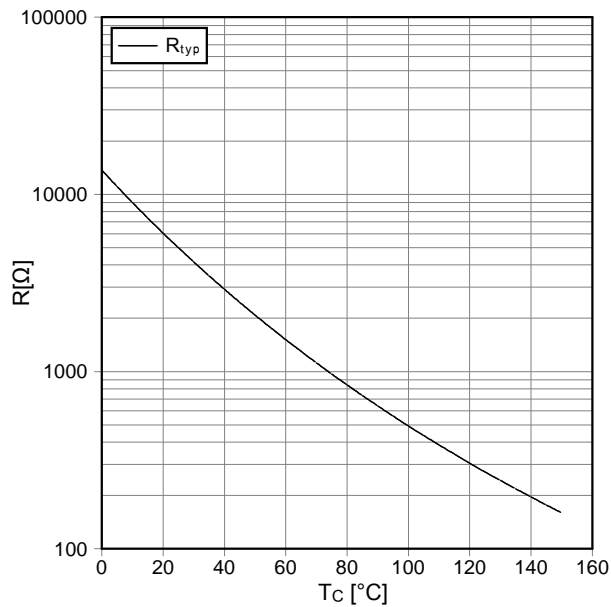

|                 |                                 |
|-----------------|---------------------------------|
| prepared by: DK | date of publication: 2009-10-30 |
| approved by: MB | revision: 2.2                   |

**Schaltplan / circuit diagram**

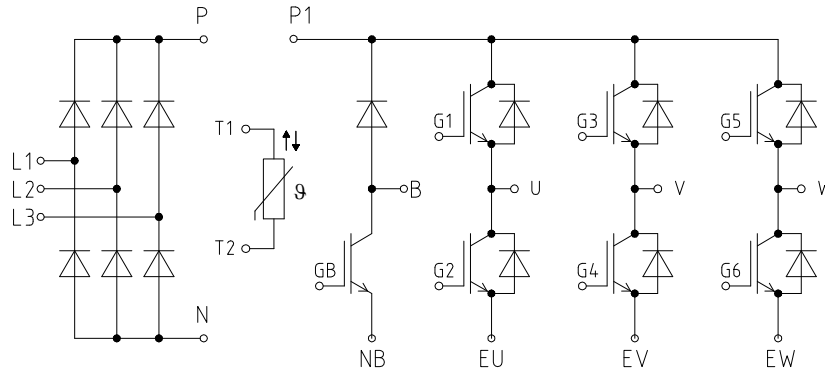

**Gehäuseabmessungen / package outlines**

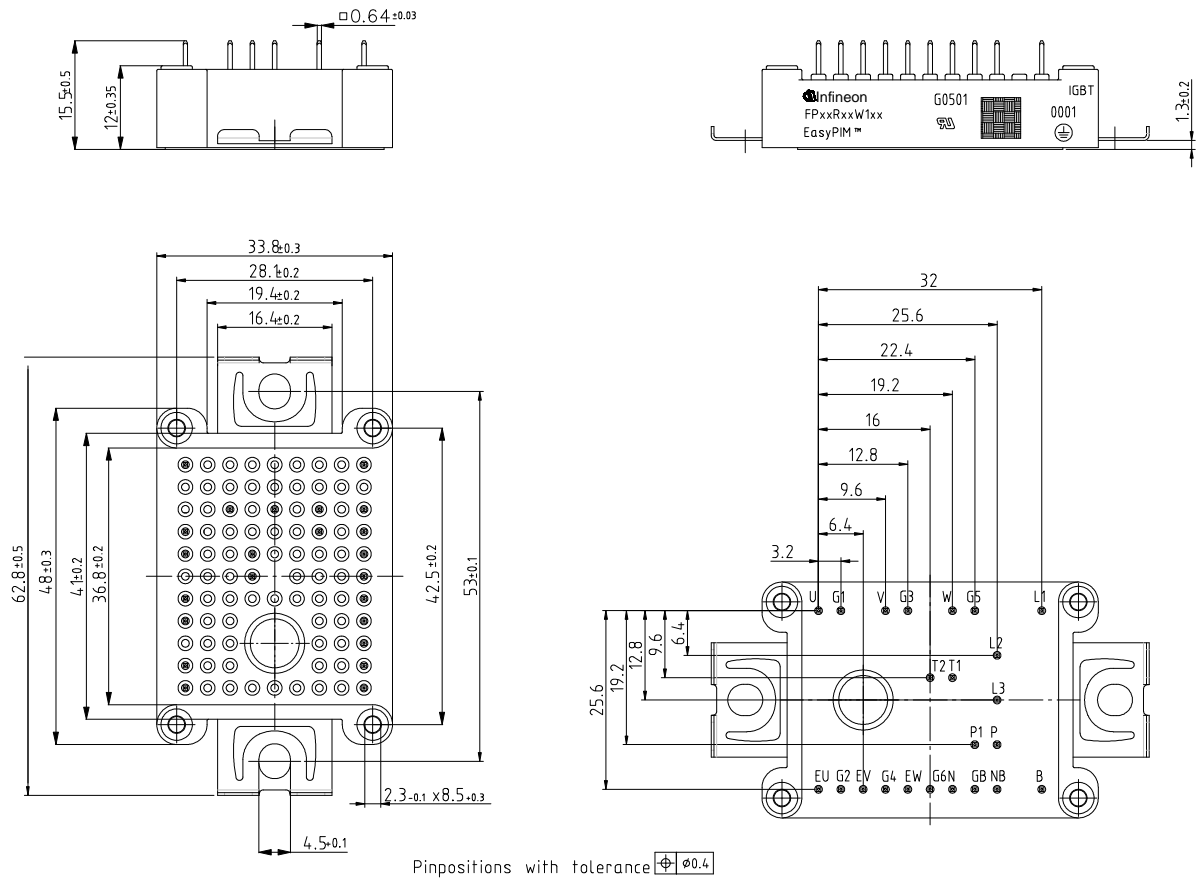

|                 |                                 |
|-----------------|---------------------------------|
| prepared by: DK | date of publication: 2009-10-30 |
| approved by: MB | revision: 2.2                   |



**Nutzungsbedingungen**

Die in diesem Produktdatenblatt enthaltenen Daten sind ausschließlich für technisch geschultes Fachpersonal bestimmt. Die Beurteilung der Eignung dieses Produktes für Ihre Anwendung sowie die Beurteilung der Vollständigkeit der bereitgestellten Produktdaten für diese Anwendung obliegt Ihnen bzw. Ihren technischen Abteilungen.

In diesem Produktdatenblatt werden diejenigen Merkmale beschrieben, für die wir eine liefervertragliche Gewährleistung übernehmen. Eine solche Gewährleistung richtet sich ausschließlich nach Maßgabe der im jeweiligen Liefervertrag enthaltenen Bestimmungen. Garantien jeglicher Art werden für das Produkt und dessen Eigenschaften keinesfalls übernommen.

Sollten Sie von uns Produktinformationen benötigen, die über den Inhalt dieses Produktdatenblatts hinausgehen und insbesondere eine spezifische Verwendung und den Einsatz dieses Produktes betreffen, setzen Sie sich bitte mit dem für Sie zuständigen Vertriebsbüro in Verbindung (siehe [www.infineon.com](http://www.infineon.com), Vertrieb&Kontakt). Für Interessenten halten wir Application Notes bereit.

Aufgrund der technischen Anforderungen könnte unser Produkt gesundheitsgefährdende Substanzen enthalten. Bei Rückfragen zu den in diesem Produkt jeweils enthaltenen Substanzen setzen Sie sich bitte ebenfalls mit dem für Sie zuständigen Vertriebsbüro in Verbindung.

Sollten Sie beabsichtigen, das Produkt in Anwendungen der Luftfahrt, in gesundheits- oder lebensgefährdenden oder lebenserhaltenden Anwendungsbereichen einzusetzen, bitten wir um Mitteilung. Wir weisen darauf hin, dass wir für diese Fälle

- die gemeinsame Durchführung eines Risiko- und Qualitätsassessments;
- den Abschluss von speziellen Qualitätssicherungsvereinbarungen;
- die gemeinsame Einführung von Maßnahmen zu einer laufenden Produktbeobachtung dringend empfehlen und gegebenenfalls die Belieferung von der Umsetzung solcher Maßnahmen abhängig machen.

Soweit erforderlich, bitten wir Sie, entsprechende Hinweise an Ihre Kunden zu geben.

Inhaltliche Änderungen dieses Produktdatenblatts bleiben vorbehalten.

**Terms & Conditions of usage**

The data contained in this product data sheet is exclusively intended for technically trained staff. You and your technical departments will have to evaluate the suitability of the product for the intended application and the completeness of the product data with respect to such application.

This product data sheet is describing the characteristics of this product for which a warranty is granted. Any such warranty is granted exclusively pursuant the terms and conditions of the supply agreement. There will be no guarantee of any kind for the product and its characteristics.

Should you require product information in excess of the data given in this product data sheet or which concerns the specific application of our product, please contact the sales office, which is responsible for you (see [www.infineon.com](http://www.infineon.com), sales&contact). For those that are specifically interested we may provide application notes.

Due to technical requirements our product may contain dangerous substances. For information on the types in question please contact the sales office, which is responsible for you.

Should you intend to use the Product in aviation applications, in health or live endangering or life support applications, please notify. Please note, that for any such applications we urgently recommend

- to perform joint Risk and Quality Assessments;
- the conclusion of Quality Agreements;
- to establish joint measures of an ongoing product survey, and that we may make delivery depended on the realization of any such measures.

If and to the extent necessary, please forward equivalent notices to your customers.

Changes of this product data sheet are reserved.

|                 |                                 |
|-----------------|---------------------------------|
| prepared by: DK | date of publication: 2009-10-30 |
| approved by: MB | revision: 2.2                   |