

SKM 150GB123D

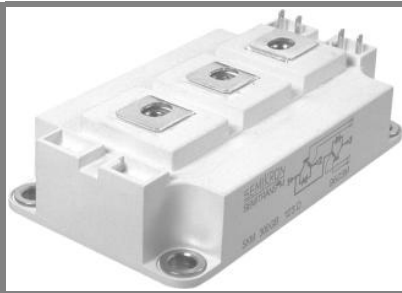

SEMITRANS® 3

IGBT Modules

SKM 150GB123D

SKM 150GAL123D

Features

- MOS input (voltage controlled)
- N channel, Homogeneous Si
- Low inductance case
- Very low tail current with low temperature dependence
- High short circuit capability, self limiting to $6 \times I_{Cnom}$
- Latch-up free
- Fast & soft inverse CAL diodes
- Isolated copper baseplate using DCB Direct Copper Bonding
- Large clearance (12 mm) and creepage distances (20 mm)

Typical Applications*

- AC inverter drives
- UPS

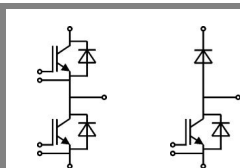

GB

GAL

Absolute Maximum Ratings		$T_c = 25^\circ\text{C}$, unless otherwise specified		
Symbol	Conditions	Values	Units	
IGBT				
V_{CES}	$T_j = 25^\circ\text{C}$	1200	V	
I_C	$T_j = 150^\circ\text{C}$	$T_{case} = 25^\circ\text{C}$	150	A
		$T_{case} = 80^\circ\text{C}$	110	A
I_{CRM}	$I_{CRM} = 2 \times I_{Cnom}$	200	A	
V_{GES}		± 20	V	
t_{psc}	$V_{CC} = 600\text{ V}; V_{GE} \leq 20\text{ V}; T_j = 125^\circ\text{C}$ $V_{CES} < 1200\text{ V}$	10	μs	

Inverse Diode		$T_c = 25^\circ\text{C}$, unless otherwise specified		
Symbol	Conditions	Values	Units	
I_F	$T_j = 150^\circ\text{C}$	$T_{case} = 25^\circ\text{C}$	150	A
		$T_{case} = 80^\circ\text{C}$	100	A
I_{FRM}	$I_{FRM} = 2 \times I_{Fnom}$	200	A	
I_{FSM}	$t_p = 10\text{ ms}; \text{sin.}$	$T_j = 150^\circ\text{C}$	1100	A

Freewheeling Diode		$T_c = 25^\circ\text{C}$, unless otherwise specified		
Symbol	Conditions	Values	Units	
I_F	$T_j = 150^\circ\text{C}$	$T_{case} = 25^\circ\text{C}$	200	A
		$T_{case} = 80^\circ\text{C}$	135	A
I_{FRM}		300	A	
I_{FSM}	$t_p = 10\text{ ms}; \text{sin.}$	$T_j = 150^\circ\text{C}$	1440	A

Module		$T_c = 25^\circ\text{C}$, unless otherwise specified	
Symbol	Conditions	Values	Units
$I_{t(RMS)}$		500	A
T_{vj}		-40 ... +150	$^\circ\text{C}$
T_{stg}		-40 ... +125	$^\circ\text{C}$
V_{isol}	AC, 1 min.	2500	V

Characteristics		$T_c = 25^\circ\text{C}$, unless otherwise specified			
Symbol	Conditions	min.	typ.	max.	Units
IGBT					
$V_{GE(th)}$	$V_{GE} = V_{CE}, I_C = 4\text{ mA}$	4,5	5,5	6,5	V
I_{CES}	$V_{GE} = 0\text{ V}, V_{CE} = V_{CES}$	$T_j = 25^\circ\text{C}$	0,1	0,3	mA
		$T_j = 125^\circ\text{C}$			mA
V_{CE0}		$T_j = 25^\circ\text{C}$	1,4	1,6	V
		$T_j = 125^\circ\text{C}$	1,6	1,8	V
r_{CE}	$V_{GE} = 15\text{ V}$	$T_j = 25^\circ\text{C}$	11	14	$\text{m}\Omega$
		$T_j = 125^\circ\text{C}$	15	19	$\text{m}\Omega$
$V_{CE(sat)}$	$I_{Cnom} = 100\text{ A}, V_{GE} = 15\text{ V}$	$T_j = ^\circ\text{C}_{chiplev.}$	2,5	3	V
C_{res}	$V_{CE} = 25, V_{GE} = 0\text{ V}$	$f = 1\text{ MHz}$	6,5	8,5	nF
C_{oes}			1	1,5	nF
C_{res}			0,5	0,6	nF
Q_G	$V_{GE} = -8\text{ V} - +20\text{ V}$		1000		nC
R_{Gint}	$T_j = ^\circ\text{C}$		2,5		Ω
$t_{d(on)}$	$R_{Gon} = 6,8\ \Omega$	$V_{CC} = 600\text{ V}$ $I_C = 100\text{ A}$	160	320	ns
t_r			80	160	ns
E_{on}	$R_{Goff} = 6,8\ \Omega$	$T_j = 125^\circ\text{C}$ $V_{GE} = \pm 15\text{ V}$	13		mJ
$t_{d(off)}$			400	520	ns
t_f			70	100	ns
E_{off}			11		mJ
$R_{th(j-c)}$	per IGBT			0,15	K/W

SKM 150GB123D

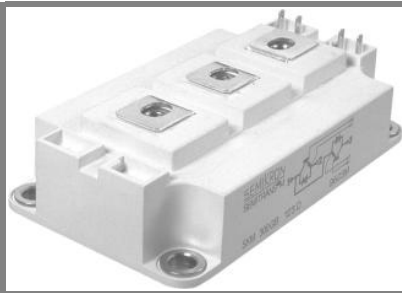

SEMITRANS® 3

IGBT Modules

SKM 150GB123D

SKM 150GAL123D

Features

- MOS input (voltage controlled)
- N channel, Homogeneous Si
- Low inductance case
- Very low tail current with low temperature dependence
- High short circuit capability, self limiting to $6 \times I_{cnom}$
- Latch-up free
- Fast & soft inverse CAL diodes
- Isolated copper baseplate using DCB Direct Copper Bonding
- Large clearance (12 mm) and creepage distances (20 mm)

Typical Applications*

- AC inverter drives
- UPS

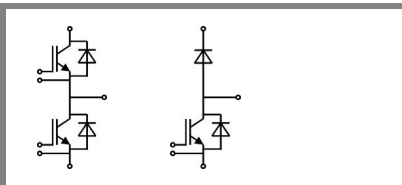

GB

GAL

Characteristics

Symbol	Conditions	min.	typ.	max.	Units
Inverse Diode					
$V_F = V_{EC}$	$I_{Fnom} = 100 \text{ A}; V_{GE} = 0 \text{ V}$	$T_j = 25 \text{ }^\circ\text{C}_{chiplev.}$	2	2,5	V
		$T_j = 125 \text{ }^\circ\text{C}_{chiplev.}$	1,8		V
V_{F0}		$T_j = 25 \text{ }^\circ\text{C}$	1,1	1,2	V
		$T_j = 125 \text{ }^\circ\text{C}$			V
r_F		$T_j = 25 \text{ }^\circ\text{C}$	9	13	mΩ
		$T_j = 125 \text{ }^\circ\text{C}$			mΩ
I_{RRM}	$I_F = 100 \text{ A}$	$T_j = 125 \text{ }^\circ\text{C}$	50		A
Q_{rr}	$di/dt = 1000 \text{ A}/\mu\text{s}$		5		μC
E_{rr}	$V_{GE} = 0 \text{ V}; V_{CC} = 600 \text{ V}$				mJ
$R_{th(j-c)D}$	per diode			0,3	K/W
Freewheeling Diode					
$V_F = V_{EC}$	$I_{Fnom} = 150 \text{ A}; V_{GE} = 0 \text{ V}$	$T_j = 25 \text{ }^\circ\text{C}_{chiplev.}$	2	2,5	V
		$T_j = 125 \text{ }^\circ\text{C}_{chiplev.}$	1,8		V
V_{F0}		$T_j = 25 \text{ }^\circ\text{C}$	1,1	1,2	V
		$T_j = 125 \text{ }^\circ\text{C}$			V
r_F		$T_j = 25 \text{ }^\circ\text{C}$	6	8,7	V
		$T_j = 125 \text{ }^\circ\text{C}$			V
I_{RRM}	$I_F = 100 \text{ A}$	$T_j = 25 \text{ }^\circ\text{C}$	40		A
Q_{rr}			5		μC
E_{rr}	$V_{GE} = 0 \text{ V}; V_{CC} = 600 \text{ V}$				mJ
$R_{th(j-c)FD}$	per diode			0,25	K/W
Module					
L_{CE}			15	20	nH
R_{CC+EE}	res., terminal-chip	$T_{case} = 25 \text{ }^\circ\text{C}$	0,35		mΩ
		$T_{case} = 125 \text{ }^\circ\text{C}$	0,5		mΩ
$R_{th(c-s)}$	per module			0,038	K/W
M_s	to heat sink M6		3	5	Nm
M_t	to terminals M6		2,5	5	Nm
w				325	g

This is an electrostatic discharge sensitive device (ESDS), international standard IEC 60747-1, Chapter IX.

* The specifications of our components may not be considered as an assurance of component characteristics. Components have to be tested for the respective application. Adjustments may be necessary. The use of SEMIKRON products in life support appliances and systems is subject to prior specification and written approval by SEMIKRON. We therefore strongly recommend prior consultation of our personal.

SKM 150GB123D

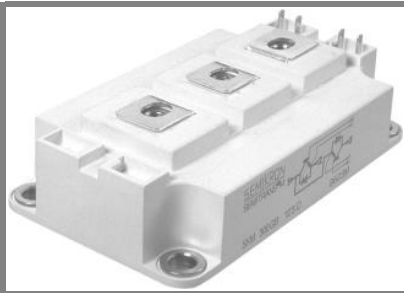

SEMITRANS® 3

IGBT Modules

SKM 150GB123D

SKM 150GAL123D

Features

- MOS input (voltage controlled)
- N channel, Homogeneous Si
- Low inductance case
- Very low tail current with low temperature dependence
- High short circuit capability, self limiting to $6 \times I_{cnom}$
- Latch-up free
- Fast & soft inverse CAL diodes
- Isolated copper baseplate using DCB Direct Copper Bonding
- Large clearance (12 mm) and creepage distances (20 mm)

Typical Applications*

- AC inverter drives
- UPS

Z_{th}		Values	Units
Symbol	Conditions		
$Z_{th(j-c)I}$			
R_{θ}	$i = 1$	105	mk/W
R_{θ}	$i = 2$	35	mk/W
R_{θ}	$i = 3$	8	mk/W
R_{θ}	$i = 4$	2	mk/W
τ_{θ}	$i = 1$	0,03	s
τ_{θ}	$i = 2$	0,03	s
τ_{θ}	$i = 3$	0,0014	s
τ_{θ}	$i = 4$	0,0001	s
$Z_{th(j-c)D}$			
R_{θ}	$i = 1$	210	mk/W
R_{θ}	$i = 2$	70	mk/W
R_{θ}	$i = 3$	16	mk/W
R_{θ}	$i = 4$	4	mk/W
τ_{θ}	$i = 1$	0,0623	s
τ_{θ}	$i = 2$	0,0083	s
τ_{θ}	$i = 3$	0,003	s
τ_{θ}	$i = 4$	0,0002	s

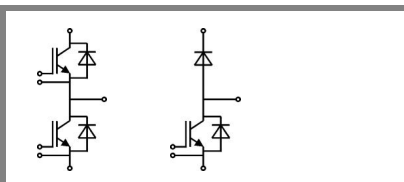

GB

GAL

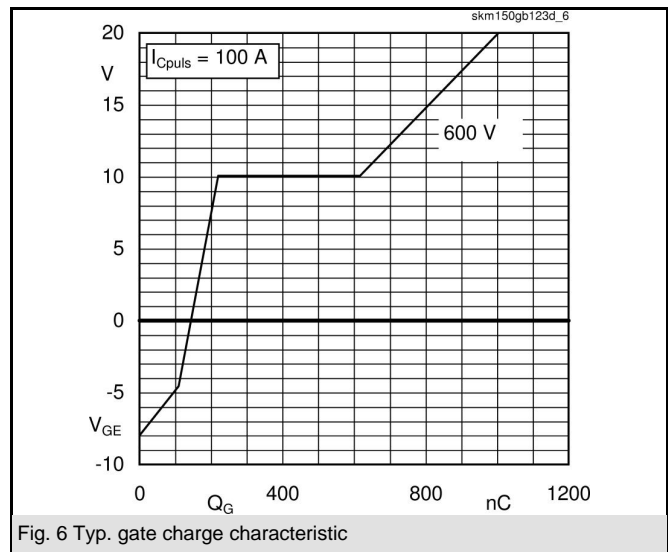
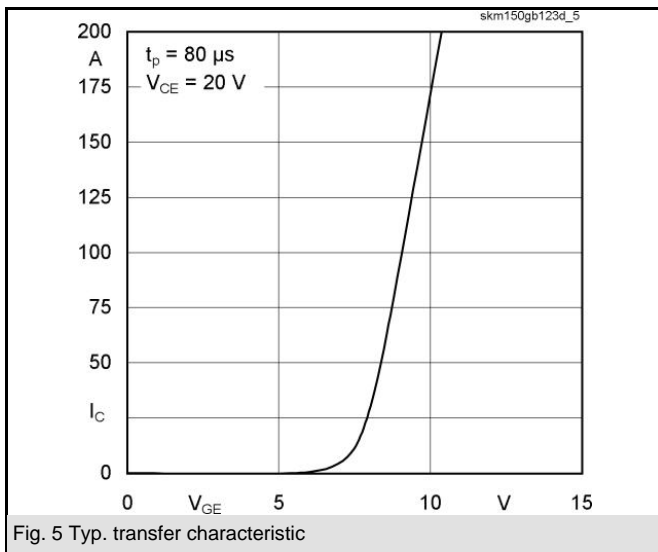
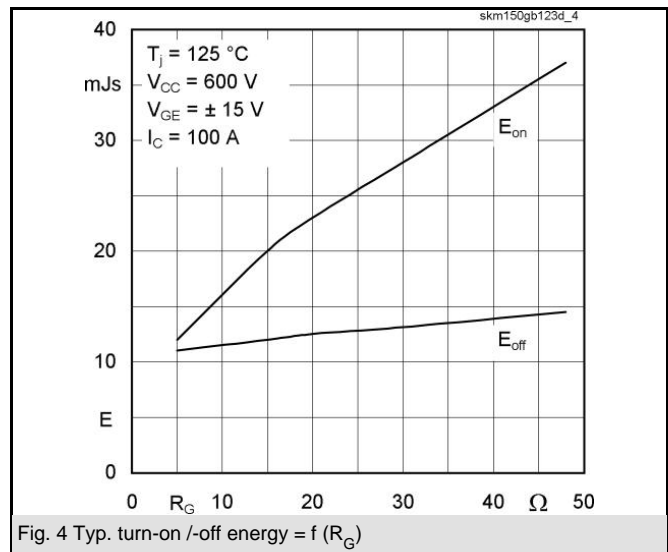
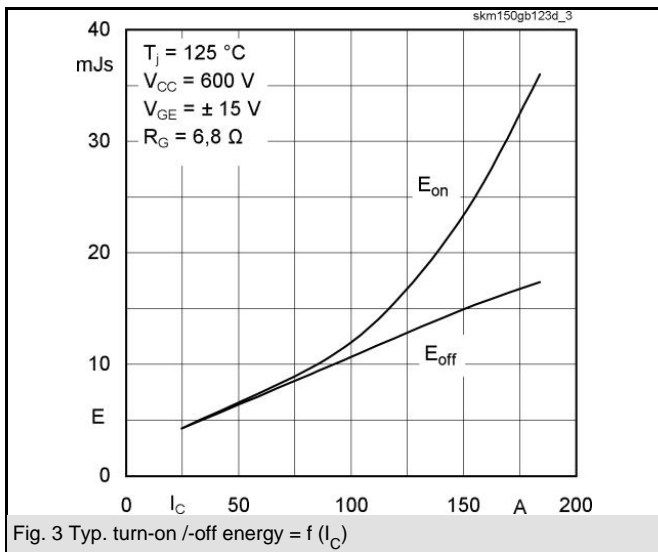
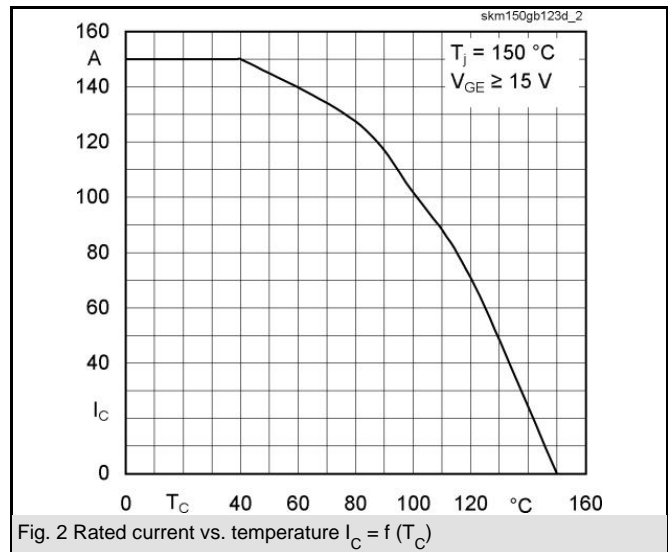
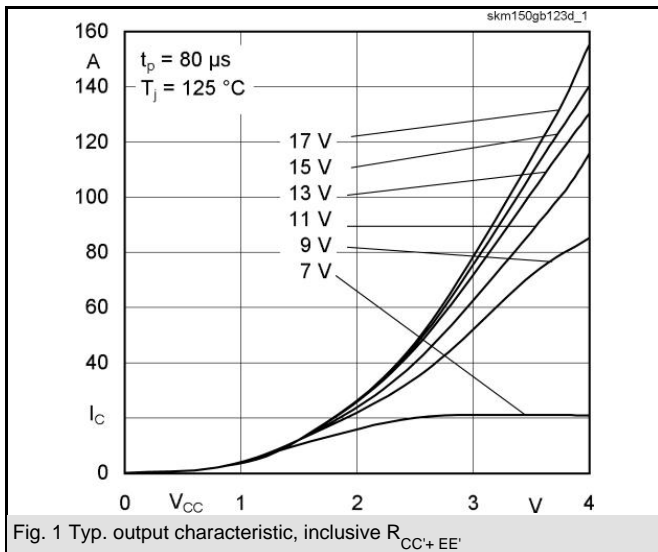

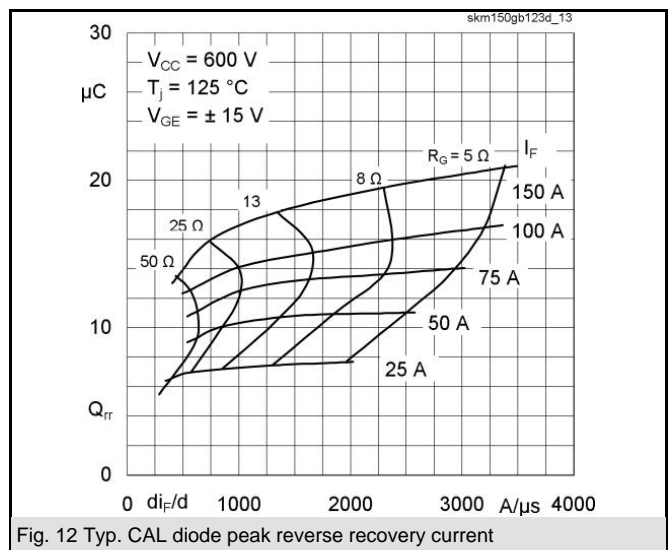
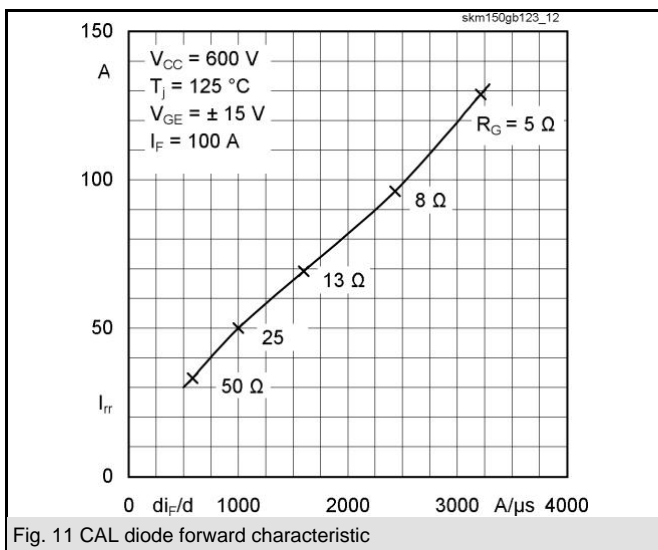
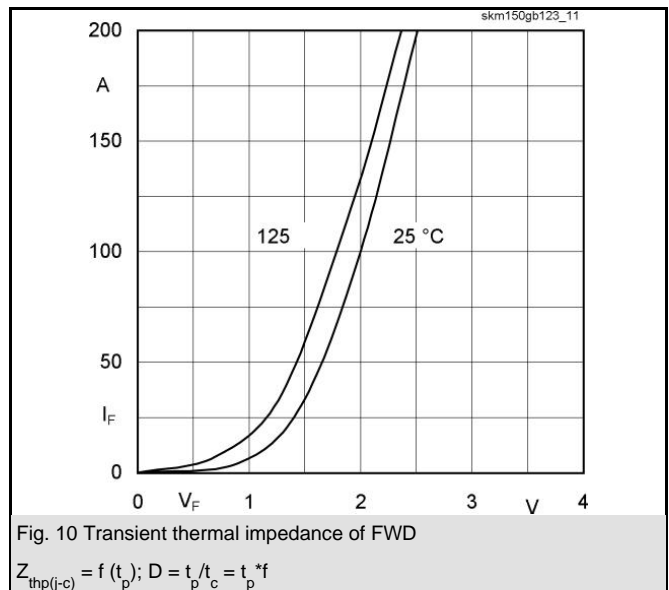
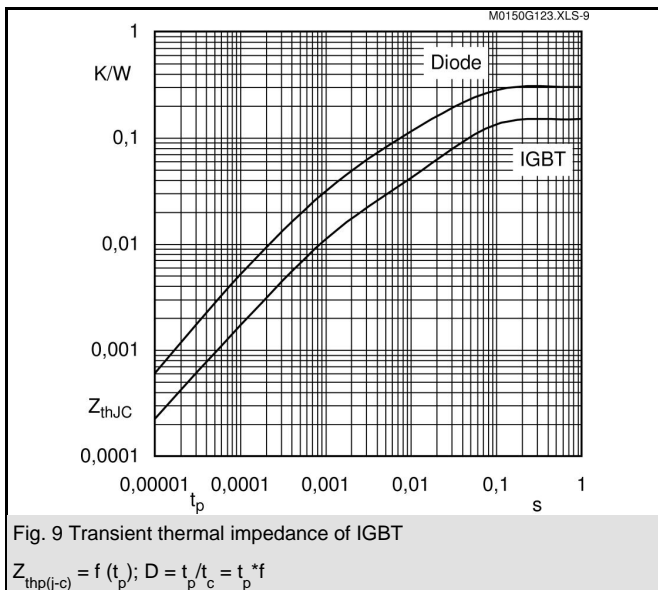
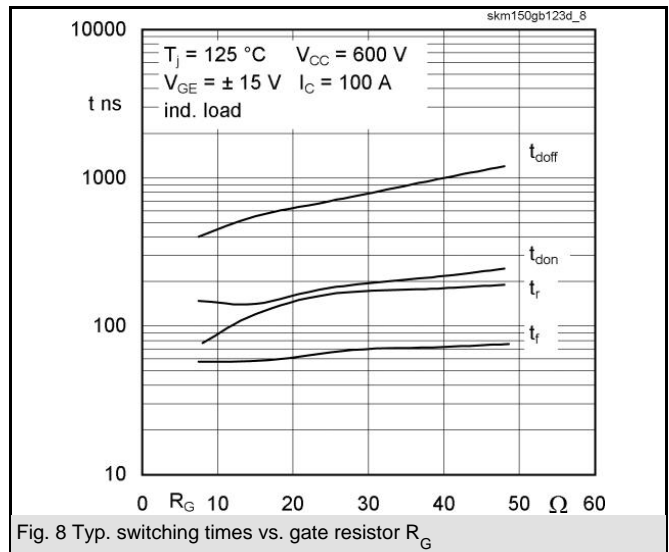
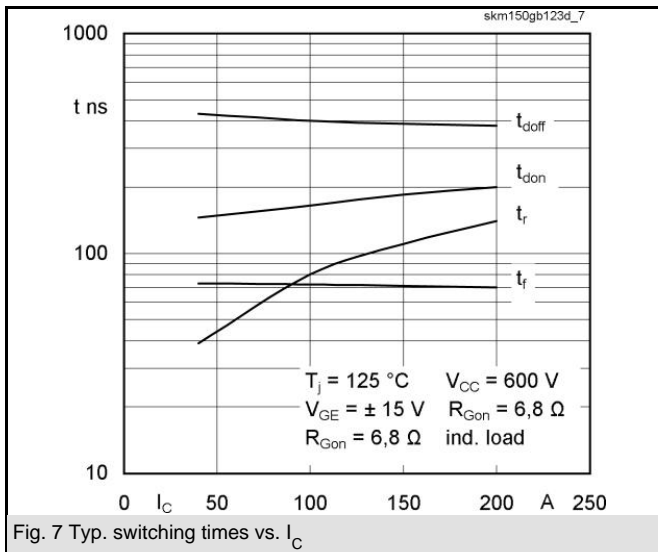

SKM 150GB123D

UL Recognized

CASED56

File no. E63 532

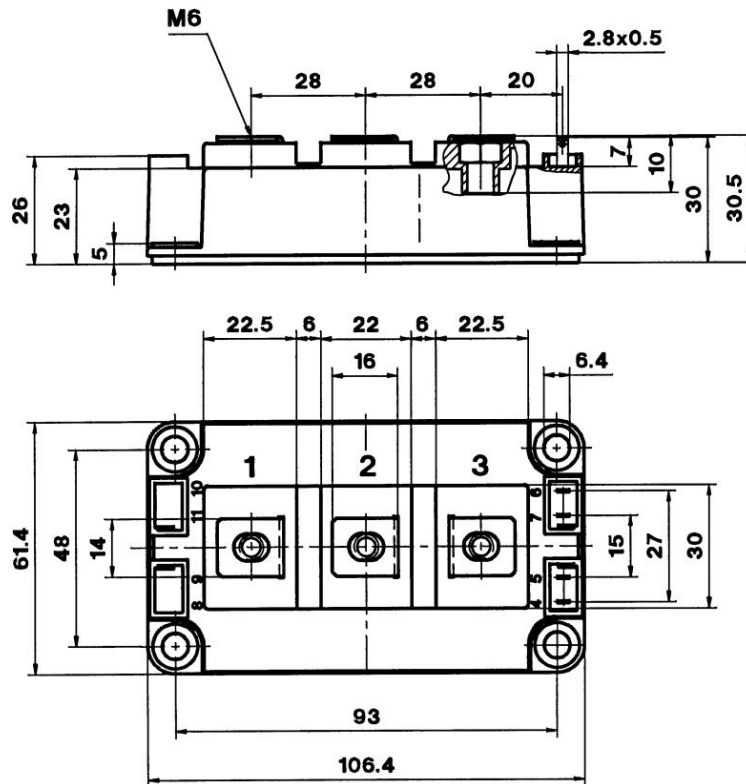

Case D 56

