

Ultrafast Plastic Rectifier

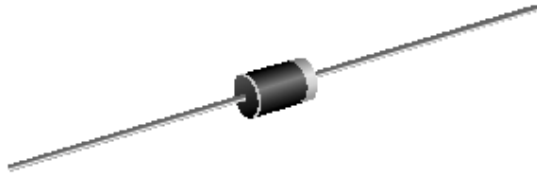

Features:

- Plastic package.
- Ideally suited for use in very high frequency switching power supplies, inverters and as free wheeling diodes.
- Ultrafast recovery time for high efficiency.
- Excellent high temperature switching.
- Soft recovery characteristics.
- Glass passivated junction.
- High temperature soldering guaranteed:
250°C/10 seconds, 0.375 inch (9.5mm) lead length, 5lbs. (2.3kg) tension.

DO-201AD

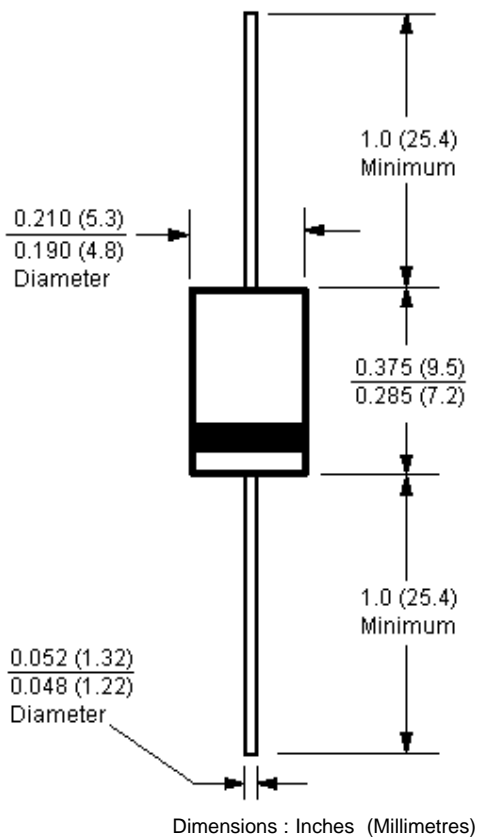

Mechanical Data:

Case	: JEDEC DO-201AD moulded plastic body over passivated chip.
Terminals	: Plated axial leads, solderable per MIL-STD-750, Method 2026.
Polarity	: Colour band denotes cathode end.
Mounting position	: Any.
Weight	: 0.045 oz., 1.2 grams.

Maximum Ratings and Thermal Characteristics

Rating at 25°C ambient temperature unless otherwise specified.

Parameter	Symbols	UG4D	Units
Maximum Repetitive Peak Reverse Voltage	V_{RRM}	200	V
Maximum RMS Voltage	V_{RMS}	140	
Maximum DC Blocking Voltage	V_{DC}	200	
Maximum Average Forward Rectified Current at 0.375 inch (9.5mm) Lead Length at $T_L = 75^\circ\text{C}$	$I_F (AV)$	4.0	A
Peak Forward Surge Current 8.3ms Single Half Sine-wave Superimposed on Rated Load (JEDEC Method) at $T_L = 75^\circ\text{C}$	I_{FSM}	150	
Typical Thermal Resistance (NOTE 1)	$R_{\theta JA}$	25	$^\circ\text{C}/\text{W}$
Operating Junction and Storage Temperature Range	T_J, T_{STG}	-55 to +150°C	$^\circ\text{C}$

Electrical Characteristics

Rating at 25°C ambient temperature unless otherwise specified.

Parameter	Symbols	Value	Units
Maximum Instantaneous Forward Voltage at 4.0A (NOTE 2)	V_F	0.95	V
Maximum DC Reverse Current at Rated DC Blocking Voltage	I_R	$T_A = 25^\circ\text{C}$ 5.0	μA
		$T_A = 100^\circ\text{C}$ 300	
Maximum Reverse Recovery Time at $I_F = 0.5\text{A}$, $I_R = 1.0\text{A}$, $I_{rr} = 0.25\text{A}$	t_{rr}	20	ns
Maximum Reverse Recovery Time at $I_F = 4.0\text{A}$, $di/dt = 50\text{A}/\mu\text{s}$, $V_R = 30\text{V}$, $I_{rr} = 10\% I_{RM}$		$T_J = 25^\circ\text{C}$ 30	
		$T_J = 100^\circ\text{C}$ 50	
Maximum Recovered Stored Charge $I_F = 4.0\text{A}$, $di/dt = 50\text{A}/\mu\text{s}$, $V_R = 30\text{V}$, $I_{rr} = 10\% I_{RM}$	Q_{rr}	$T_J = 25^\circ\text{C}$ 15	nC
		$T_J = 100^\circ\text{C}$ 30	
Typical Junction Capacitance at 4V, 1MHz	C_J	20	pF

Notes:

- (1) Thermal Resistance from Junction to Ambient at 0.375 inch (9.5mm) Lead Length.
- (2) Pulse Test: 300 μs Pulse Width, 1% duty Cycle.

Ratings and Characteristic Curves ($T_A = 25^\circ\text{C}$ unless otherwise noted)

Forward Current Derating Curves

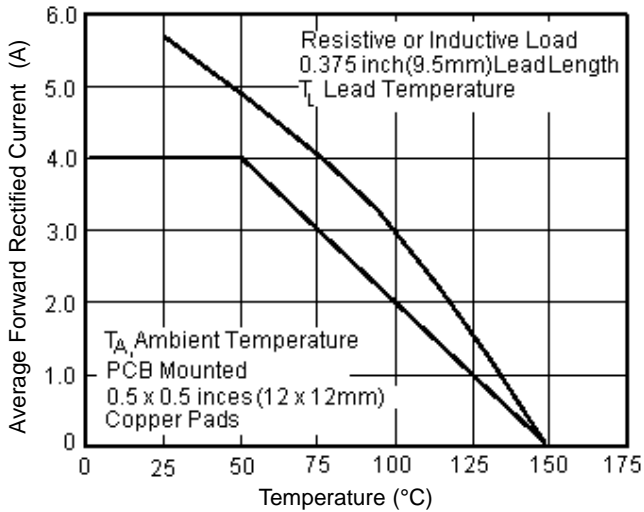

Maximum Non-Repetitive Peak Forward Surge Current

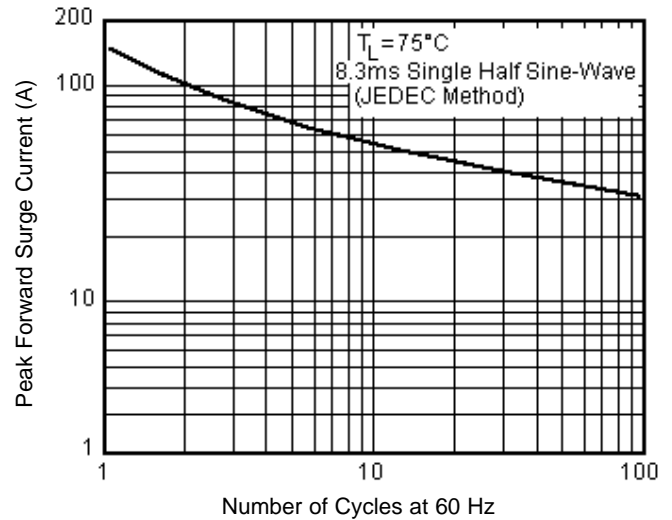

Typical Instantaneous Forward Characteristics

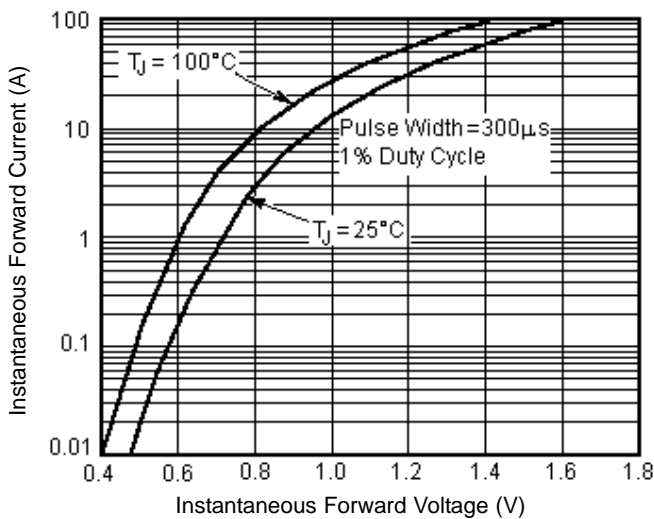

Typical Reverse Leakage Characteristics

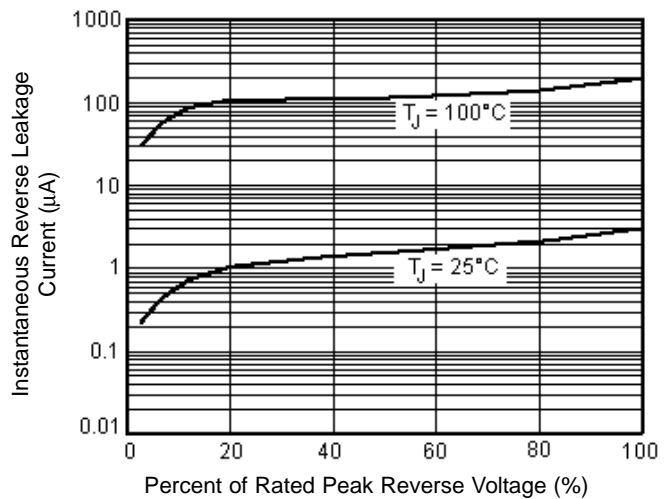

Reverse Switching Characteristics

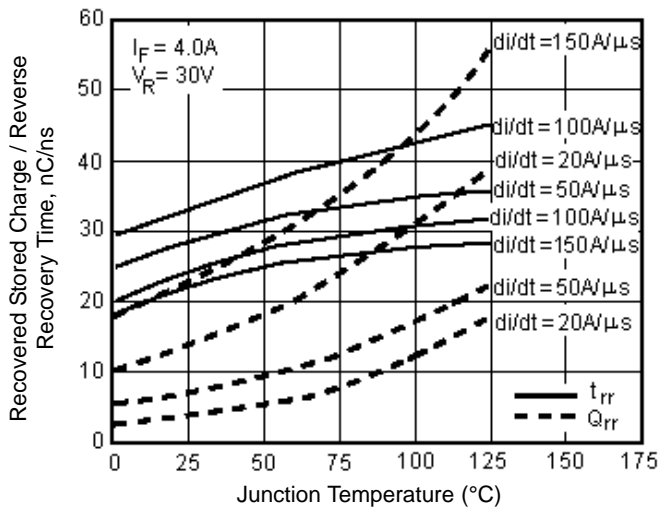

Typical Junction Capacitance

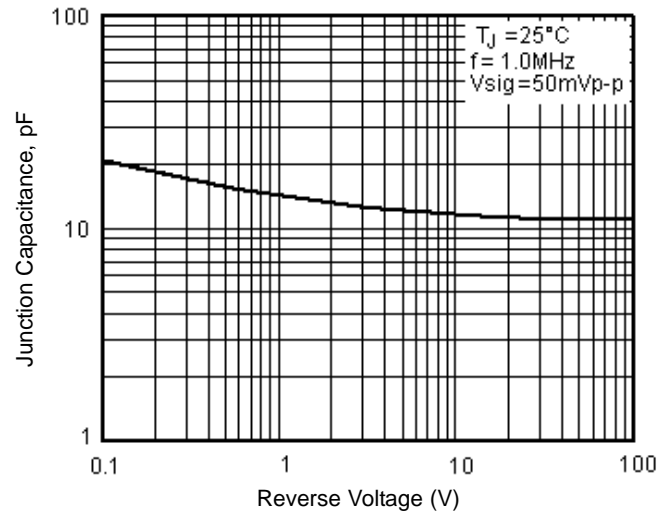

Part Number Table

Description	Part Number
Diode, Ultra-fast, 4A, 200V	UG4D

Notes:

International Sales Offices:

	AUSTRALIA - Farnell Tel No: ++61 1300 361 005 Fax No: ++61 1300 361 225		FINLAND - Farnell Tel No: ++358 9 560 7780 Fax No: ++358 9 345 5411		ITALY - Farnell Tel No: ++39 02 93 995 200 Fax No: ++39 02 93 995 300		SPAIN - Farnell Tel No: 901 20 20 80 Fax No: 901 20 20 90
	AUSTRIA - Farnell Tel No: ++43 662 2180 680 Fax No: ++43 662 2180 670		FRANCE - Farnell Tel No: ++33 474 68 99 99 Fax No: ++33 474 68 99 90		MALAYSIA - Farnell-Newark Tel No: ++60 3 7873 8000 Fax No: ++60 3 7873 7000		SWEDEN - Farnell Tel No: ++46 8 730 50 00 Fax No: ++46 8 83 52 62
	BELGIUM - Farnell Tel No: ++32 3 475 2810 Fax No: ++32 3 227 3648		GERMANY - Farnell Tel No: ++49 89 61 39 39 39 Fax No: ++49 89 613 59 01		NETHERLANDS - Farnell Tel No: ++31 30 241 7373 Fax No: ++31 30 241 7333		SWITZERLAND - Farnell Tel No: ++44 204 64 64 Fax No: ++44 204 64 54
	BRAZIL - Farnell-Newark Tel No: ++55 11 4066 9400 Fax No: ++55 11 4066 9410		HONG KONG - Farnell-Newark Tel No: ++852 2268 9888 Fax No: ++852 2268 9899		NEW ZEALAND - Farnell Tel No: 0800 90 80 80 Fax No: 0800 90 80 81		UK - Farnell Tel No: ++44 8701 200 200 Fax No: ++44 8701 200 201
	CHINA - Farnell-Newark Tel No: ++86 10 6238 5152 Fax No: ++86 10 6238 5022		HUNGARY - Farnell Tel No: ++44 870 1200 208 Fax No: ++44 870 1200 209		NORWAY - Farnell Tel No: 800 146 70 Fax No: 800 146 76		UK - CPC ++44 8701 202 530 ++44 8701 202 531
	CZECH REPUBLIC - Farnell Tel No: ++44 870 1200 208 Fax No: ++44 870 1200 209		INDIA - Farnell Tel No: ++44 870 1200 208 Fax No: ++44 870 1200 209		PORTUGAL - Farnell Tel No: ++34 93 475 8804 Fax No: ++34 93 474 5288		USA - Newark Tel No: 800 463 9275
	DENMARK - Farnell Tel No: ++45 44 53 66 44 Fax No: ++45 44 53 66 06		IRELAND - Farnell Tel No: ++353 1 830 9277 Fax No: ++353 1 830 9016		RUSSIA - Farnell Tel No: ++44 870 1200 208 Fax No: ++44 870 1200 209	export EXPORT - Farnell Tel No: ++44 8701 200 208 Fax No: ++44 8701 200 209 For enquiries from all other markets	
	ESTONIA - Farnell Tel No: ++358 9 560 7780 Fax No: ++358 9 345 5411		ISRAEL - Farnell Tel No: ++180 937 0015 Fax No: ++180 937 0014		SINGAPORE - Farnell-Newark Tel No: ++65 6788 0200 Fax No: ++65 6788 0300	http://www.farnell.com http://www.newark.com http://www.cpc.co.uk	

Disclaimer This data sheet and its contents (the "Information") belong to the Premier Farnell Group (the "Group") or are licensed to it. No licence is granted for the use of it other than for information purposes in connection with the products to which it relates. No licence of any intellectual property rights is granted. The Information is subject to change without notice and replaces all data sheets previously supplied. The Information supplied is believed to be accurate but the Group assumes no responsibility for its accuracy or completeness, any error in or omission from it or for any use made of it. Users of this data sheet should check for themselves the Information and the suitability of the products for their purpose and not make any assumptions based on information included or omitted. Liability for loss or damage resulting from any reliance on the Information or use of it (including liability resulting from negligence or where the Group was aware of the possibility of such loss or damage arising) is excluded. This will not operate to limit or restrict the Group's liability for death or personal injury resulting from its negligence. SPC Multicomp is the registered trademark of the Group. © Premier Farnell plc 2008.