

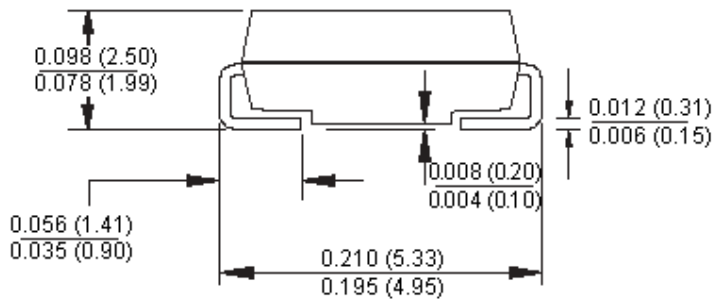

Features:

- For surface mounted application.
- Glass passivated junction chip.
- Low forward voltage drop.
- High current capability.
- Easy pick and place.
- High surge current capability.
- Plastic material.
- High temperature soldering: 260°C/10 seconds at terminals.
- High reliability grade (AEC Q101 qualified).

SMA/DO-214AC

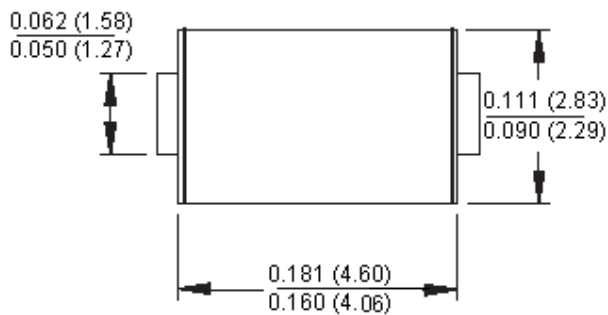

Dimensions : Inches (Millimetres)

Mechanical Data:

Cases	: Moulded plastic.
Terminals	: Pure tin plated, lead free solderable per J-STD-002B and JESD22-B102D.
Polarity	: Indicated by cathode band.
Packing	: 12mm tape per EIA STD RS-481.
Weight	: 0.064 gram.

Maximum Ratings and Electrical Characteristics

Rating at 25°C ambient temperature unless otherwise specified.

Single phase, half wave, 60Hz, resistive or inductive load.

For capacitive load, derate current by 20%.

Type Number	Symbol	S1K	S1M	Units
Maximum Recurrent Peak Reverse Voltage	V_{RRM}	800	1000	V
Maximum RMS Voltage	V_{RMS}	560	700	
Maximum DC Blocking Voltage	V_{DC}	800	1000	
Maximum Average Forward Rectified Current at $T_L = 110^\circ\text{C}$	$I_{(AV)}$	1.0		A
Peak Forward Surge Current, 8.3ms Single Half Sine-wave Superimposed on Rated Load (JEDEC method)	I_{FSM}	30		
Maximum Instantaneous Forward Voltage at 1.0A	V_F	1.1		V
Maximum DC Reverse Current at $T_A = 25^\circ\text{C}$ at Rated DC Blocking Voltage at $T_A = 125^\circ\text{C}$	I_R	1.0 50		μA μA
Maximum Reverse Recovery Time (Note 1)	T_{rr}	1.5		μs
Typical Junction Capacitance (Note 2)	C_j	12		pF
Non-Repetitive Peak Reverse Avalanche Energy at 25°C, $I_{AS} = 1\text{A}$, $L = 10\text{mH}$	E_{AS}	5		mJ
Typical Thermal Resistance (Note 3)	$R_{\theta JL}$ $R_{\theta JA}$	30 85		$^\circ\text{C/W}$
Operating Temperature Range	T_J	-55 to +150		$^\circ\text{C}$
Storage Temperature Range	T_{STG}			

Notes: 1. Reverse Recovery Test Conditions: $I_F = 0.5\text{A}$, $I_R = 1.0\text{A}$, $I_{RR} = 0.25\text{A}$.

2. Measured at 1MHz and Applied $V_R = 4.0$ Volts.

3. Measured on PC Board with 0.2 x 0.2 inches (5.0mm x 5.0mm) Copper Pad Areas.

Ratings and Characteristic Curves (S1K and S1M)

Maximum Forward Current Derating Curve

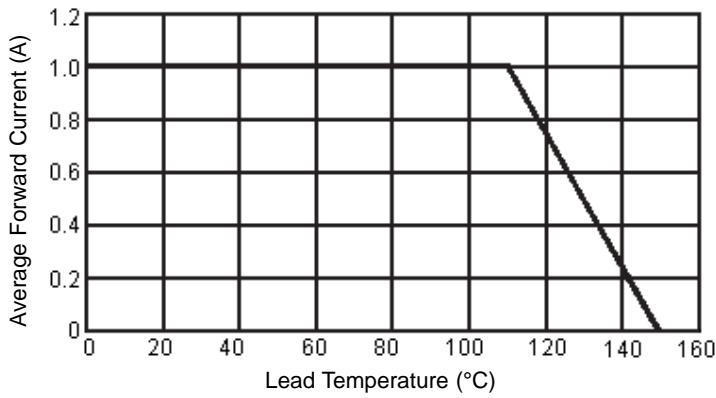

Typical Reverse Characteristics

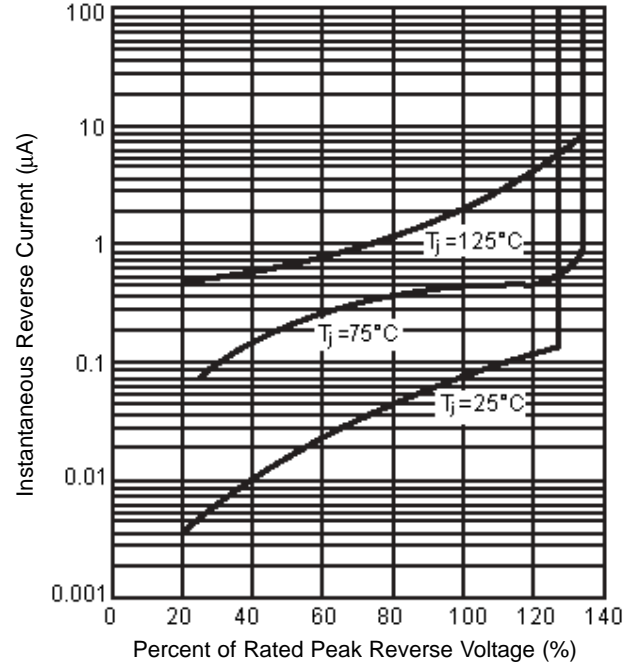

Maximum Non-Repetitive Forward Surge Current

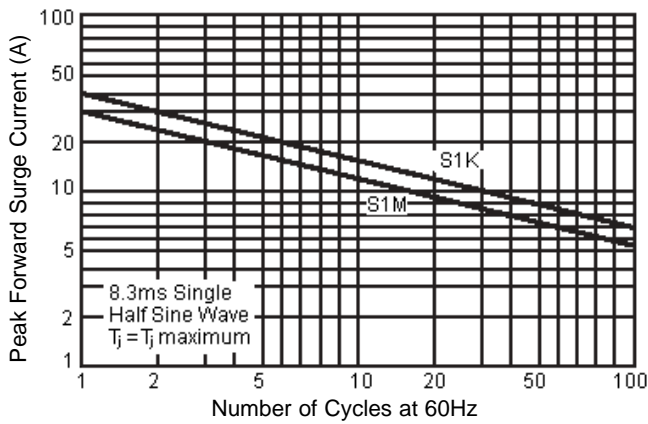

Typical Forward Characteristics

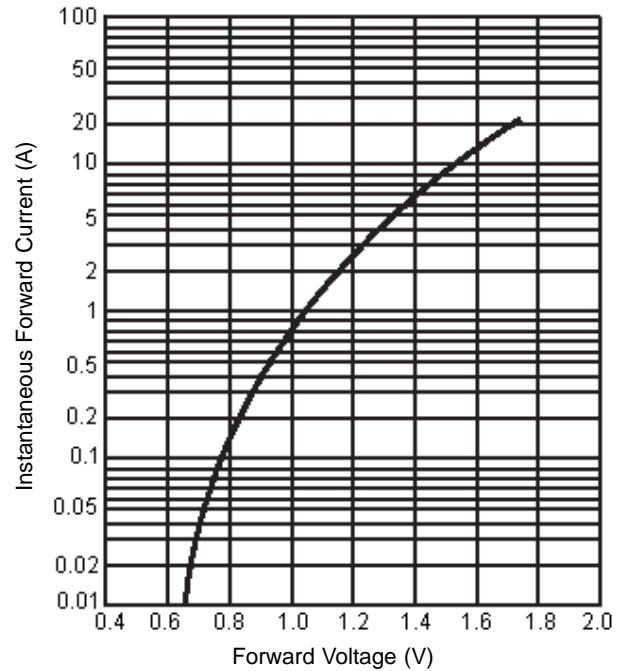

Typical Junction Capacitance

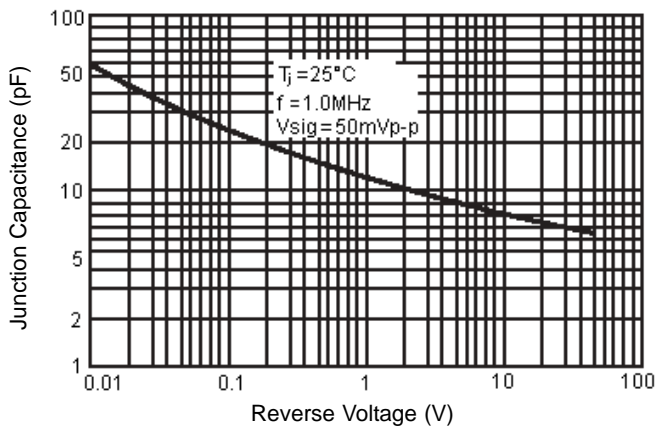

Reverse Recovery Time Characteristic and Test Circuit Diagram

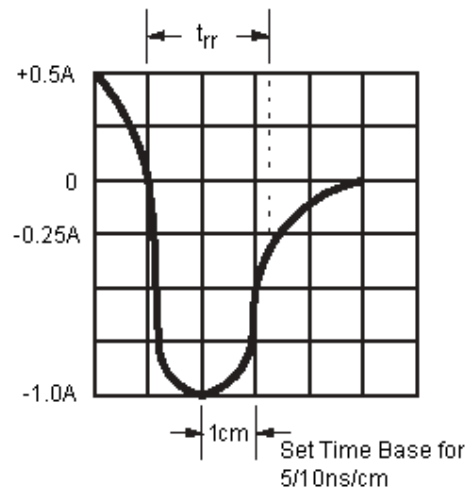
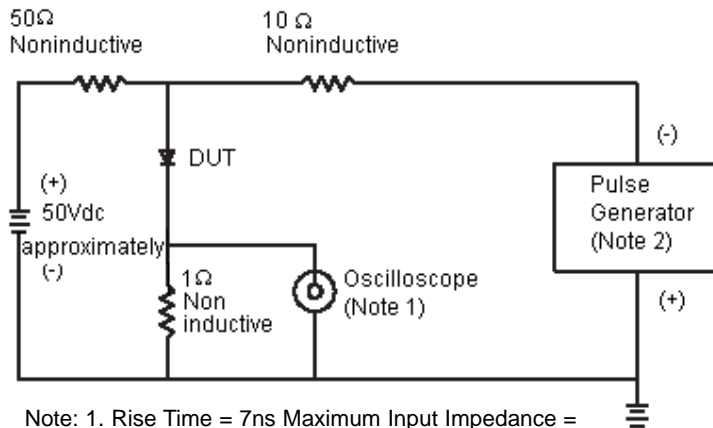

- Note: 1. Rise Time = 7ns Maximum Input Impedance = 1 megohm 22pf
 2. Rise Time = 10ns Maximum Source Impedance = 50 ohms

Part Number Table

Description	Part Number
Diode, Standard, 1A, 800V	S1K
Diode, Standard, 1A, 1000V	S1M

Notes:

International Sales Offices:

 AUSTRALIA - Farnell Tel No: ++61 1300 361 005 Fax No: ++61 1300 361 225	 FINLAND - Farnell Tel No: ++ 358 9 560 7780 Fax No: ++ 358 9 345 5411	 ITALY - Farnell Tel No: ++ 39 02 93 995 200 Fax No: ++ 39 02 93 995 300	 SPAIN - Farnell Tel No: 901 20 20 80 Fax No: 901 20 20 90
 AUSTRIA - Farnell Tel No: ++ 43 662 2180 680 Fax No: ++ 43 662 2180 670	 FRANCE - Farnell Tel No: ++ 33 474 68 99 99 Fax No: ++ 33 474 68 99 90	 MALAYSIA - Farnell-Newark Tel No: ++ 60 3 7873 8000 Fax No: ++ 60 3 7873 7000	 SWEDEN - Farnell Tel No: ++ 46 8 730 50 00 Fax No: ++ 46 8 83 52 62
 BELGIUM - Farnell Tel No: ++ 32 3 475 2810 Fax No: ++ 32 3 227 3648	 GERMANY - Farnell Tel No: ++ 49 89 61 39 39 39 Fax No: ++ 49 89 613 59 01	 NETHERLANDS - Farnell Tel No: ++ 31 30 241 7373 Fax No: ++ 31 30 241 7333	 SWITZERLAND - Farnell Tel No: ++ 44 204 64 64 Fax No: ++ 44 204 64 54
 BRAZIL - Farnell-Newark Tel No: ++ 55 11 4066 9400 Fax No: ++ 55 11 4066 9410	 HONG KONG - Farnell-Newark Tel No: ++ 852 2268 9888 Fax No: ++ 852 2268 9899	 NEW ZEALAND - Farnell Tel No: 0800 90 80 80 Fax No: 0800 90 80 81	 UK - Farnell Tel No: ++ 44 8701 200 200 Fax No: ++ 44 8701 200 201
 CHINA - Farnell-Newark Tel No: ++86 10 6238 5152 Fax No: ++86 10 6238 5022	 HUNGARY - Farnell Tel No: ++ 44 870 1200 208 Fax No: ++ 44 870 1200 209	 NORWAY - Farnell Tel No: 800 146 70 Fax No: 800 146 76	 UK - CPC ++ 44 8701 202 530 ++ 44 8701 202 531
 CZECH REPUBLIC - Farnell Tel No: ++ 44 870 1200 208 Fax No: ++ 44 870 1200 209	 INDIA - Farnell Tel No: ++ 44 870 1200 208 Fax No: ++ 44 870 1200 209	 PORTUGAL - Farnell Tel No: ++ 34 93 475 8804 Fax No: ++ 34 93 474 5288	 USA - Newark Tel No: 800 463 9275
 DENMARK - Farnell Tel No: ++ 45 44 53 66 44 Fax No: ++ 45 44 53 66 06	 IRELAND - Farnell Tel No: ++ 353 1 830 9277 Fax No: ++ 353 1 830 9016	 RUSSIA - Farnell Tel No: ++ 44 870 1200 208 Fax No: ++ 44 870 1200 209	 EXPORT - Farnell Tel No: ++ 44 8701 200 208 Fax No: ++ 44 8701 200 209 For enquiries from all other markets
 ESTONIA - Farnell Tel No: ++ 358 9 560 7780 Fax No: ++ 358 9 345 5411	 ISRAEL - Farnell Tel No: ++ 180 937 0015 Fax No: ++ 180 937 0014	 SINGAPORE - Farnell-Newark Tel No: ++ 65 6788 0200 Fax No: ++ 65 6788 0300	http://www.farnell.com http://www.newark.com http://www.cpc.co.uk

Disclaimer This data sheet and its contents (the "Information") belong to the Premier Farnell Group (the "Group") or are licensed to it. No licence is granted for the use of it other than for information purposes in connection with the products to which it relates. No licence of any intellectual property rights is granted. The Information is subject to change without notice and replaces all data sheets previously supplied. The Information supplied is believed to be accurate but the Group assumes no responsibility for its accuracy or completeness, any error in or omission from it or for any use made of it. Users of this data sheet should check for themselves the Information and the suitability of the products for their purpose and not make any assumptions based on information included or omitted. Liability for loss or damage resulting from any reliance on the Information or use of it (including liability resulting from negligence or where the Group was aware of the possibility of such loss or damage arising) is excluded. This will not operate to limit or restrict the Group's liability for death or personal injury resulting from its negligence. SPC Multicomp is the registered trademark of the Group. © Premier Farnell plc 2008.