

## Ultrafast Soft Recovery Diode, 60 A FRED Pt®

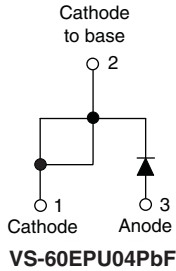

TO-247AC modified



TO-247AC

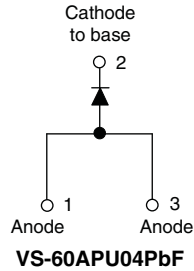

### FEATURES

- Ultrafast recovery time
- Low forward voltage drop
- 175 °C operating junction temperature
- Compliant to RoHS Directive 2002/95/EC
- Designed and qualified for industrial level



RoHS COMPLIANT

### BENEFITS

- Reduced RFI and EMI
- Higher frequency operation
- Reduced snubbing
- Reduced parts count

### DESCRIPTION/APPLICATIONS

These diodes are optimized to reduce losses and EMI/RFI in high frequency power conditioning systems. The softness of the recovery eliminates the need for a snubber in most applications. These devices are ideally suited for HF welding, power converters and other applications where switching losses are not significant portion of the total losses.

### PRODUCT SUMMARY

Package	TO-247AC, TO-247AC modified (2 pins)
$I_{F(AV)}$	60 A
$V_R$	400 V
$V_F$ at $I_F$	1.25 V
$t_{rr}$ typ.	See Recovery table
$T_J$ max.	175 °C
Diode variation	Single die

### ABSOLUTE MAXIMUM RATINGS

PARAMETER	SYMBOL	TEST CONDITIONS	VALUES	UNITS
Cathode to anode voltage	$V_R$		400	V
Continuous forward current	$I_{F(AV)}$	$T_C = 127\text{ °C}$	60	A
Single pulse forward current	$I_{FSM}$	$T_C = 25\text{ °C}$	600	
Maximum repetitive forward current	$I_{FRM}$	Square wave, 20 kHz	120	
Operating junction and storage temperatures	$T_J, T_{Stg}$		- 55 to 175	°C

### ELECTRICAL SPECIFICATIONS ( $T_J = 25\text{ °C}$ unless otherwise specified)

PARAMETER	SYMBOL	TEST CONDITIONS	MIN.	TYP.	MAX.	UNITS
Breakdown voltage, blocking voltage	$V_{BR}, V_R$	$I_R = 100\text{ }\mu\text{A}$	400	-	-	V
Forward voltage	$V_F$	$I_F = 60\text{ A}$	-	1.05	1.25	
		$I_F = 60\text{ A}, T_J = 175\text{ °C}$	-	0.87	1.03	
		$I_F = 60\text{ A}, T_J = 125\text{ °C}$	-	0.93	1.10	
Reverse leakage current	$I_R$	$V_R = V_R$ rated	-	-	50	$\mu\text{A}$
		$T_J = 150\text{ °C}, V_R = V_R$ rated	-	-	2	mA
Junction capacitance	$C_T$	$V_R = 400\text{ V}$	-	50	-	pF
Series inductance	$L_S$	Measured lead to lead 5 mm from package body	-	3.5	-	nH

# VS-60EPU04PbF, VS-60APU04PbF



Vishay Semiconductors Ultrafast Soft Recovery Diode,  
60 A FRED Pt®

DYNAMIC RECOVERY CHARACTERISTICS (T <sub>C</sub> = 25 °C unless otherwise specified)							
PARAMETER	SYMBOL	TEST CONDITIONS	MIN.	TYP.	MAX.	UNITS	
Reverse recovery time	t <sub>rr</sub>	I <sub>F</sub> = 1 A, di <sub>F</sub> /dt = 200 A/μs, V <sub>R</sub> = 30 V	-	50	60	ns	
		T <sub>J</sub> = 25 °C	-	85	-		
		T <sub>J</sub> = 125 °C	-	145	-		
Peak recovery current	I <sub>RRM</sub>	I <sub>F</sub> = 60 A di <sub>F</sub> /dt = 200 A/μs V <sub>R</sub> = 200 V	T <sub>J</sub> = 25 °C	-	8.8	-	A
			T <sub>J</sub> = 125 °C	-	15.4	-	
Reverse recovery charge	Q <sub>rr</sub>	I <sub>F</sub> = 60 A di <sub>F</sub> /dt = 200 A/μs V <sub>R</sub> = 200 V	T <sub>J</sub> = 25 °C	-	375	-	nC
			T <sub>J</sub> = 125 °C	-	1120	-	

THERMAL - MECHANICAL SPECIFICATIONS						
PARAMETER	SYMBOL	TEST CONDITIONS	MIN.	TYP.	MAX.	UNITS
Thermal resistance, junction to case	R <sub>thJC</sub>		-	-	0.70	K/W
Thermal resistance, case to heatsink	R <sub>thCS</sub>	Mounting surface, flat, smooth and greased	-	0.2	-	
Weight			-	5.5	-	g
			-	0.2	-	oz.
Mounting torque			1.2 (10)	-	2.4 (20)	N · m (lbf · in)
Marking device		Case style TO-247AC modified	60EPU04			
		Case style TO-247AC	60APU04			

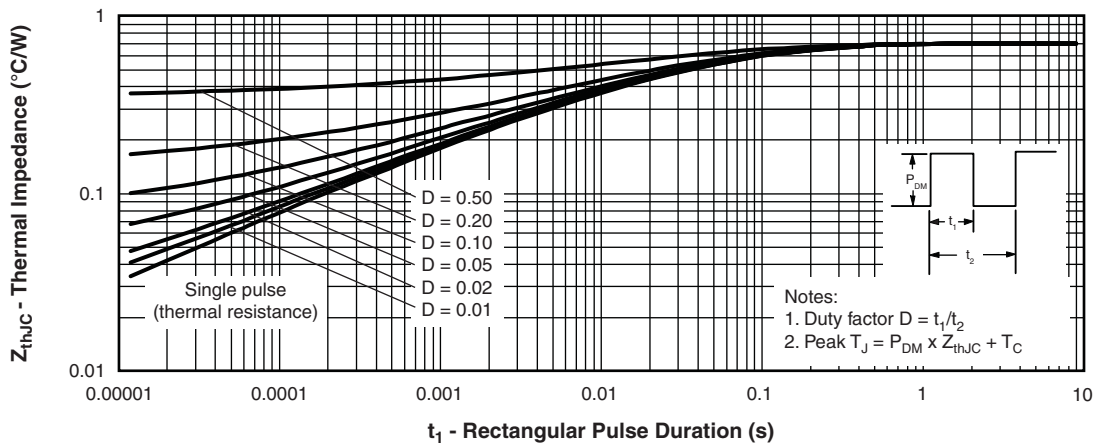
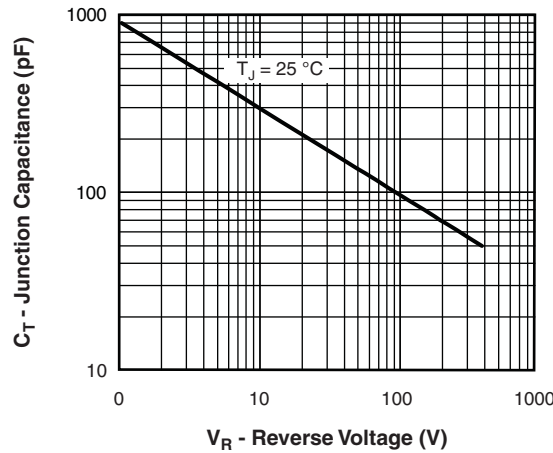
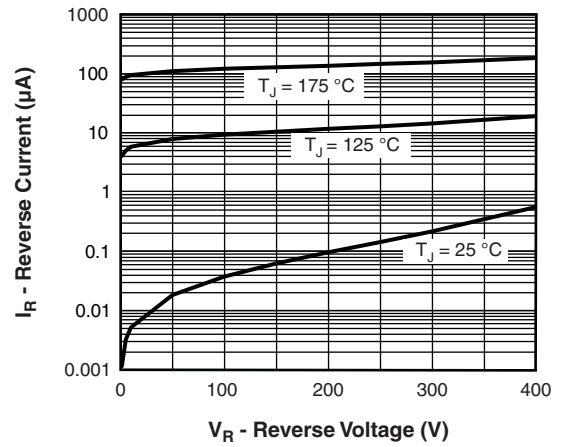
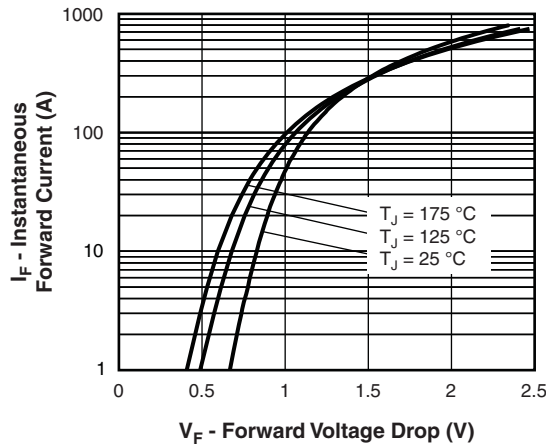

# VS-60EPU04PbF, VS-60APU04PbF



Vishay Semiconductors Ultrafast Soft Recovery Diode,  
60 A FRED Pt®

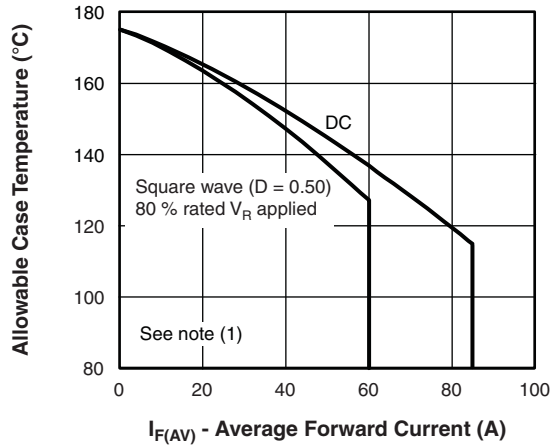

Fig. 5 - Maximum Allowable Case Temperature vs. Average Forward Current

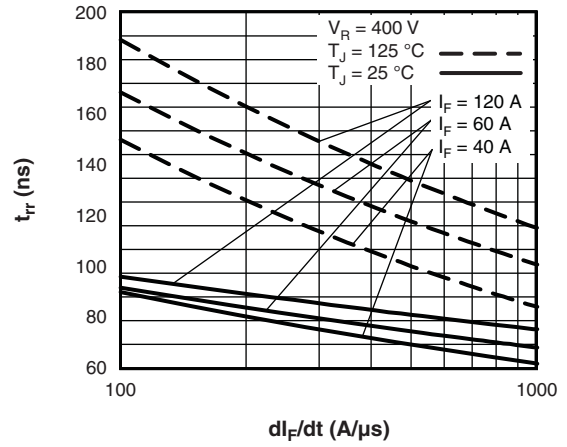

Fig. 7 - Typical Reverse Recovery Time vs.  $di_F/dt$

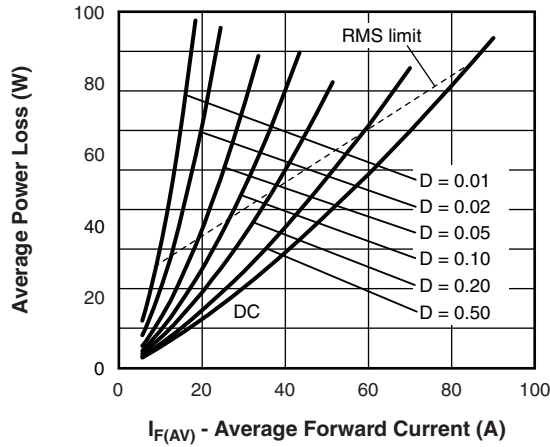

Fig. 6 - Forward Power Loss Characteristics

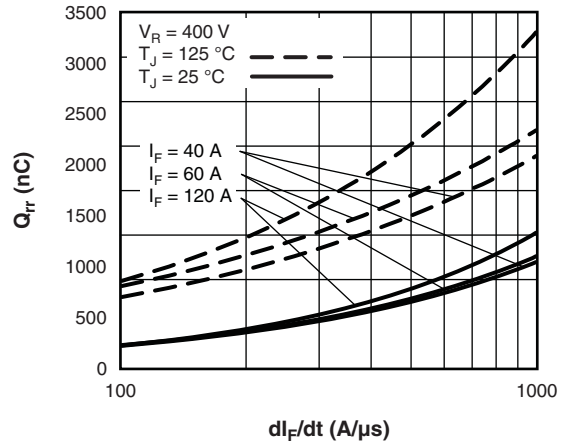

Fig. 8 - Typical Stored Charge vs.  $di_F/dt$

**Note**

- (1) Formula used:  $T_C = T_J - (P_d + P_{d_{REV}}) \times R_{thJC}$ ;  
 $P_d$  = Forward power loss =  $I_{F(AV)} \times V_{FM}$  at  $(I_{F(AV)}/D)$  (see fig. 6);  
 $P_{d_{REV}}$  = Inverse power loss =  $V_{R1} \times I_R (1 - D)$ ;  $I_R$  at  $V_{R1} = 80\%$  rated  $V_R$

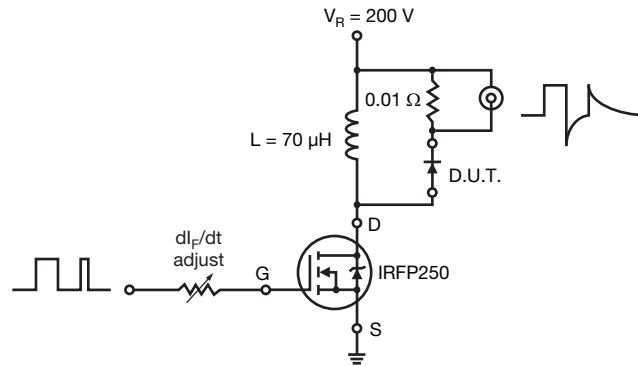
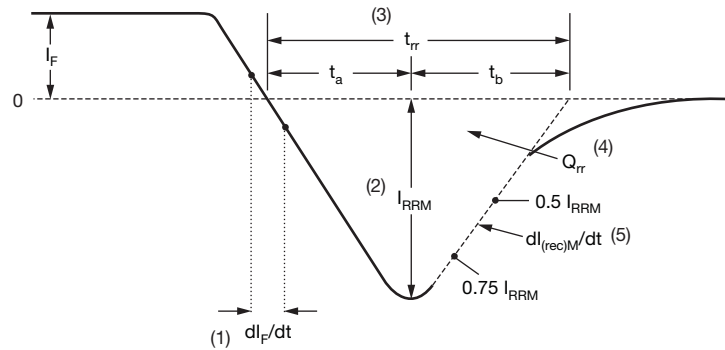

Fig. 9 - Reverse Recovery Parameter Test Circuit



- |  |   |
|--|---|
| <p>(1) <math>di_F/dt</math> - rate of change of current through zero crossing</p> <p>(2) <math>I_{RRM}</math> - peak reverse recovery current</p> <p>(3) <math>t_{rr}</math> - reverse recovery time measured from zero crossing point of negative going <math>I_F</math> to point where a line passing through <math>0.75 I_{RRM}</math> and <math>0.5 I_{RRM}</math> extrapolated to zero current.</p> | <p>(4) <math>Q_{rr}</math> - area under curve defined by <math>t_{rr}</math> and <math>I_{RRM}</math></p> $Q_{rr} = \frac{t_{rr} \times I_{RRM}}{2}$ <p>(5) <math>di_{(rec)M}/dt</math> - peak rate of change of current during <math>t_b</math> portion of <math>t_{rr}</math></p> |
|--|---|

Fig. 10 - Reverse Recovery Waveform and Definitions

# VS-60EPU04PbF, VS-60APU04PbF



Vishay Semiconductors Ultrafast Soft Recovery Diode,  
60 A FRED Pt®

## ORDERING INFORMATION TABLE

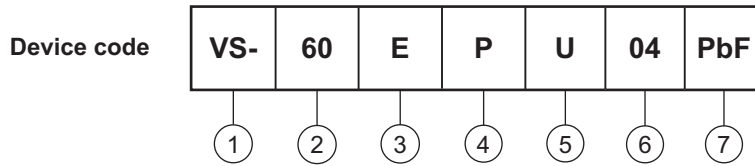

- 1** - Vishay Semiconductors product
- 2** - Current rating (60 = 60 A)
- 3** - Circuit configuration:
  - E = Single diode
  - A = Single diode, 3 pins
- 4** - Package:
  - P = TO-247AC (modified)
- 5** - Type of silicon:
  - U = Ultrafast recovery
- 6** - Voltage rating (04 = 400 V)
- 7** - PbF = Lead (Pb)-free

Tube standard pack quantity: 25 pieces

LINKS TO RELATED DOCUMENTS		
Dimensions	TO-247AC modified	<a href="http://www.vishay.com/doc?95253">www.vishay.com/doc?95253</a>
	TO-247AC	<a href="http://www.vishay.com/doc?95223">www.vishay.com/doc?95223</a>
Part marking information	TO-247AC modified	<a href="http://www.vishay.com/doc?95255">www.vishay.com/doc?95255</a>
	TO-247AC	<a href="http://www.vishay.com/doc?95226">www.vishay.com/doc?95226</a>



## Disclaimer

ALL PRODUCT, PRODUCT SPECIFICATIONS AND DATA ARE SUBJECT TO CHANGE WITHOUT NOTICE TO IMPROVE RELIABILITY, FUNCTION OR DESIGN OR OTHERWISE.

Vishay Intertechnology, Inc., its affiliates, agents, and employees, and all persons acting on its or their behalf (collectively, "Vishay"), disclaim any and all liability for any errors, inaccuracies or incompleteness contained in any datasheet or in any other disclosure relating to any product.

Vishay makes no warranty, representation or guarantee regarding the suitability of the products for any particular purpose or the continuing production of any product. To the maximum extent permitted by applicable law, Vishay disclaims (i) any and all liability arising out of the application or use of any product, (ii) any and all liability, including without limitation special, consequential or incidental damages, and (iii) any and all implied warranties, including warranties of fitness for particular purpose, non-infringement and merchantability.

Statements regarding the suitability of products for certain types of applications are based on Vishay's knowledge of typical requirements that are often placed on Vishay products in generic applications. Such statements are not binding statements about the suitability of products for a particular application. It is the customer's responsibility to validate that a particular product with the properties described in the product specification is suitable for use in a particular application. Parameters provided in datasheets and/or specifications may vary in different applications and performance may vary over time. All operating parameters, including typical parameters, must be validated for each customer application by the customer's technical experts. Product specifications do not expand or otherwise modify Vishay's terms and conditions of purchase, including but not limited to the warranty expressed therein.

Except as expressly indicated in writing, Vishay products are not designed for use in medical, life-saving, or life-sustaining applications or for any other application in which the failure of the Vishay product could result in personal injury or death. Customers using or selling Vishay products not expressly indicated for use in such applications do so at their own risk and agree to fully indemnify and hold Vishay and its distributors harmless from and against any and all claims, liabilities, expenses and damages arising or resulting in connection with such use or sale, including attorneys fees, even if such claim alleges that Vishay or its distributor was negligent regarding the design or manufacture of the part. Please contact authorized Vishay personnel to obtain written terms and conditions regarding products designed for such applications.

No license, express or implied, by estoppel or otherwise, to any intellectual property rights is granted by this document or by any conduct of Vishay. Product names and markings noted herein may be trademarks of their respective owners.